

stocker

www.stockergarden.com

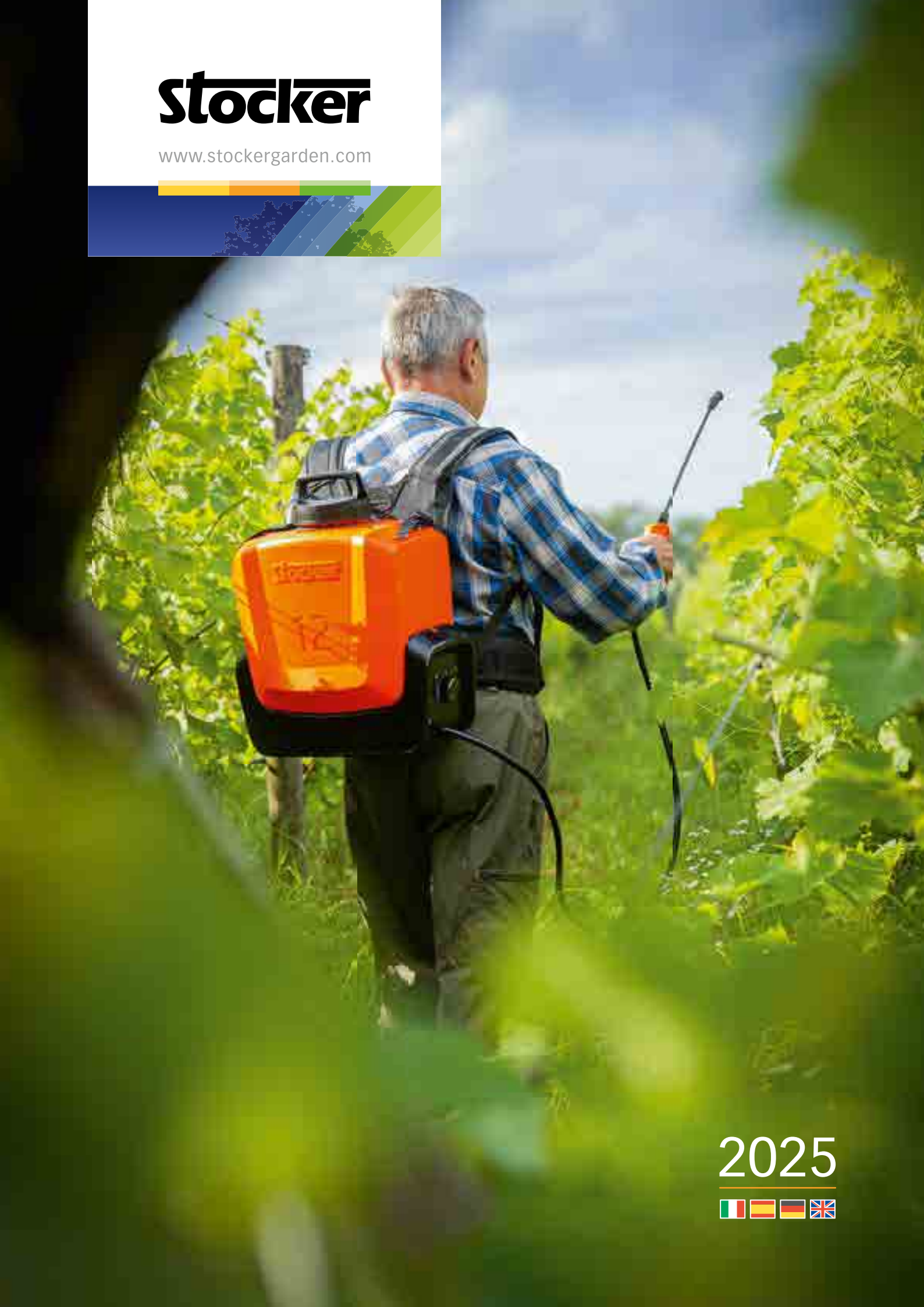

2025



SERVIZIO CLIENTI

SERVICIO CLIENTES
KUNDENSERVICE
CUSTOMER SERVICE

SEMPRE AL VOSTRO FIANCO
SIEMPRE A TU LADO
IMMER AN IHRER SEITE
ALWAYS BY YOUR SIDE

Un team dedicato, a vostra disposizione, che vi assiste e risponde alle richieste di informazioni commerciali e tecniche.

Un team dedicado a su disposición para ayudarlos y responder a las solicitudes de informaciones comerciales y técnicas.

Unser Kundenservice steht Ihnen, bei jeglichen Fragen zu Produkten und Leistungen, gerne zur Verfügung.

Our customer service team is always available to support and answer your technical and commercial questions.

MON - FRI 08.00 - 18.00

✉ info@stockergarden.com

☎ +39 0473 563 277

Via Industria 1/7
39011 Lana (BZ) Italia
T +39 0473 563 277
F +39 0473 563 482
info@stockergarden.com
www.stockergarden.com



Rinnovato il progetto certificato di tutela del clima.

COMPENSATI 27.588 kg di CO₂

Il nostro contributo finanziario è destinato alla riqualificazione del Parco Campo dei Fiori (Varese) abbinato a un progetto di energia solare in India.

Certified climate protection project renewed.

27,588 Kg of CO₂ ARE COMPENSATED

Our financial contribution is for the redevelopment of "Parco Campo dei Fiori" (Varese), combined with a solar energy project in India.

Più informazioni sul progetto:

More information about the project:



stocker

BENVENUTI

BIENVENIDOS
WILLKOMMEN
WELCOME



The logo for Stocker, featuring the word "Stocker" in a bold, black, sans-serif font.

www.stockergarden.com

STORIA AZIENDALE OUR HISTORY

PASSATO, PRESENTE E FUTURO
PAST, PRESENT & FUTURE

Nel 1985 una giovane coppia di Lana, Bolzano, fonda l'azienda Stocker, intraprendendo un viaggio di crescita e innovazione. Sin dalle origini, abbiamo mantenuto una costante attenzione alle necessità dei nostri clienti, focalizzandoci sullo sviluppo di nuovi prodotti e strategie di comunicazione. La generazione alla guida dell'azienda è cambiata, ma l'impegno e l'entusiasmo permangono costanti. Ogni passo in avanti è volto all'innovazione e al miglioramento, mantenendo viva la passione che ha dato vita a questa azienda.

In 1985, a young couple from Lana, province of Bolzano, founded the Stocker company, starting a journey of growth and innovation. From the beginning, we have maintained a constant focus on the needs of our customers, concentrating on the development of new products and communication strategies. The generation at the helm has changed, but the commitment and enthusiasm remain constant. Every step forward is focused on innovation and improvement, keeping alive the passion that gave life to this company.

stocker

www.stockergarden.com



MISSION

INSIEME PER COLTIVARE MEGLIO
GARDENING BETTER, TOGETHER

Sosteniamo le ambizioni di coltivatori e appassionati progettando e sviluppando attrezzi funzionali e all'avanguardia per avere un buon raccolto, delle piante sane e un giardino impeccabile.

We support the ambitions of farmers and hobbyists by designing and developing functional and advanced tools for a good harvest, healthy plants and a perfect garden.



stocker

www.stockergarden.com

VISION

DI GENERAZIONE IN GENERAZIONE FROM GENERATION TO GENERATION

Tramandare e custodire valori, conoscenze e tradizioni nell'ambito della coltivazione delle piante. Ogni coltivatore può raggiungere il suo obiettivo grazie ai consigli e all'esperienza tramandata dagli esperti. Il potere della condivisione ci guida nel trasmettere il sapere di generazione in generazione.

Hand down and preserve values, knowledge and traditions in plant cultivation. Every farmer can achieve his goal thanks to the advice and experience transmitted by the experts. The power of sharing guides us in passing on knowledge from generation to generation.

Stocker

www.stockergarden.com



21 V / **POWER
LINE**

Stocker

PRODOTTI TOP TOP PRODUCTS

Le nostre soluzioni innovative prendono forma nei prodotti TOP. La linea di batterie "STOCKER POWER 21 V" rappresenta un esempio di eccellenza fondato sulla funzionalità e versatilità. Grazie ad una linea di batterie compatibili con un'ampia gamma di attrezzi e prodotti si semplifica il lavoro in giardino e in campo rendendolo più efficace e adattabile a tutte le esigenze. Quest'anno, oltre agli attrezzi per la potatura, la raccolta e le pompe elettriche, la linea di prodotti 21 Volt accoglie nuove soluzioni per la cura e la pulizia della casa e giardino.

Tutti i prodotti top sono supportati dalla promozione all'interno del negozio con espositori, poster e flyer. Online, attraverso pubblicità, landing page e video promozionali. Un pacchetto completo!

Our innovative solutions take shape in TOP products. The „STOCKER POWER 21 V“ battery line represents an example of excellence based on functionality and versatility. A line of batteries compatible with a wide range of tools and products simplifies work in the garden and in the field, making it more effective and adaptable to all needs. This year, in addition to tools for pruning, harvesting and electric sprayers, the 21 Volt Product Line welcomes new solutions for home and garden care and cleaning.

All TOP products are supported by in-store promotion with displays, posters and flyers. Online, through advertising, landing pages and promotional videos. A complete package!

AGENDA 2030

LAVORIAMO PER LA TERRA,
NEL RISPETTO DELLA TERRA.

WE WORK FOR THE EARTH,
RESPECTING THE EARTH.

L'Agenda 2030 è un piano globale adottato dalle Nazioni Unite per promuovere uno sviluppo sostenibile, volto a proteggere il pianeta, ponendosi degli obiettivi specifici entro il 2030.

La certificazione ISO 14064-1, emessa a luglio 2024, che abbiamo nuovamente ottenuto per i nostri impegni nel 2023, attesta la nostra conformità agli standard internazionali per la gestione e la riduzione delle emissioni di gas serra.

In linea con questa politica, ci impegniamo a perseguire un continuo miglioramento delle nostre performance ambientali, cercando di minimizzare ogni impatto negativo verso l'ambiente e mirando alla sostenibilità dei nostri prodotti. Grazie a questo percorso oggi l'azienda è pienamente consapevole del suo impatto climatico. L'impegno è quello di adottare pratiche sostenibili in ogni fase, dalla produzione al consumo, come ad esempio il contributo per la tutela del clima per compensare le emissioni di CO₂ prodotte dalla stampa di questo catalogo.

The 2030 Agenda is a global plan adopted by the United Nations to promote sustainable development, aimed at protecting the planet by setting specific targets by 2030. The ISO 14064-1 certification, issued in July 2024, which we again obtained for our commitments in 2023, attests to our compliance with international standards for the management and reduction of greenhouse gas emissions.

In line with this policy, we are committed to continuously improving our environmental performance, striving to minimise any negative impact on the environment and aiming for sustainability in our products. Thanks to this path, the company is now fully aware of its climate impact. We are committed to adopting sustainable practices at every stage, from production to consumption, such as contributing to climate protection to offset the CO₂ emissions produced by the printing of this catalogue.



stocker

www.stockergarden.com

ASSISTENZA PER OGNI ESIGENZA

ASSISTANCE FOR EVERY NEED

UN TEAM DEDICATO
A WHOLE TEAM

A vostra disposizione
dal lunedì al venerdì
dalle 8 alle 18.

At your service
from Monday to
Friday from 8 AM
to 6 PM.

**IL VOSTRO AGENTE
DI FIDUCIA**
YOUR TRUSTED SALES
REPRESENTATIVE

Conosce le vostre
esigenze e vi assiste
da vicino.

He/She understands
your needs and
supports you on-site.

SPEDIZIONI RAPIDE
QUICK SHIPMENTS

In Italia le nostre
spedizioni vi raggiun-
gono in media entro
48 ore.

In Europe, on
average, our ship-
ments reach you
within 5 business
days.

**IL VOSTRO SPAZIO
DIGITALE**
YOUR DIGITAL SPACE

Con il portale clienti
potete gestire ordini,
documenti e down-
load in ogni
momento.

With the customer
portal, you can
manage orders,
documents and
downloads
anytime.

UN MONDO DI SERVIZI
FULL SERVICE

Per ottimizzare
l'assistenza al consu-
matore finale:

- estensione
della garanzia
- chiamata di servizio
- sviluppo di reti di
centri assistenza
(CAT).

Optimize assis-
tance for the final
consumer.

- Warranty extension
- development of a
network of
assistance centers.





stocker

www.stockergarden.com

UNA COMMUNITY SEMPRE ATTIVA ACTIVE COMMUNITY

COLTIVARE BENE: ATTREZZI E CONOSCENZE
GROWING WELL: TOOLS AND KNOWLEDGE

Far parte della nostra community non significa solo utilizzare i nostri prodotti, ma anche coltivare e condividere esperienze. Le persone che ne fanno parte condividono le proprie passioni partecipando ai corsi di potatura, si scambiano idee e opinioni sui social media, apprendono i consigli degli esperti attraverso il sito web. Crediamo che sia importante rendere le persone consapevoli sia nell'acquisto che nell'utilizzo dei prodotti.

Far parte della nostra community non significa solo utilizzare i nostri prodotti, ma anche coltivare e condividere esperienze. Le persone che ne fanno parte condividono le proprie passioni partecipando ai corsi di potatura, si scambiano idee e opinioni sui social media, apprendono i consigli degli esperti attraverso il sito web. Crediamo che sia importante rendere le persone consapevoli sia nell'acquisto che nell'utilizzo dei prodotti.

Stocker

www.stockergarden.com

LEGENDA

LEYENDA - LEGENDE - LEGEND

INFO

Pz./St.

Pezzi per confezione.
Piezas por caja.
Angabe zur jeweiligen Verpackungseinheit
(Stück pro Karton).
Pieces per carton.

I prezzi indicati sono comprensivi di IVA e si riferiscono al consumatore finale. Salvo variazioni.

El precio indicado se refiere al consumidor final. Salvo variaciones.
Die angeführten Preise sind Endverbraucher-Preise inklusive der gesetzlich vorgeschriebenen Mehrwertsteuer.
Preisänderungen vorbehalten.
Prices are for consumers only. The sales tax is included in the price. Prices may vary.

€

PRODOTTO TOP

Prodotto con campagna promozionale B2C e materiali per il rivenditore.

RECOMENDADO

Prodotto consigliato da Stocker
Producto recomendado por Stocker
Produktempfehlung von Stocker
Recommended product by Stocker

GARANZIA GARANTIA GARANTIE 36 MESI

Il cliente finale può estendere gratuitamente la garanzia fino a 36 mesi. Solo in Italia, Austria, Spagna, Germania.

El cliente final puede extender la garantía de forma gratuita hasta 36 meses. Sólo en Italia, Austria, España, Alemania.
Der Konsument kann die Garantie bis zu 36 Monaten umsonst erweitern. Nur in den Ländern Italien, Österreich, Spanien, Deutschland.
The end user can extend for free the warranty to 36 months. Only in Italy, Austria, Spain, Germany.

CHIAMATA DI SERVIZIO

Assistenza con chiamata di servizio.

DESIGN ADI

Prodotto selezionato per ADI Design Index
Producto seleccionado para ADI Design Index
Für den ADI Design Index ausgewähltes Produkt
Product selected for ADI Design Index



I prodotti vengono venduti solo in scatola intera.
Los productos se venden solo en cajas enteras.
Nur als Kartoneinheit erhältlich.
Available only in mass quantity packaging.



I prodotti in garanzia saranno ritirati solo con lo scontrino di vendita.
Productos en garantía serán retirados solo con el ticket de venta.
Produkte in Garantie werden nur mit Kassenzettel zurückgenommen.
Withdrawals of products only with sales receipt.



vedi pagina
ver en la página
siehe Seite
see on page

Consultare la pagina indicata per informazioni sui ricambi.
Ver la página indicada para informaciones sobre los recambios.
Informationen zu den Ersatzteilen finden Sie auf der angegebenen Seite.
See the indicated page for spare parts information.

122

Maggiori informazioni a pagina
Más informaciones en la página
Mehr Informationen auf Seite
More information on page

GARANZIA GARANTIA GARANTIE 60 MESI

Il cliente finale può acquistare l'estensione di garanzia fino a 60 mesi. Solo in Italia, Austria, Spagna, Germania.

El cliente final puede comprar la extensión de garantía hasta 60 meses. Sólo en Italia, Austria, España, Alemania.
Der Konsument kann die Garantieverlängerung von bis zu 60 Monaten erwerben. Nur in den Ländern Italien, Österreich und Spanien, Deutschland.
The end user can purchase a warranty extension to 60 months. Only in Italy, Austria, Spain, Germany.



Scannerizza il codice QR per più informazioni
Escanea el código QR para más informaciones
QR-Code scannen für mehr Informationen
Scan the QR code for more information

Tutte le immagini hanno scopo puramente illustrativo. Todas las imágenes son sólo para fines ilustrativos.

Enthaltene Bilder dienen ausschließlich zu Illustrationszwecken. All the pictures are for illustrative purpose only.

18
FORBICI LÖWE
TIJERAS LÖWE
LÖWE-SCHEREN
LÖWE SHEARS

32
ATTREZZI A BATTERIA
HERRAMIENTAS A BATERÍA
AKKU-WERKZEUGE
BATTERY TOOLS

76
FORBICI PROFESSIONALI
TIJERAS PROFESIONALES
PROFI-SCHEREN
PROFESSIONAL PRUNING SHEARS

92
TRONCARAMI
CORTARRAMAS
ASTSCHEREN
LOPPERS

96
TAGLIASIEPI
RECORTASETOS
HECKENSCHEREN
HEDGE SHEARS

100
FORBICI AD ASTA LUNGA
TIJERAS DE MANGO LARGO
LANGARMSCHEREN
LONG HANDLED PRUNING SHEARS

106
COMBISYSTEM
KOMBISYSTEM

116
SEGHETTI PROFESSIONALI
SERRUCHOS PROFESIONALES
PROFI-SÄGEN
PROFESSIONAL SAWS

122
POMPE MANUALI
BOMBAS MANUALES
MANUELLE DRUCKPUMPEN
MANUAL SPRAYERS

129
BRUCIA ERBACCE
QUEMADOR DE MALAS HIERBAS
UNKRAUTBRENNER
WEED-KILLER

130
MICROIRRIGAZIONE
MICRORRIEGO
MICRO-BEWÄSSERUNG
MICRO IRRIGATION

139
RACCORDI
CONECTORES
ARMATUREN
GARDEN HOSE VALVES

144
LANCE
LANZAS
BRAUSEN
SPRINKLER HEADS

148
IRRIGATORI
ASPERORES
REGNER
SPRINKLERS

158
ATTREZZI
HERRAMIENTAS
GARTENWERKZEUGE
GARDEN TOOLS

171
KIDS GARDEN

178
LEGATRICI E COLTELLI
ATADORAS Y NAVAJAS
BINDEGERÄTE UND MESSER
BINDERS AND KNIVES

190
LEGACCI
ATADURAS
BINDEMATERIAL
BINDING MATERIAL

198
PROTEZIONE
PROTECCIÓN
ABDECKMATERIALIEN
PROTECTION

220
ACCESSORI GIARDINO
ACCESORIOS PARA JARDÍN
GARTENZUBEHÖR
GARDEN ACCESSORIES

254
BLUMAT

260
ESPOSITORI
EXPOSITORES
VERKAUFSTÄNDER
DISPLAY CASES

266
RICAMBI
RECAMBIOS
ERSATZTEILE
SPARE PARTS

ATTREZZI A BATTERIA
BATTERY TOOLS

FORBICI
SHEARS

TRONCARAMI,
TAGLIASIEPI
LOPPERS,
HEDGE SHEARS

SEGHETTI
PRUNING
SAWS

POMPE
MANUALI
MANUAL
SPRAYERS

IRRIGAZIONE
IRRIGATION

ATTREZZI
TOOLS

LEGATRICI
BINDERS

PROTEZIONE
PROTECTION

ACCESSORI
ACCESSORIES

IRRIGAZIONE
BLUMAT

ESPOSITORI
DISPLAYS

RICAMBI
SPARE PARTS



ORIGINAL
LÖWE
GARDENPRO



CLASSIC

20 | 21 | 22 | 23

PROFESSIONAL

24 | 25 | 26 | 27 | 30

PRECISION

28 | 30

ECONOMIC

29

HUNTING

29

FORBICI ORIGINAL LÖWE

TIJERAS ORIGINAL LÖWE
ORIGINAL LÖWE SCHEREN
ORIGINAL LÖWE PRUNING SHEARS



Art. 1104



Art. 1.104

LÖWE 1 Forbice Amboss
Come modello 1104, con impugnatura curvata per mani più piccole.

LÖWE 1 Tijera de yunque
Como modelo 1104, con empuñadura curvada para manos más pequeñas.

LÖWE 1 Amboss-Schere
Wie Mod. 1104, mit nach innen geschwungenen Kunststoffgriffen.

LÖWE 1 Anvil Pruners
Similar to model type 1104; with inward curved plastic handles. Ideal for smaller hands.

Art.	cm	Gr.	Pz./St.	€	EAN
1107	21	280	5	51,00-	8 016604 011078



- LÖWE 1 Forbice Amboss**
Impugnatura curvata.
- LÖWE 1 Tijera de yunque**
Con empuñadura curvada.
- LÖWE 1 Amboss-Schere**
Mit geschwungenen Kunststoffgriffen.
- LÖWE 1 Anvil Pruners**
With curved plastic handles.

Art.	cm	Gr.	Pz./St.	€	EAN
1105	20	290	5	50,70-	8 016604 011054

1 > THE ORIGINAL

LÖWE 1 Forbice Amboss
Modello standard con impugnatura in plastica.

LÖWE 1 Tijera de yunque
Modelo estándar con mango de plástico.

LÖWE 1 Amboss-Schere
Standardausführung mit Kunststoffgriff.

LÖWE 1 Anvil Pruners
Standard model with plastic handles.



Art.	cm	Gr.	Pz./St.	€	EAN
1104	21	290	5	50,20-	8 016604 011047

LÖWE 1 Forbice Amboss
Modello come Art. 1104 con manico girevole.

LÖWE 1 Tijera de yunque
Modelo como Art.1104 con mango giratorio.

LÖWE 1 Amboss-Schere
Wie Modell Art. 1104 jedoch mit Rollgriff.

LÖWE 1 Anvil Pruners
Similar to model type 1104; with rotating handle.

Art.	cm	Gr.	Pz./St.	€	EAN
1109	21	315	5	68,40-	8 016604 011092

2 > VARIO

LÖWE 2 Forbice Amboss
Forbice con manici regolabili.

LÖWE 2 Tijera de yunque
Tijera con mangos regulables.

LÖWE 2 Amboss-Schere
Robuste Amboss-Schere mit verstellbarer Griffweite.

LÖWE 2 Anvil Pruners
Durable anvil pruning shears with adjustable handles.



Art.	cm	Gr.	Pz./St.	€	EAN
2104	21	290	5	57,20-	8 016604 021046

LÖWE 2 Forbice Amboss
Come modello 2104, con impugnatura curvata per mani più piccole.

LÖWE 2 Tijera de yunque
Como modelo 2104, con empuñadura curvada para manos más pequeñas.

LÖWE 2 Amboss-Schere
Wie Mod. 2104, mit geschwungenen Kunststoffgriffen für kleinere Hände.

LÖWE 2 Anvil Pruners
Similar to model type 2104; with curved handles. Ideal for smaller hands.

Art.	cm	Gr.	Pz./St.	€	EAN
2107	21	280	5	58,20-	8 016604 021077



Art. 2.104

> THE ORIGINAL

L'Original LÖWE 1 è la prima forbice con taglio a battente che Walther Schröder presentò al mondo nel 1923. Ha segnato il punto di partenza, il modello che si è evoluto nei successivi modelli Original LÖWE GardenPro e INDUSTRIAL.

La Original LÖWE 1 es la primera tijera con corte de yunque que Walther Schröder presentó al mundo en 1923. Marcó el punto de partida, el modelo auténtico que evolucionó en muchos otros modelos Original LÖWE GardenPro e INDUSTRIAL.

Die Original LÖWE 1 ist die erste Amboss-Schere, die Walther Schröder 1923 der Welt präsentiert hat. Sie ist der Ursprung und das Original, aus dem viele weitere Original LÖWE-Modelle GardenPRO und INDUSTRIAL entwickelt wurden.

The Original LÖWE 1 is the first anvil pruner that Walther Schröder presented to the world in 1923. It marked the starting point, the authentic model that evolved into many other Original LÖWE GardenPro and INDUSTRIAL models.

> VARIO

Classica forbice con taglio a battente e manici regolabili in larghezza per adattarsi alle dimensioni della mano. Maggiore durata della forbice, perché l'usura di lama e battente può essere compensata regolando i manici in posizioni differenti.

Tijera con corte de yunque y mango regulables en longitud para adaptarse al tamaño de su mano. Mayor duración de la tijera, ya que el desgaste de la hoja y la contra hoja se puede compensar ajustando los mangos en diferentes posiciones.

Klassische Amboss-Schere mit stufenloser Griffweitenverstellung zur Anpassung an die eigene Handgröße. Die Nutzungsdauer von Klinge und Amboss wird deutlich verlängert, weil deren Verschleiß durch die Griffweitenverstellung ausgeglichen werden kann.

Classic anvil pruner with continuously adjustable handle width to match your hand size. The service life of the blade and anvil is significantly extended as the adjustable handle width compensates for wear.



Art. 5.107

5 > EASY CUT

- ☑ **LÖWE 5 Forbice Amboss Baby**
Taglia rami fino a 16 mm.
- ☑ **LÖWE 5 Tijera de yunque Baby**
Pequeña tijera de yunque, corta ramas hasta los 16 mm de diámetro, muy ligera.
- ☑ **LÖWE 5 Amboss-Schere Baby**
Kleine Amboss-Schere. Sie schneidet Äste bis 16 mm Durchmesser, verblüffend leicht.
- ☑ **LÖWE 5 Anvil Pruners Baby**
Cuts branches up to 16 mm in diameter.



Art.	cm	Gr.	Pz./St.	€	EAN
5104	17,5	175	5	39,15-	8 016604 051043

- ☑ **LÖWE 5 Forbice Amboss Baby**
Come modello 5104, con impugnatura curvata per mani più piccole.
- ☑ **LÖWE 5 Tijera de yunque Baby**
Como modelo 5104, con empuñadura curvada para manos más pequeñas.
- ☑ **LÖWE 5 Amboss-Schere Baby**
Wie Mod. 5104, mit nach innen geschwungenen Kunststoffgriffen für kleinere Hände.
- ☑ **LÖWE 5 Anvil Pruners Baby**
Similar to model type 5104 with inward curved plastic handles. Ideal for smaller hands.

- ☑ **LÖWE 5 Forbice Amboss Baby**
Modello come Art. 5104 con manico girevole.
- ☑ **LÖWE 5 Tijera de yunque Baby**
Modelo como art. 5104, con mango giratorio.
- ☑ **LÖWE 5 Amboss-Schere Baby**
Wie Mod. 5104 jedoch mit Rollgriff.
- ☑ **LÖWE 5 Anvil Pruners Baby**
Similar to model type 5104 with rotating handle.



Art.	cm	Gr.	Pz./St.	€	EAN
5107	17,5	175	5	39,55-	4 033119 000650



Art.	cm	Gr.	Pz./St.	€	EAN
5109	17,5	210	5	52,90-	8 016604 051098

- ☑ **LÖWE 5 Forbice Amboss Baby**
Come modello 5107, con lama a punta.
- ☑ **LÖWE 5 Tijera de yunque Baby**
Como modelo 5107, con hoja de punta.
- ☑ **LÖWE 5 Amboss-Schere Baby**
Wie Mod. 5107, mit spitzer Klinge.
- ☑ **LÖWE 5 Anvil Pruners Baby**
Similar to model type 5107 with pointed blades.



Art.	cm	Gr.	Pz./St.	€	EAN
5127	18	175	5	45,00-	8 016604 051272

> EASY CUT

- ☑ Le forbici con taglio a battente con lama corta e sottile tagliano molto facilmente, poiché il ramo viene afferrato vicino al fulcro per ottimizzare la trasmissione della forza. La lama sottile si infila più facilmente nel legno, riducendo quindi la forza necessaria per il taglio.
- ☑ Las tijeras de yunque con una hoja corta y delgada cortan muy fácilmente, ya que la rama se agarra cerca del punto de apoyo para optimizar la transmisión de la fuerza. La hoja delgada corta la madera más fácilmente, reduciendo así la fuerza requerida para cortar.
- ☑ Amboss-Scheren mit kurzer und schlanker Klinge schneiden sehr leicht, weil das Schnittgut nahe an der Lagerung liegt und damit die Kraftübersetzung optimal ist. Zusätzlich keilt eine dünne Klinge den zu schneidenden Ast weniger auf. Damit ist auch der Kraftaufwand für den Schnitt nochmals geringer.
- ☑ Anvil pruners with a short and slim blade cut very easily as the material is grasped close to the hinge for optimised force transmission. A slim blade displaces less material and therefore reduces the required cutting force even more.

10 > POWER CUT

- ☑ **LÖWE 10 Forbice Amboss**
Con lama curva che riduce lo sforzo nel taglio e impugnatura curvata per mani più piccole. Diametro di taglio: 30 mm.
- ☑ **LÖWE 10 Tijera de yunque**
Con hoja curvada que reduce el esfuerzo en el corte y empuñadura curvada para manos más pequeñas. Diámetro de corte: 30 mm.
- ☑ **LÖWE 10 Amboss-Schere**
Mit gebogener Klinge, welche den Kraftaufwand reduziert und nach innen geschwungenen Kunststoffgriffen für kleinere Hände. Schnittdurchmesser: 30 mm.
- ☑ **LÖWE 10 Anvil Pruners**
With curved blade that reduces the strain of cutting and inward curved handles for smaller hands. Cutting diameter: 30 mm.



Art.	cm	Gr.	Pz./St.	€	EAN
10107	21	285	5	51,90-	4 033119 005006



Massima capacità di taglio con la massima potenza!

Ø 30 mm

Maximum cutting capacity with maximum power!



> POWER CUT

- ☑ Le forbici ibride combinano il meccanismo di taglio a battente con geometria bypass. La forma curva della lama e del battente permette di potare rami di grande diametro vicino al tronco senza che esso scivoli in avanti durante il taglio. Questo garantisce un miglior trasferimento della forza della mano, riducendo notevolmente lo sforzo e lo stress su mano e polso durante il lavoro.
- ☑ Las tijeras híbridas combinan el mecanismo de corte de yunque con una hoja curva. Gracias a la forma curvada de la hoja y la placa base, permite de podar ramas de gran diámetro cerca del tronco sin que se deslice hacia adelante durante el corte. Esto garantiza una mejor transferencia de la fuerza de la mano, reduciendo considerablemente el esfuerzo y el estrés en la mano y muñeca durante el trabajo.
- ☑ Hybrid-Scheren sind Amboss-Scheren mit Bypass-Geometrie. Sie vereinen das Beste aus zwei Welten. Aufgrund der gebogenen Form der Klinge und Unterlage liegt auch Schnittgut mit großem Durchmesser dicht an der Lagerung und rutscht beim Schnitt nicht nach vorne. Durch diese ideale Kraftübertragung können auch kräftige Äste aus hartem Holz mühelos geschnitten werden.
- ☑ The hybrid shears combine the anvil cutting mechanism with bypass geometry. The curved shape of the blade and wing allows large-diameter branches to be pruned close to the tree without it sliding forward during cutting. This ensures better transfer of hand force, significantly reducing effort and stress on the hand and wrist during work.

6 > FAST CUT







Art. 6.107

-  **LÖWE 6 Forbice Amboss**
Forbice professionale con taglio a battente con manici regolabili e lama facilmente sostituibile senza smontare la forbice.
-  **LÖWE 6 Tijera de yunque**
Tijera profesional con corte de yunque con mangos ajustables y hoja fácilmente reemplazable sin desmontar la tijera.
-  **LÖWE 6 Amboss-Schere**
Profi-Amboss-Schere mit stufenlos verstellbarer Griffweite und schnell auswechselbarer Klinge ohne Demontage der Schere.
-  **LÖWE 6 Anvil Pruners**
Professional anvil shears with adjustable handles and quick replacement of the blade, without disassembling the shears.







Art.	cm	Gr.	Pz./St.	€	EAN
6104	20	230	5	63,30-	8 016604 061042

-  **LÖWE 6 Forbice Amboss**
Come modello 6104, con impugnatura curvata per mani più piccole.
-  **LÖWE 6 Tijera de yunque**
Como modelo 6104, con empuñadura curvada para manos más pequeñas.
-  **LÖWE 6 Amboss-Schere**
Wie Mod. 6104, jedoch mit nach innen geschwungenen Griffen für kleinere Hände.
-  **LÖWE 6 Anvil Pruners**
Similar to model 6104, with curved handles for smaller hands.



Art.	cm	Gr.	Pz./St.	€	EAN
6107	20	230	5	63,30-	8 016604 061073

-  **LÖWE 6 Forbice Amboss**
Modello come Art. 6104 con manico girevole.
-  **LÖWE 6 Tijera de yunque**
Modelo como Art. 6104 con mango giratorio.
-  **LÖWE 6 Amboss-Schere**
Wie Modell Art. 6104 jedoch mit Rollgriff.
-  **LÖWE 6 Anvil Pruners**
Similar to model Art. 6104, with rotating handle.







Art.	cm	Gr.	Pz./St.	€	EAN
6109	20	260	5	80,90-	8 016604 061097



Art. 7104





> FAST CUT

-  Le forbici con taglio a battente con lama dritta consentono di lavorare velocemente. La lama dritta permette di tagliare il ramo con più precisione e rapidità rendendo più efficienti i lavori di potatura.
-  Las tijeras de yunque con hoja recta permiten trabajar con rapidez. La hoja recta permite cortar la rama con más precisión y rapidez, para una mayor eficiencia.
-  Amboss-Scheren mit gerader Klinge ermöglichen ein schnelles Arbeiten. Durch die gerade Klinge wird das Schnittgut und die gewünschte Schnittstelle sicher getroffen. Das schnelle und sichere Treffen der Schnittstelle macht die Schneidarbeit sehr effizient.
-  Anvil pruners with a straight blade enable fast work. The material is cut at precisely the right point thanks to the straight blade. This fast and accurate cut brings added efficiency to pruning tasks.

7 > EASY CUT







Art. 7.107

-  **LÖWE 7 Forbice Amboss**
Con lama curva e corta, più vicina al perno, che riduce lo sforzo nel taglio. Manici regolabili.
-  **LÖWE 7 Tijera de yunque**
Con hoja curva y corta, más cerca del pasador, que reduce el esfuerzo de corte. Mangos ajustables.
-  **LÖWE 7 Amboss-Schere**
Eine kleine und gekrümmte Klinge verringert den Kraftaufwand durch das Schneiden näher am Zentralbolzen.
-  **LÖWE 7 Anvil Pruners**
With curved and short blade, that reduces the strain during cutting. With adjustable handles.







Art.	cm	Gr.	Pz./St.	€	EAN
7104	20	220	5	64,70-	4 033119 000803

-  **LÖWE 7 Forbice Amboss**
Come modello Art. 7104, con impugnatura curvata per mani più piccole.
-  **LÖWE 7 Tijera de yunque**
Como modelo Art. 7104, con empuñadura curvada para manos más pequeñas.
-  **LÖWE 7 Amboss-Schere**
Wie Modell Art. 7104, mit nach innen geschwungenen Kunststoffgriffen für kleinere Hände.
-  **LÖWE 7 Anvil Pruners**
Similar to model type 7104, with curved handles for smaller hands.





Art.	cm	Gr.	Pz./St.	€	EAN
7107	20	220	5	64,70-	4 033119 000810



-  **LÖWE 7 Forbice Amboss**
Come modello Art. 7104, con manico girevole.
-  **LÖWE 7 Tijera de yunque**
Como modelo Art. 7104, con mango giratorio.
-  **LÖWE 7 Amboss-Schere**
Wie Modell Art. 7104 jedoch mit Rollgriff.
-  **LÖWE 7 Anvil Pruners**
Similar to model type 7104 with rotating handle.



Art.	cm	Gr.	Pz./St.	€	EAN
7109	20	250	5	81,20-	4 033119 000827

> CLEAN CUT

-  Le forbici con taglio a passante afferrano il ramo solo da un lato, venendo poi trattenuto dalla controlama mentre la lama principale esegue il taglio. La loro geometria consente di eseguire un taglio pulito e preciso alla base del ramo. Le forbici a taglio passante sono particolarmente adatte per lavori di precisione e per piante più fibrose che non necessitano di forza nel taglio.
-  Las tijeras de corte pasante agarran la rama solo por un lado y luego la sujetan con la contra hoja mientras la hoja principal hace el corte. Su geometría permite una poda neta y precisa. Las tijeras de corte pasante son especialmente adecuadas para los trabajos de precisión y para plantas fibrosas que no necesitan fuerza en el corte.

-  Bei Bypass-Scheren wird das Schnittgut nur auf einer Seite von der Gegenklinge gehalten, während die Klinge das Schnittgut durchtrennt. Aus diesem Grund wird der geschnittene Ast auch nur auf einer Seite gequetscht und die Seite der Schnittstelle an der Pflanze bleibt ohne Verletzung. Ihre Geometrie ermöglicht ein Abschneiden bündig an der Austriebstelle bzw. einen sauberen Schnitt am Asttring. Bypass-Scheren eignen sich besonders bei faserigen und empfindlichen Gehölzen.
-  Bypass pruners only grasp the material on one side, so it is held by the counter blade while the main blade performs the cut. This means that the branch is also only squeezed on one side, while the cut side of the branch is left unharmed. Their geometry permits flush separation at the sprouting point or a clean cut on the branch ring. Bypass pruners are particularly suitable for use on fibrous and sensitive wood.



Art. 8.107

LÖWE 8 Forbice Amboss
Forbice con lama curva che facilita il taglio.

LÖWE 8 Tijera de yunque
Tijera con hoja curva para facilitar el corte.

LÖWE 8 Amboss-Schere
Amboss-Schere mit gebogener Klinge für optimalen Halt des Schnittgutes beim Schneiden.

LÖWE 8 Anvil Pruners
Shears with curved blade that makes cutting easier.



Art.	cm	Gr.	Pz./St.	€	EAN
8104	21	230	5	66,80-	8 016604 081040

LÖWE 8 Forbice Amboss
Modello come Art. 8104, con impugnatura curvata per mani più piccole.

LÖWE 8 Tijera de yunque
Modelo como Art. 8104, con empuñadura curvada para manos más pequeñas.

LÖWE 8 Amboss-Schere
Wie Modell 8104, mit nach innen geschwungenen Kunststoffgriffen für kleinere Hände.

LÖWE 8 Anvil Pruners
Similar to model type 8104 with curved handles. Ideal for smaller hands.

LÖWE 8 Forbice Amboss
Modello come Art. 8104, con manico girevole.

LÖWE 8 Tijera de yunque
Modelo como Art. 8104, con mango giratorio.

LÖWE 8 Amboss-Schere
Wie Modell 8104 jedoch mit Rollgriff.

LÖWE 8 Anvil Pruners
Similar to model type 8104 with rotating handle.



Art.	cm	Gr.	Pz./St.	€	EAN
8109	21	330	5	89,30-	4 033119 000728



Art.	cm	Gr.	Pz./St.	€	EAN
8107	21	230	5	66,80-	8 016604 081071



Art. 9.104

LÖWE 9 Forbice Bypass
Forbice leggera in cromo vanadium.

LÖWE 9 Tijera Bypass
Tijera ligera de cromo vanadium.

LÖWE 9 Bypass-Schere
Bypass-Schere für sauberen und präzisen Schnitt.

LÖWE 9 Bypass Pruners
Light shears in chromium-vanadium steel. Low weight.



Art.	cm	Gr.	Pz./St.	€	EAN
9104	21	230	5	71,00-	8 016604 091049

LÖWE 9 Forbice Bypass
Come modello 9104, con impugnatura curvata per mani più piccole.

LÖWE 9 Tijera Bypass
Como modelo 9104, con empuñadura curvada para manos más pequeñas.

LÖWE 9 Bypass-Schere
Wie Modell 9104, jedoch mit nach innen geschwungenen Griffen für kleinere Hände.

LÖWE 9 Bypass Pruners
Similar to model type 9104, with inward curved plastic handles. Ideal for smaller hands.

LÖWE 9 Forbice Bypass
Modello come Art. 9104 con manico girevole.

LÖWE 9 Tijera Bypass
Modelo como Art. 9104 con mango giratorio.

LÖWE 9 Bypass-Schere
Wie Mod. Art. 9104, jedoch mit Rollgriff.

LÖWE 9 Bypass Pruners
Similar to model type Art. 9104 with rotating handle.



Art.	cm	Gr.	Pz./St.	€	EAN
9107	21	230	5	71,00-	8 016604 091070



Art.	cm	Gr.	Pz./St.	€	EAN
9109	21	270	5	86,10-	8 016604 091094



Larghezza dei manici regolabile
Prolunga notevolmente la durata della lama, perché l'usura può essere compensata regolando la larghezza dell'impugnatura. Si adatta alle dimensioni della mano dell'operatore.

Mangos regulables en anchura
Prolonga considerablemente la vida útil de la hoja, ya que el desgaste puede compensarse ajustando la anchura del mango. Se ajusta al tamaño de la mano del operador.

Stufenlose Griffweitenverstellung
Deutlich verlängerte Nutzungsdauer der Klinge, da der Verschleiß durch die Griffweitenverstellung ausgeglichen werden kann. Außerdem lässt sich die Schere an die eigene Handgröße anpassen.

Adjustable handle width
Extends the life of the blade considerably, because wear can be compensated by adjusting the handle width. Adjustment to the user's hand size.



Lama facile da sostituire
La lama posizionata esternamente è fissata con un solo dado, rendendo la sostituzione facile e veloce.

Hoja fácil de sustituir
La hoja externa se fija con una sola tuerca, lo que facilita y agiliza su sustitución.

Leicht austauschbare Klinge
Die außenliegende Klinge ist mit nur einer Mutter fixiert und somit vor Ort schnell und leicht auswechselbar.

Easy-to-replace blade
The externally-positioned blade is fastened with just a single nut, making replacement fast and easy.

PRECISION



Art. 11.107

11 12 > CLEAN CUT / SMALL

☑ **LÖWE 11 Forbice Bypass**
Di alta qualità. Tecnologia con bullone autolubrificante. Forbice leggera.

☑ **LÖWE 11 Tijera Bypass**
De alta calidad. Tecnología con tornillo autolubricante - estudiada para el profesional y el jardinero. Tijera ligera.

☑ **LÖWE 11 Bypass-Schere**
Bis ins letzte Detail optimiert, mit optimaler Schneidegeometrie. Geringes Gewicht.

☑ **LÖWE 11 Bypass Pruners**
High quality. Technology with self-lubricating bolts. Designed for the professional and the gardener. Low weight.



Art.	cm	Gr.	Pz./St.	€	EAN
11104	21	200	5	60,70-	8 016604 111044

☑ **LÖWE 11 Forbice Bypass**
Modello come Art. 11104 con manico girevole.

☑ **LÖWE 11 Tijera Bypass**
Modelo como Art. 11104 con mango giratorio.

☑ **LÖWE 11 Bypass-Schere**
Wie Modell Art. 11104 jedoch mit Rollgriff.

☑ **LÖWE 11 Bypass Pruners**
Similar to model type 11104 with rotating handle.

☑ **LÖWE 11 Forbice Bypass**
Con manici incurvati verso l'interno per mani più piccole.

☑ **LÖWE 11 Tijera Bypass**
Con mangos curvados hacia adentro para manos más pequeñas.

☑ **LÖWE 11 Bypass-Schere**
Mit nach innen geschwungenen Kunststoffgriffen für kleinere Hände.

☑ **LÖWE 11 Bypass Pruners**
With inward curved handles for smaller hands.



Art.	cm	Gr.	Pz./St.	€	EAN
11107	21	210	5	60,70-	4 033119 0005013



Art.	cm	Gr.	Pz./St.	€	EAN
11109	21	268	5	81,70-	8 016604 111099

☑ **LÖWE 12 Forbice Bypass**
Modello come Art. 12104 con manico girevole.

☑ **LÖWE 12 Tijera Bypass**
Modelo como Art. 12104 con mango giratorio.

☑ **LÖWE 12 Bypass-Schere**
Wie Modell Art. 12104 jedoch mit Rollgriff.

☑ **LÖWE 12 Bypass Pruners**
Similar to model type 12104 with rotating handle.

☑ **LÖWE 12 Forbice Bypass**
Di alta qualità. Tecnologia con bullone autolubrificante. Forbice leggera.

☑ **LÖWE 12 Tijera Bypass**
De alta calidad. Tecnología con tornillo autolubricante - estudiada para el profesional y el jardinero. Tijera ligera.

☑ **LÖWE 12 Bypass-Schere**
Bis ins letzte Detail optimiert, mit optimaler Schneidegeometrie. Geringes Gewicht.

☑ **LÖWE 12 Bypass Pruners**
High quality. Technology with self-lubricating bolts. Designed for the professional and the gardener. Low weight.



Art.	cm	Gr.	Pz./St.	€	EAN
12109	19	292	5	71,80-	8 016604 121098



Art.	cm	Gr.	Pz./St.	€	EAN
12104	19	230	5	58,20-	8 016604 121043

14 > CLEAN CUT

☑ **LÖWE 14 Forbice Bypass compatta**

☑ **LÖWE 14 Tijera Bypass compacta**

☑ **LÖWE 14 Bypass-Schere kompakt**

☑ **LÖWE 14 Compact Bypass Pruners**



Art.	cm	Gr.	Pz./St.	€	EAN
14104	19	180	5	41,80-	4 033119 000865

ECONOMIC

☑ **LÖWE 14 Forbice Bypass compatta**
Con manici incurvati verso l'interno.

☑ **LÖWE 14 Tijera Bypass compacta**
Con mangos curvados hacia adentro.

☑ **LÖWE 14 Bypass-Schere kompakt**
Mit nach innen geschwungenen Griffen.

☑ **LÖWE 14 Compact Bypass Pruners**
With handles curved inwards.



Art.	cm	Gr.	Pz./St.	€	EAN
14107	19	180	5	41,80-	4 033119 000872

15 > POWER CUT

☑ **LÖWE 15 Forbice Amboss compatta**
Con lama curva.

☑ **LÖWE 15 Tijera de yunque compacta**
Con hoja curva.

☑ **LÖWE 15 Amboss-Schere kompakt**
Mit gebogener Klinge.

☑ **LÖWE 15 Compact Anvil Pruners**
With curved blade.



Art.	cm	Gr.	Pz./St.	€	EAN
15104	19	190	5	41,80-	4 033119 000889

☑ **LÖWE 15 Forbice Amboss compatta**
Con lama curva, con manici incurvati verso l'interno.

☑ **LÖWE 15 Tijera de yunque compacta**
Con hoja curva, mangos curvados hacia adentro.

☑ **LÖWE 15 Amboss-Schere kompakt**
Mit gebogener Klinge, mit nach innen geschwungenen Griffen.

☑ **LÖWE 15 Compact Anvil Pruners**
With curved blade, with handles curved inwards.



Art.	cm	Gr.	Pz./St.	€	EAN
15107	19	190	5	41,80-	4 033119 000896

1 > CLASSIC

☑ **LÖWE 1 Forbice da caccia CLASSIC**
Lama dritta e taglio a battente.

☑ **LÖWE 1 Tijera de caza CLASSIC**
Hoja recta y corte de yunque.

☑ **LÖWE 1 Jagdschere CLASSIC**
Amboss-Schere mit gerade Klinge.

☑ **LÖWE 1 CLASSIC Hunting Shears**
Straight blade with anvil cut.

★ NEW



Art.	cm	Gr.	Pz./St.	€	EAN
1117	20	280	5	50,20-	4 033119 000858

HUNTING



(c) pixabay.com - cocoparisienne

15 > EASY CLEAN

☑ **LÖWE 15 Forbice da caccia EASY CLEAN**
Con lama curva.

☑ **LÖWE 15 Tijera de caza EASY CLEAN**
Con hoja curvada.

☑ **LÖWE 15 Jagdschere EASY CLEAN**
Mit gebogener Klinge.

☑ **LÖWE 15 EASY CLEAN Hunting Shears**
With curved blade.

★ NEW



Art.	cm	Gr.	Pz./St.	€	EAN
15114	20	190	5	41,80-	4 033119 005129

69 > POWER CUT

☑ **LÖWE Troncarami da caccia Amboss**

☑ **LÖWE Cortarramas de caza de yunque**

☑ **LÖWE Amboss Jagdschere**

☑ **LÖWE Anvil Hunting lopper**

★ NEW



Art.	cm	Gr.	Pz./St.	€	EAN
69150	50	915	6	108,50-	4 033119 005020

PROFESSIONAL



Art. 70.080

69 > POWER CUT

LÖWE Troncarami Amboss Profi
Taglia rami fino a Ø 50 mm.

LÖWE Cortarramas de yunque Profi
Corta ramas hasta Ø 50 mm.

LÖWE Profi Amboss-Astscherer
Schneidet Äste bis zu Ø 50 mm.

LÖWE Anvil lopper Profi
Cuts branches up to 50 mm.

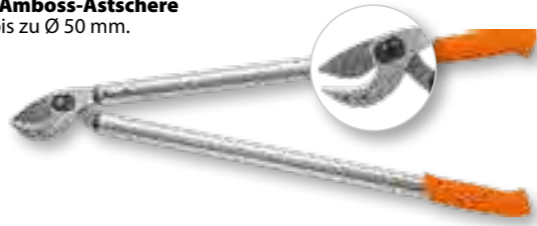

Art.	cm	Gr.	Pz./St.	€	EAN
69050	50	950	6	108,50-	4 033119 220508
69065	65	1.100	6	112,50-	4 033119 220652
69080	80	1.216	6	116,50-	4 033119 220805
69100	100	1.400	6	120,50-	4 033119 221000

70 > FAST CUT

LÖWE Troncarami Amboss Profi
Taglia rami fino a Ø 45 mm.

LÖWE Cortarramas de yunque Profi
Corta ramas hasta Ø 45 mm.

LÖWE Profi Amboss-Astscherer
Schneidet Äste bis zu Ø 45 mm.

LÖWE Anvil lopper Profi
Cuts branches up to 45 mm.



Art.	cm	Gr.	Pz./St.	€	EAN
70050	50	850	6	101,50-	4 033119 200500
70065	65	990	6	106,00-	4 033119 200654
70080	80	1.120	6	110,00-	4 033119 200807
70100	100	1.300	6	114,50-	4 033119 201002

71 > CLEAN CUT

LÖWE Troncarami Bypass
Taglia rami fino a Ø 45 mm.

LÖWE Cortarramas Bypass
Corta ramas hasta Ø 45 mm.

LÖWE Bypass-Astscherer
Schneidet Äste bis zu Ø 45 mm.

LÖWE Bypass lopper
Cuts branches up to 45 mm.



Art.	cm	Gr.	Pz./St.	€	EAN
71050	50	850	6	112,50-	4 033119 210509
71065	65	990	6	114,50-	4 033119 210653
71080	80	1.120	6	117,50-	4 033119 210806

PRECISION



Art. 31.050

31 > CLEAN CUT

LÖWE Troncarami Bypass
Taglia rami fino a Ø 35 mm.

LÖWE Cortarramas Bypass
Corta ramas hasta Ø 35 mm.

LÖWE Bypass-Astscherer
Schneidet Äste bis zu Ø 35 mm.

LÖWE Bypass lopper
Cuts branches up to 35 mm.



Art.	cm	Gr.	Pz./St.	€	EAN
31040	40	600	12	72,90-	4 033119 310407
31050	50	670	12	77,50-	4 033119 310506
31060	60	740	12	81,70-	4 033119 310605

LÖWE Fodero in pelle per forbici
100% vera pelle.

LÖWE Funda de cuero para tijeras
100% cuero auténtico.

LÖWE Lederholster für Scheren
100% echtes Leder.

LÖWE leather holster for pruning shears
100% genuine leather.



★ NEW

Art.	cm	Gr.	Pz./St.	€	EAN
9809	23	125	1	45,50-	4 033119 005082



LÖWE Affilalame
Massime prestazioni di affilatura grazie all'affilatore in metallo duro.

LÖWE Afilador
Máximo rendimiento de afilado gracias al afilador de metal duro.

LÖWE Messerschärfer
Maximale Schärfeleistung durch den Präzisions-Hartmetalleinsatz.

LÖWE Sharpener
Maximum sharpening performance thanks to the precision carbide inlay.



Art.	cm	Gr.	Pz./St.	€	EAN
0022	14	26	1	20,90-	8 016604 000225

LÖWE Affilatore a diamante
Lunga durata. Per affilare senza smontare la lama.

LÖWE Afilador de diamante
Larga duración. Para afilar sin desmontar la hoja.

LÖWE Diamantfeile
Hoher Lebensdauer. Schärfen auch in eingebautem Zustand.

LÖWE diamond sharpener
Very long service life. Sharpening without disassembly of the blade.

★ NEW



Art.	cm	Gr.	Pz./St.	€	EAN
0023	15	12	1	19,05-	4 033119 005136

LÖWE Espositore 80 cm
120 pz assortiti.

LÖWE Expositor 80 cm
120 pzs surtidas.

LÖWE Verkaufsständer 80 cm
120 St., gemischt.

LÖWE Display 80 cm
120 assorted pieces.



★ NEW

Art.	cm	Pz./St.	€	EAN
9912	80 x 47 x h 200			4 033119 003217

LÖWE Espositore per forbici
12 pz assortiti / 2 modelli forbici Löwe

LÖWE Expositor para tijeras
12 pzs surtidas / 2 modelos de tijeras Löwe

LÖWE Verkaufsständer für Scheren
12 St., gemischt / 2 Löwe Modelle

LÖWE Display for Pruners
12 assorted pieces / 2 Löwe model types



Art.	cm	Pz./St.	€	EAN
9975	45 x 23 x h 47			4 033119 003538

* fino ad esaurimento
* hasta agotamiento
* solange der Vorrat reicht
* While supplies last



ATTREZZI A BATTERIA

HERRAMIENTAS A BATERÍA
AKKU-WERKZEUGE
BATTERY TOOLS

INDICE ATREZZI 21 V

ÍNDICE DE HERRAMIENTAS 21 V
INHALTSVERZEICHNIS 21 V GERÄTE
21 V TOOLS INDEX

21V POWER
LINE
Stocker

Art.	Pz./St.	€	EAN	
------	---------	---	-----	--

- Forbice Magma E-35 TP 21 V**
- Tijera Magma E-35 TP 21 V
- Schere Magma E-35 TP 21 V**
- Pruning shears Magma E-35 TP 21 V



621 2 274,00- 8 016604006210 42

- Manico telescopico orientabile Magma**
- Mango giratorio telescópico Magma
- Teleskopstiel Magma mit Kugelgelenk**
- Magma Telescopic Swivel Handle



584 1 219,00- 8 016604005848 42

- Manico telescopico Magma**
- Mango telescópico Magma
- Teleskopstiel Magma**
- Magma telescopic handle



580 2 184,00- 8 016604005800 42



581 1 215,00- 8 016604005817 42

- Abbacchiatore telescopico 235-315 Magma E-51 21 V**
- Vareador telescópico 235-315 Magma E-51 21 V
- Teleskop-Rüttler 235-315 Magma E-51 21 V**
- Telescopic harvester 235-315 Magma E-51 21 V



629 1 500,00- 8 016604006296 43

- Abbacchiatore Magma E-35 21 V**
- Vareador Magma E-35 21 V
- Rüttler Magma E-35 21 V**
- Harvester Magma E-35 21 V



624 2 560,00- 8 016604006241 43

- Motosega Magma E-200 LA 21 V**
- Motosierra Magma E-200 LA 21 V
- Motorsäge Magma E-200 LA 21 V**
- Chainsaw Magma E-200 LA 21 V



618 2 270,00- 8 016604006180 44

- Motosega Magma E-150 LA 21 V**
- Motosierra Magma E-150 LA 21 V
- Motorsäge Magma E-150 LA 21 V**
- Chainsaw Magma E-150 LA 21 V



619 2 234,00- 8 016604006197 44

- Motosega Magma E-150 LM 21 V**
- Motosierra Magma E-150 LM 21 V
- Motorsäge Magma E-150 LM 21 V**
- Chainsaw Magma E-150 LM 21 V



617 2 196,00- 8 016604006173 45

- Motosega Magma E-100 LM 21 V**
- Motosierra Magma E-100 LM 21 V
- Motorsäge Magma E-100 LM 21 V**
- Chainsaw Magma E-100 LM 21 V



616 2 166,00- 8 016604006166 45

- Motosega telescopica Magma E-300 LA 21 V**
- Motosierra telescópica Magma E-300 LA 21 V
- Teleskop-Motorsäge Magma E-300 LA 21 V**
- Telescopic chainsaw Magma E-300 LA 21 V



615 1 448,00- 8 016604006159 46

INDICE ATREZZI 21 V

ÍNDICE DE HERRAMIENTAS 21 V
INHALTSVERZEICHNIS 21 V GERÄTE
21 V TOOLS INDEX

21V POWER
LINE
Stocker

Art.	Pz./St.	€	EAN	
------	---------	---	-----	--

- Forbice telescopica Magma E-35 TR 21 V**
- Tijera telescópica Magma E-35 TR 21 V
- Teleskopschere Magma E-35 TR 21 V**
- Telescopic shears Magma E-35 TR 21 V



614 1 376,00- 8 016604006142 46

- Troncarami Magma E-100/140 TR 21 V**
- Cortarramas Magma E-100/140 TR 21 V
- Astschere Magma E-100/140 TR 21 V**
- Lopper Magma E-100/140 TR 21 V



623 1 342,00- 8 016604006234 47

622 1 337,00- 8 016604006227 47

- Ergomist pompa a zaino elettrica 20 L 21 V**
- Ergomist Bomba de mochila eléctrica 20 L 21 V
- Ergomist Elektrische Rückenspritze 20 L 21 V**
- Ergomist Electric backpack sprayer 20 L 21 V



406 2 222,00- 8 016604004063 48

- Ergomist pompa a zaino elettrica 15 L 21 V**
- Ergomist Bomba de mochila eléctrica 15 L 21 V
- Ergomist Elektrische Rückenspritze 15 L 21 V**
- Ergomist Electric backpack sprayer 15 L 21 V



405 2 207,00- 8 016604004056 48

- Ergomist pompa a zaino elettrica 12 L 21 V**
- Ergomist Bomba de mochila eléctrica 12 L 21 V
- Ergomist Elektrische Rückenspritze 12 L 21 V**
- Ergomist Electric backpack sprayer 12 L 21 V



404 2 199,50- 8 016604004049 49

- Calipso Idropulitrice E-800 2x21 V**
- Calipso Hidrolimpiadora E-800 2x21 V
- Calipso Hochdruckreiniger E-800 2x21 V**
- Calipso Pressure Washer E-800 2x21 V



434 1 176,00- 8 016604004346 50

- Calipso Pistola Idropulitrice E-200 21 V**
- Calipso Pistola Hidrolimpiadora E-200 21 V
- Calipso Hochdruckpistole E-200 21 V**
- Calipso Pressure Washer Gun E-200 21 V



433 4 79,20- 8 016604004339 51

- Faro LED a batteria 21 V**
- Faro a batería LED 21 V
- LED Scheinwerfer Batteriebetrieben 21 V**
- Battery LED light 21 V



626 2 52,30- 8 016604006265 52

- Ventilatore a batteria 21 V**
- Ventilador a batería 21 V
- Ventilator Batteriebetrieben 21 V**
- Battery fan 21 V



625 2 56,40- 8 016604006258 52

- Aspirapolvere e soffiatore a batteria 21 V**
- Aspirador y soplador a batería 21 V
- Staubsauger und Gebläse Batteriebetrieben 21 V**
- Battery vacuum and blower 21 V



627 1 99,70- 8 016604006272 53



stocker

www.stockergarden.com

21 V POWER LINE
stocker



8,0 Ah

Art. 328
54

4,0 Ah

Art. 325
54

2,6 Ah

Art. 312/7
54

PIÙ ESIGENZE, UNA SOLUZIONE

MÚLTIPLES NECESIDADES, UNA SOLUCIÓN
ÜBERZEUGENDE LÖSUNG FÜR VIELE ANWENDUNGEN
MULTIPLE NEEDS, ONE SOLUTION

21 V POWER LINE
stocker

35mm

CHIAMATA DI SERVIZIO

CE

GARANZIA GARANTIA
36
GARANTEE GUARANTEE

GARANZIA GARANTIA
60
GARANTEE GUARANTEE



Batteria non inclusa
Bateria no incluida
Batterie nicht inbegriffen
Battery not included



Forbice Magma E-35 TP 21 V
Eccezionale capacità di taglio, fino a 35 mm.
Motore brushless da 300 W.
2 modalità di funzionamento: progressivo e automatico.
Regolazione dell'apertura della lama personalizzabile.
Compatibile con tutte le batterie della linea POWER 21 V.

Schere Magma E-35 TP 21 V
Aussergewöhnliche Schneidleistung, bis zu 35 mm.
Bürstenloser 300-W-Motor. 2 Betriebsmodi: progressiv und automatisch.
Individuell anpassbare Klingenöffnung.
Mit allen Batterien der Linie POWER 21 V kompatibel.

Pruning shears Magma E-35 TP 21 V
Exceptional cutting capacity, up to 35 mm.
300 W brushless motor. 2 operating modes: progressive and automatic.
Customizable blade opening adjustment.
Compatible with all batteries of the POWER 21 V LINE.



Art.	cm	Gr.	Pz./St.	€	EAN
621	28	670	2	274,00-	8 016604 006210

MAGMA SYSTEM

PROG. AUTO

vedi pag. 288
ver página 288
siehe Seite 288
see on page 288

21 V POWER LINE
stocker



Manico telescopico orientabile Magma
Mango giratorio telescópico Magma
Teleskopstiel Magma mit Kugelgelenk
Magma Telescopic Swivel Handle

Art.	cm	Gr.	Pz./St.	€	EAN
584	155-235	2	1.800	219,00-	8 016604 005848
585	200-310	2	2.200	244,00-	8 016604 005855

MAGMA SYSTEM

BALLHEAD

ALU

CHIAMATA DI SERVIZIO

vedi pag. 289
ver página 289
siehe Seite 289
see on page 289

21 V POWER LINE
stocker



Manico telescopico Magma
Mango telescópico Magma
Teleskopstiel Magma
Magma telescopic handle

Art.	cm	Gr.	Pz./St.	€	EAN
580	145-225	2	1.600	184,00-	8 016604 005800
581	190-310	2	1.900	215,00-	8 016604 005817

MAGMA SYSTEM

ALU

CHIAMATA DI SERVIZIO

vedi pag. 289
ver página 289
siehe Seite 289
see on page 289

21 V POWER LINE
stocker

120 kg/h

CHIAMATA DI SERVIZIO

CE

GARANZIA GARANTIA
36
GARANTEE GUARANTEE

GARANZIA GARANTIA
60
GARANTEE GUARANTEE



★ NEW



Non inclusi
No incluidos
Nicht inbegriffen
Not included

Abbacchiatore telescopico 235-315 Magma E-51 21 V
Il movimento a ventaglio e la vibrazione delle astine sono progettati per preservare la vegetazione e non disperdere il raccolto. Campo di lavoro di 51 cm. 2 livelli di potenza, 1.050 rpm e 1.200 rpm, per raccogliere fino a 120 kg/h di olive. Motore brushless da 400 W. Compatibile con tutte le batterie della linea POWER 21 V.

Teleskop-Rüttler 235-315 Magma E-51 21 V
Die Fächerbewegung und die Vibration der Karbonstäbe sind so konzipiert, dass die Pflanze geschont und das Erntegut nicht verstreut wird. Arbeitsbreite von 51 cm. 2 Arbeitsgeschwindigkeiten: 1050 U/min und 1200 U/min für eine Ernte von bis zu 120 kg Oliven pro Stunde. Bürstenloser 400-W-Motor. Es ist mit allen POWER 21V-Batterien kompatibel.

Vareador telescópico 235-315 Magma E-51 21 V
El movimiento en abanico y la vibración de las varillas están diseñados para preservar la vegetación y no dispersar la cosecha. Rango de trabajo de 51 cm. 2 velocidades de trabajo: 1050 rpm y 1200 rpm para recolectar hasta 120 kg/h de aceitunas. Motor brushless de 400 W. Compatible con todas las baterías de la línea POWER 21 V.

Telescopic harvester 235-315 Magma E-51 21 V
The fan-shaped movement and vibration of the rods are designed to preserve the vegetation and to avoid dispersal of the crop. Working range 51 cm. 2 working speeds: 1050 rpm and 1200 rpm to collect up to 120 kg/h of olives. 400 W brushless motor. Compatible with all batteries of the POWER 21 V LINE.



MAGMA SYSTEM

51 cm

vedi pag. 290
ver página 290
siehe Seite 290
see on page 290

Art.	cm	Gr.	Pz./St.	€	EAN
629	235-315	3.140	1	500,00-	8 016604 006296

21 V POWER LINE
stocker

120 kg/h

CHIAMATA DI SERVIZIO

CE

GARANZIA GARANTIA
36
GARANTEE GUARANTEE

GARANZIA GARANTIA
60
GARANTEE GUARANTEE



Batteria non inclusa
Bateria no incluida
Batterie nicht inbegriffen
Battery not included



Vareador Magma E-35 21 V
Rango de trabajo de 35 cm y 1.350 rpm para recolectar hasta 120 kg/h de aceitunas. Rotación cónica hacia el interior para no dispersar la cosecha. Motor de escobillas de 205 W. Modo de funcionamiento: automático. Compatible con todas las baterías de la línea POWER 21 V.

Rüttler Magma E-35 21 V
Arbeitsbreite von 35 cm und 1.350 rpm für eine Ernte von bis zu 120 kg Oliven pro Stunde. Konische Rotationsrichtung nach Innen, um die Ernte nicht zu zerstreuen. 205-W-Bürstenmotor. Betriebsmodus: automatisch. Mit allen Batterien der Linie POWER 21 V kompatibel.

Abbacchiatore Magma E-35 21 V
Campo di lavoro di 35 cm e 1.350 rpm per raccogliere fino a 120 kg/h di olive. Rotazione conica verso l'interno per non disperdere il raccolto. Motore a spazzole da 205 W. Modalità di funzionamento: automatica. Compatibile con tutte le batterie della linea POWER 21 V.

Harvester Magma E-35 21 V
Working range of 35 cm and 1.350 rpm to collect up to 120 kg/h of olives. Inward conical rotation to avoid dispersal of the crop. 205 W brush motor. Operating mode: automatic. Compatible with all batteries of the POWER 21 V LINE.



MAGMA SYSTEM

35 cm

vedi pag. 291
ver página 291
siehe Seite 291
see on page 291

Art.	cm	Gr.	Pz./St.	€	EAN
624	55	845	2	560,00-	8 016604 006241

21 V POWER LINE

stocker



Batteria non inclusa
Bateria no incluida
Batterie nicht inbegriffen
Battery not included



Motosega Magma E-200 LA 21 V

Il cambio catena è facilitato da un sistema semplice e veloce. Lubrificazione catena automatica. Motore brushless da 450 W per una lunga durata. Avviamenti accidentali sono evitati dal tasto di sicurezza. Arpione aiuta a guidare il taglio. Velocità di taglio: 12 m/s. 60-65 tagli con diametro medio di 10 cm con una batteria STOCKER POWER 21 V 4 Ah. Compatibile con tutte le batterie della linea POWER 21 V. Carica batterie doppio in dotazione. Kit di manutenzione incluso.

Motosierra Magma E-200 LA 21 V

El cambio de cadena se facilita mediante un sistema sencillo y rápido. Lubricación automática de la cadena. Motor brushless de 450 W para una larga duración. Arranques accidentales se evitan mediante el botón de seguridad. El arpón ayuda a guiar el corte. Velocidad de corte: 12 m/s. 60-65 cortes con un diámetro medio de 10 cm con una batería STOCKER POWER 21 V 4 Ah. Compatible con todas las baterías de la línea POWER 21 V. Cargador doble en dotación. Kit de mantenimiento incluido.

Motorsäge Magma E-200 LA 21 V

Vereinfachtes System für den Wechsel der Kette. Automatische Schmierung der Kette. Bürstenloser 450-W-Motor für eine lange Lebensdauer. Sicherheitstaste verhindert unbeabsichtigtes Auslösen. Krallenanschlag für einen sauberen Schnitt. Schnittgeschwindigkeit: 12 m/s. 60-65 Schnitte bei einem Durchmesser von 10 cm mit einer STOCKER POWER 21 V 4 Ah Batterie durchgeführt. Mit allen Batterien der Linie POWER 21 V kompatibel. Wartungs-Kit und Doppelladegerät inbegriffen.

Chainsaw Magma E-200 LA 21 V

Easy chain substitution thanks to an easy and fast system. Automatic chain lubrication. 450 W brushless motor, for a long lasting product. Accidental starts are prevented by the safety button. Harpoon helps guide the cut. Cutting speed 12m/s. 60-65 cuts with a 10 cm average diameter with one STOCKER POWER 21 V 4 Ah battery. Compatible with all batteries of the POWER 21 V LINE. Double battery charger included. A maintenance kit is included.



vedi pag. 292
ver página 292
siehe Seite 292
see on page 292

Art.	cm	Gr.	Pz./St.	€	EAN
618	52	1.520	2	270,00-	8 016604 006180

21 V POWER LINE

stocker



Batteria non inclusa
Bateria no incluida
Batterie nicht inbegriffen
Battery not included



Motosega Magma E-150 LM 21 V

Il cambio catena è facilitato da un sistema semplice e veloce. Lubrifica quando serve. Motore brushless da 350 W per una lunga durata. Avviamenti accidentali sono evitati dal tasto di sicurezza. Arpione aiuta a guidare il taglio. Velocità di taglio: 12 m/s. 60-65 tagli con diametro medio di 8 cm con una batteria STOCKER POWER 21 V 4 Ah. Compatibile con tutte le batterie della linea POWER 21 V. Carica batterie doppio in dotazione. Kit di manutenzione incluso.

Motosierra Magma E-150 LM 21 V

El cambio de cadena se facilita mediante un sistema sencillo y rápido. El cambio de cadena se facilita mediante un sistema sencillo y rápido. Lubrica cuando es necesario. Motor brushless de 350 W para una larga duración. Arranques accidentales se evitan mediante el botón de seguridad. El arpón ayuda a guiar el corte. Velocidad de corte: 12 m/s. 60-65 cortes con un diámetro medio de 8 cm con una batería STOCKER POWER 21 V 4 Ah. Compatible con todas las baterías de la línea POWER 21 V. Cargador doble en dotación. Kit de mantenimiento incluido.

Motorsäge Magma E-150 LM 21 V

Vereinfachtes System für den Wechsel der Kette. Individuelles schmieren. Bürstenloser 350-W-Motor für eine lange Lebensdauer. Sicherheitstaste verhindert unbeabsichtigtes Auslösen. Krallenanschlag für einen sauberen Schnitt. Schnittgeschwindigkeit: 12 m/s. 60-65 Schnitte bei einem Durchmesser von 8 cm mit einer STOCKER POWER 21 V 4 Ah Batterie durchgeführt. Mit allen Batterien der Linie POWER 21 V kompatibel. Wartungs-Kit und Doppelladegerät inbegriffen.

Chainsaw Magma E-150 LM 21 V

Easy chain substitution thanks to an easy and fast system. Lubricate when needed. 350 W brushless motor, for a long lasting product. Accidental starts are prevented by the safety button. Harpoon helps guide the cut. Cutting speed 12m/s. 60-65 cuts with a 8 cm average diameter with one STOCKER POWER 21 V 4 Ah battery. Compatible with all batteries of the POWER 21 V LINE. Double battery charger included. A maintenance kit is included.



vedi pag. 294
ver página 294
siehe Seite 294
see on page 294

Art.	cm	Gr.	Pz./St.	€	EAN
617	47	1.320	2	196,00-	8 016604 006173

21 V POWER LINE

stocker



Batteria non inclusa
Bateria no incluida
Batterie nicht inbegriffen
Battery not included



Motosega Magma E-150 LA 21 V

Il cambio catena è facilitato da un sistema semplice e veloce. Lubrificazione catena automatica. Motore brushless da 400 W per una lunga durata. Avviamenti accidentali sono evitati dal tasto di sicurezza. Arpione aiuta a guidare il taglio. Velocità di taglio: 12 m/s. 60-65 tagli con diametro medio di 8 cm con una batteria STOCKER POWER 21 V 4 Ah. Compatibile con tutte le batterie della linea POWER 21 V. Carica batterie doppio in dotazione. Kit di manutenzione incluso.

Motosierra Magma E-150 LA 21 V

El cambio de cadena se facilita mediante un sistema sencillo y rápido. Lubricación automática de la cadena. Motor brushless de 400 W para una larga duración. Arranques accidentales se evitan mediante el botón de seguridad. El arpón ayuda a guiar el corte. Velocidad de corte: 12 m/s. 60-65 cortes con un diámetro medio de 8 cm con una batería STOCKER POWER 21 V 4 Ah. Compatible con todas las baterías de la línea POWER 21 V. Cargador doble en dotación. Kit de mantenimiento incluido.

Motorsäge Magma E-150 LA 21 V

Vereinfachtes System für den Wechsel der Kette. Automatische Schmierung der Kette. Bürstenloser 400-W-Motor für eine lange Lebensdauer. Sicherheitstaste verhindert unbeabsichtigtes Auslösen. Krallenanschlag für einen sauberen Schnitt. Schnittgeschwindigkeit: 12 m/s. 60-65 Schnitte bei einem Durchmesser von 8 cm mit einer STOCKER POWER 21 V 4 Ah Batterie durchgeführt. Mit allen Batterien der Linie POWER 21 V kompatibel. Wartungs-Kit und Doppelladegerät inbegriffen.

Chainsaw Magma E-150 LA 21 V

Easy chain substitution thanks to an easy and fast system. Automatic chain lubrication. 400 W brushless motor, for a long lasting product. Accidental starts are prevented by the safety button. Harpoon helps guide the cut. Cutting speed 12m/s. 60-65 cuts with a 8 cm average diameter with one STOCKER POWER 21 V 4 Ah battery. Compatible with all batteries of the POWER 21 V LINE. Double battery charger included. A maintenance kit is included.



vedi pag. 293
ver página 293
siehe Seite 293
see on page 293

Art.	cm	Gr.	Pz./St.	€	EAN
619	47	1.280	2	234,00-	8 016604 006197

21 V POWER LINE

stocker



Batteria non inclusa
Bateria no incluida
Batterie nicht inbegriffen
Battery not included



Motosega Magma E-100 LM 21 V

Il cambio catena è facilitato da un sistema semplice e veloce. Lubrifica quando serve. Motore brushless da 350 W per una lunga durata. Avviamenti accidentali sono evitati dal tasto di sicurezza. Arpione aiuta a guidare il taglio. Velocità di taglio: 12 m/s. 60-65 tagli con diametro medio di 6 cm con una batteria STOCKER POWER 21 V 4 Ah. Compatibile con tutte le batterie della linea POWER 21 V. Carica batterie doppio in dotazione. Kit di manutenzione incluso.

Motosierra Magma E-100 LM 21 V

El cambio de cadena se facilita mediante un sistema sencillo y rápido. Lubrica cuando es necesario. Motor brushless de 350 W para una larga duración. Arranques accidentales se evitan mediante el botón de seguridad. El arpón ayuda a guiar el corte. Velocidad de corte: 12 m/s. 60-65 cortes con un diámetro medio de 6 cm con una batería STOCKER POWER 21 V 4 Ah. Compatible con todas las baterías de la línea POWER 21 V. Cargador doble en dotación. Kit de mantenimiento incluido.

Motorsäge Magma E-100 LM 21 V

Vereinfachtes System für den Wechsel der Kette. Individuelles schmieren. Bürstenloser 350-W-Motor für eine lange Lebensdauer. Sicherheitstaste verhindert unbeabsichtigtes Auslösen. Krallenanschlag für einen sauberen Schnitt. Schnittgeschwindigkeit: 12 m/s. 60-65 Schnitte bei einem Durchmesser von 6 cm mit einer STOCKER POWER 21 V 4 Ah Batterie durchgeführt. Mit allen Batterien der Linie POWER 21 V kompatibel. Wartungs-Kit und Doppelladegerät inbegriffen.

Chainsaw Magma E-100 LM 21 V

Easy chain substitution thanks to an easy and fast system. Lubricate when needed. 350 W brushless motor, for a long lasting product. Accidental starts are prevented by the safety button. Harpoon helps guide the cut. Cutting speed 12m/s. 60-65 cuts with a 6 cm average diameter with one STOCKER POWER 21 V 4 Ah battery. Compatible with all batteries of the POWER 21 V LINE. Double battery charger included. A maintenance kit is included.



vedi pag. 294
ver página 294
siehe Seite 294
see on page 294

Art.	cm	Gr.	Pz./St.	€	EAN
616	42	1.270	2	166,00-	8 016604 006166

21 V POWER LINE
stocker

230mm 55° CHIAMATA DI SERVIZIO CE

GARANZIA GARANTIA 36 MESI GARANTIE GARANTIE
GARANZIA GARANTIA 60 MESI GARANTIE GARANTIE



Batteria non inclusa
Bateria no incluida
Batterie nicht inbegriffen
Battery not included

de 10 cm con una batería STOCKER POWER 21 V 8,0 Ah. Compatible con todas las baterías de la línea POWER 21 V.

Teleskop-Motorsäge Magma E-300 LA 21 V
Bis zu 55° neigbarer Schneidkopf für optimale Sichtverhältnisse beim Schneiden. Vereinfachtes System für den Wechsel der Kette. Automatische Schmierung der Kette. Bürstenloser 800-W-Motor für eine lange Lebensdauer. Sicherheitstaste verhindert unbeabsichtigtes Auslösen. Mit praktischem Haken für das Entfernen vom Schnittgut. Schnittgeschwindigkeit: 16m/s. 110-120 Schnitte bei einem Durchmesser von 10 cm mit einer STOCKER POWER 21 V 8 Ah Batterie durchgeführt. Mit allen Batterien der Linie POWER 21 V kompatibel.

Telescopic chainsaw Magma E-300 LA 21 V
The 55° vertically adjustable head offers a wide view of the cut. Easy chain substitution thanks to an easy and fast system. Automatic chain lubrication. 800 W brushless motor, for a long lasting product. Accidental starts are prevented by the safety button. Iron hook facilitates the removal of cut branches. Cutting speed 16m/s. 110-120 cuts with a 10 cm average diameter with one STOCKER POWER 21 V 8 Ah battery. Compatible with all batteries of the POWER 21 V LINE.



Art.	cm	Gr.	Pz./St.	€	EAN
615	215-305	2.990	1	448,00-	8 016604 006159

MAGMA SYSTEM 10" 29,5 cm 1,1 mm 1/4" 16 m/s 215-305 cm

vedi pag. 295
ver página 295
siehe Seite 295
see on page 295

21 V POWER LINE
stocker

35mm CHIAMATA DI SERVIZIO CE

GARANZIA GARANTIA 36 MESI GARANTIE GARANTIE
GARANZIA GARANTIA 60 MESI GARANTIE GARANTIE



Batteria non inclusa
Bateria no incluida
Batterie nicht inbegriffen
Battery not included

Teleskopschere Magma E-35 TR 21 V
Die Länge bis 320 cm erleichtert das Entasten vom Boden bis zu einer Höhe von circa 4,5 m. Außergewöhnlicher Schnittdurchmesser von bis zu 35 mm und mehr Leistung dank bürstenlosem 300-W-Motor. Batteriestatus durch LED-Kontrollanzeige immer im Blick. Mit allen Batterien der Linie POWER 21 V kompatibel.

Telescopic shears Magma E-35 TR 21 V
Slender cutting head for easy insertion between branches. Length up to 320 cm facilitates the cutting of branches up to a height of 4,5 m. Exceptional cutting capacity, up to 35 mm. 300 W brushless motor. Charge status indicator with 4 LEDs. Compatible with all batteries of the POWER 21 V LINE.



Art.	cm	Gr.	Pz./St.	€	EAN
614	210-320	2.500	1	376,00-	8 016604 006142

MAGMA SYSTEM 210-320 cm

vedi pag. 296
ver página 296
siehe Seite 296
see on page 296

21 V POWER LINE
stocker

35mm CHIAMATA DI SERVIZIO CE

GARANZIA GARANTIA 36 MESI GARANTIE GARANTIE
GARANZIA GARANTIA 60 MESI GARANTIE GARANTIE



Batteria non inclusa
Bateria no incluida
Batterie nicht inbegriffen
Battery not included

Astschere Magma E-140 TR 21 V
Die Länge von 140 cm erleichtert das Entasten vom Boden bis zu einer Höhe von circa 3 m. Außergewöhnlicher Schnittdurchmesser von bis zu 35 mm und mehr Leistung dank bürstenlosem 300-W-Motor. Batteriestatus durch LED-Kontrollanzeige immer im Blick. Mit allen Batterien der Linie POWER 21 V kompatibel.

Lopper Magma E-140 TR 21 V
Slender cutting head for easy insertion between branches. Length of 140 cm facilitates the cutting of branches up to a height of 3 m. Exceptional cutting capacity, up to 35 mm. 300 W brushless motor. Charge status indicator with 4 LEDs. Compatible with all batteries of the POWER 21 V LINE.



Art.	cm	Gr.	Pz./St.	€	EAN
623	140	1.620	1	342,00-	8 016604 006234

MAGMA SYSTEM 140 cm

vedi pag. 297
ver página 297
siehe Seite 297
see on page 297

21 V POWER LINE
stocker

35mm CHIAMATA DI SERVIZIO CE

GARANZIA GARANTIA 36 MESI GARANTIE GARANTIE
GARANZIA GARANTIA 60 MESI GARANTIE GARANTIE



Batteria non inclusa
Bateria no incluida
Batterie nicht inbegriffen
Battery not included

Troncarami Magma E-100 TR 21 V
Testa di taglio snella per infilarsi agevolmente tra i rami. Lunghezza di 100 cm agevola il taglio di rami fino ad una altezza di 2,5 m. Eccezionale capacità di taglio, fino a 35 mm. Motore brushless da 300 W. Indicatore dello stato di carica con 4 LED. Compatibile con tutte le batterie della linea POWER 21 V.

Cortarramas Magma E-100 TR 21 V
Cabezal de corte delgado para facilitar la inserción entre las ramas. La longitud de 100 cm facilita el corte de ramas hasta una altura de 2,5 m. Excepcional capacidad de corte, hasta 35 mm. Motor brushless de 300 W. Indicador de estado de carga con 4 LEDs. Compatible con todas las baterías de la línea POWER 21 V.



Art.	cm	Gr.	Pz./St.	€	EAN
622	100	1.470	1	337,00-	8 016604 006227

MAGMA SYSTEM 100 cm

vedi pag. 297
ver página 297
siehe Seite 297
see on page 297

Astschere Magma E-100 TR 21 V
Die Länge von 100 cm erleichtert das Entasten vom Boden bis zu einer Höhe von circa 2,5 m. Außergewöhnlicher Schnittdurchmesser von bis zu 35 mm und mehr Leistung dank bürstenlosem 300-W-Motor. Batteriestatus durch LED-Kontrollanzeige immer im Blick. Mit allen Batterien der Linie POWER 21 V kompatibel.

Lopper Magma E-100 TR 21 V
Slender cutting head for easy insertion between branches. Length of 100 cm facilitates the cutting of branches up to a height of 2,5 m. Exceptional cutting capacity, up to 35 mm. 300 W brushless motor. Charge status indicator with 4 LEDs. Compatible with all batteries of the POWER 21 V LINE.

Art.	cm	Gr.	Pz./St.	€	EAN
622	100	1.470	1	337,00-	8 016604 006227

21 V POWER LINE

2,5/5 BAR



2x

FIBRE GLASS

ALU

Stocker



Ergomist pompa a zaino elettrica 20 L 21 V

Nuovo sistema a zaino ergonomico per una migliore distribuzione del carico e nuova robusta impugnatura. Ugello interno per miscelazione ottimale del prodotto (0,8 bar). Pressione regolabile su due livelli: 2,5 o 5 bar. Indicatore dello stato di carica con 3 LED. Lancia in alluminio, lancia in fibra di vetro e caricabatterie doppio in dotazione. Compatibile con tutte le batterie della linea POWER 21 V.

Ergomist Bomba de mochila eléctrica 20 L 21 V

Innovador sistema de mochila ergonómica para una mejor distribución de la carga y nueva empuñadura robusta. Boquilla interna para una mezcla óptima del producto (0,8 bar). Presión ajustable a dos niveles: 2,5 o 5 bar. Indicador de estado de carga con 3 LEDs. Lanza en fibra de vidrio, lanza de aluminio y cargador doble en dotación. Compatible con todas las baterías de la línea POWER 21 V.

Ergomist Elektrische Rückenspritze 20 L 21 V

Innovatives, ergonomisches Rucksacksystem für eine bessere Gewichtsverteilung und neuen robusten Griff. Interne Mischdüse für eine optimale Mischung der Flüssigkeit (0,8 bar). Zwei Arbeitsstufen von 2,5 oder 5 Bar. Batteriestatus durch LED-Kontrollanzeige immer im Blick. Komplett mit Handbrause aus Aluminium, Handbrause aus Fiberglas und Doppelladegerät. Mit allen Batterien der Linie POWER 21 V kompatibel.

Ergomist Electric backpack sprayer 20 L 21 V

New ergonomic backpack system for an optimal distribution of the weight and new handle shape. Internal nozzle allows optimal mixing of any product (0,8 bar). Two levels of adjustable pressure: 2,5 and 5 bar. Charge status indicator with 3 LEDs. Complete with aluminium spray lance, fiberglass spray lance and double battery charger. Compatible with all batteries of the POWER 21 V LINE.



Batteria non inclusa
Bateria no incluida
Batterie nicht inbegriffen
Battery not included



Art.	lt.	Gr.	Pz./St.	€	EAN
406	20	3.950	2	222,00-	8 016604 004063

vedi pag. 298
ver página 298
siehe Seite 298
see on page 298

21 V POWER LINE

2,5/5 BAR



2x

FIBRE GLASS

ALU

Stocker



Ergomist pompa a zaino elettrica 15 L 21 V

Nuovo sistema a zaino ergonomico per una migliore distribuzione del carico e nuova robusta impugnatura. Ugello interno per miscelazione ottimale del prodotto (0,8 bar). Pressione regolabile su due livelli: 2,5 o 5 bar. Indicatore dello stato di carica con 3 LED. Lancia in alluminio, lancia in fibra di vetro e caricabatterie doppio in dotazione. Compatibile con tutte le batterie della linea POWER 21 V.

Ergomist Bomba de mochila eléctrica 15 L 21 V

Innovador sistema de mochila ergonómica para una mejor distribución de la carga y nueva empuñadura robusta. Boquilla interna para una mezcla óptima del producto (0,8 bar). Presión ajustable a dos niveles: 2,5 o 5 bar. Indicador de estado de carga con 3 LEDs. Lanza en fibra de vidrio, lanza de aluminio y cargador doble en dotación. Compatible con todas las baterías de la línea POWER 21 V.

Ergomist Elektrische Rückenspritze 15 L 21 V

Innovatives, ergonomisches Rucksacksystem für eine bessere Gewichtsverteilung und neuen robusten Griff. Interne Mischdüse für eine optimale Mischung der Flüssigkeit (0,8 bar). Zwei Arbeitsstufen von 2,5 oder 5 Bar. Batteriestatus durch LED-Kontrollanzeige immer im Blick. Komplett mit Handbrause aus Aluminium, Handbrause aus Fiberglas und Doppelladegerät. Mit allen Batterien der Linie POWER 21 V kompatibel.

Ergomist Electric backpack sprayer 15 L 21 V

New ergonomic backpack system for an optimal distribution of the weight and new handle shape. Internal nozzle allows optimal mixing of any product (0,8 bar). Two levels of adjustable pressure: 2,5 and 5 bar. Charge status indicator with 3 LEDs. Complete with aluminium spray lance, fiberglass spray lance and double battery charger. Compatible with all batteries of the POWER 21 V LINE.



Batteria non inclusa
Bateria no incluida
Batterie nicht inbegriffen
Battery not included



Art.	lt.	Gr.	Pz./St.	€	EAN
405	15	3.800	2	207,00-	8 016604 004056

vedi pag. 298
ver página 298
siehe Seite 298
see on page 298

21 V POWER LINE

2,5/5 BAR



2x

FIBRE GLASS

ALU

Stocker



Ergomist pompa a zaino elettrica 12 L 21 V

Nuovo sistema a zaino ergonomico per una migliore distribuzione del carico e nuova robusta impugnatura. Ugello interno per miscelazione ottimale del prodotto (0,8 bar). Pressione regolabile su due livelli: 2,5 o 5 bar. Indicatore dello stato di carica con 3 LED. Lancia in alluminio, lancia in fibra di vetro e caricabatterie doppio in dotazione. Compatibile con tutte le batterie della linea POWER 21 V.

Ergomist Bomba de mochila eléctrica 12 L 21 V

Innovador sistema de mochila ergonómica para una mejor distribución de la carga y nueva empuñadura robusta. Boquilla interna para una mezcla óptima del producto (0,8 bar). Presión ajustable a dos niveles: 2,5 o 5 bar. Indicador de estado de carga con 3 LEDs. Lanza en fibra de vidrio, lanza de aluminio y cargador doble en dotación. Compatible con todas las baterías de la línea POWER 21 V.

Ergomist Elektrische Rückenspritze 12 L 21 V

Innovatives, ergonomisches Rucksacksystem für eine bessere Gewichtsverteilung und neuen robusten Griff. Interne Mischdüse für eine optimale Mischung der Flüssigkeit (0,8 bar). Zwei Arbeitsstufen von 2,5 oder 5 Bar. Batteriestatus durch LED-Kontrollanzeige immer im Blick. Komplett mit Handbrause aus Aluminium, Handbrause aus Fiberglas und Doppelladegerät. Mit allen Batterien der Linie POWER 21 V kompatibel.

Ergomist Electric backpack sprayer 12 L 21 V

New ergonomic backpack system for an optimal distribution of the weight and new handle shape. Internal nozzle allows optimal mixing of any product (0,8 bar). Two levels of adjustable pressure: 2,5 and 5 bar. Charge status indicator with 3 LEDs. Complete with aluminium spray lance, fiberglass spray lance and double battery charger. Compatible with all batteries of the POWER 21 V LINE.



Batteria non inclusa
Bateria no incluida
Batterie nicht inbegriffen
Battery not included



Art.	lt.	Gr.	Pz./St.	€	EAN
404	12	3.500	2	199,50-	8 016604 004049

vedi pag. 298
ver página 298
siehe Seite 298
see on page 298



21 V POWER LINE

Stocker

2x 21 V POWER LINE

35/50/70 BAR



CE



2x 21 V POWER LINE

NEW



Non inclusi
No incluidos
Nicht inbegriffen
Not included

Calipso Idropulitrice E-800 2x21 V
Ugello regolabile: getto diretto e a ventaglio. Con tubo alta pressione 10 m. 3 livelli di potenza. Motore brushless. Potenza nominale: 800 W. Funziona con 2 batterie della linea POWER 21 V. Compatibile con tutte le batterie della linea POWER 21 V.

Calipso Hidrolimpiadora E-800 2x21 V
Boquilla regulable: chorro directo y de abanico. Con manguera de alta presión de 10 m. 3 niveles de potencia. Motor sin escobillas. Potencia nominal: 800 W. Funciona con 2 baterías de la línea POWER 21 V. Compatible con todas las baterías de la línea POWER 21 V.

Calipso Hochdruckreiniger E-800 2x21 V
Einstellbare Düse: Stech- und Fächerstrahl. Mit Hochdruckschlauch 10 m. Drei Leistungsstufen. Bürstenloser Motor. Nennleistung: 800 W. Betrieb mit 2 POWER LINE 21 V Batterien. Mit allen Batterien der Linie POWER 21 V kompatibel.

Calipso Pressure Washer E-800 2x21 V
Adjustable nozzle: direct and fan spray. With 10 m high pressure hose. 3 power levels. Brushless motor. Rated power: 800 W. It works with 2 POWER 21 V batteries. Compatible with all batteries of the POWER 21 V LINE.



vedi pag. 299
ver página 299
siehe Seite 299
see on page 299



Art.	cm	Gr.	Pz./St.	€	EAN
434	33 x 28 x h 27	3.680	1	176,00-	8 016604 004346

21 V POWER LINE

Stocker

35 BAR



CE



NEW



Non inclusi
No incluidos
Nicht inbegriffen
Not included

Calipso Pistola Idropulitrice E-200 21 V
Ugello regolabile: getto diretto e a ventaglio. Flessibilità: aspira l'acqua con il tubo da 5 m con filtro o si collega alla rete idrica fissa. Motore a spazzole. Potenza nominale: 200 W. Compatibile con tutte le batterie della linea POWER 21 V.

Calipso Pistola Hidrolimpiadora E-200 21 V
Boquilla regulable: chorro directo y de abanico. Flexibilidad: aspira agua con la manguera con filtro de 5 m o se conecta al suministro de agua fijo. Motor de escobillas. Potencia nominal: 200 W. Compatible con todas las baterías de la línea POWER 21 V.

Calipso Hochdruckpistole E-200 21 V
Einstellbare Düse: Stech- und Fächerstrahl. Flexibilität: Ansaugen durch 5-m-Schlauch oder mit dem Gartenschlauch. Bürstenmotor. Nennleistung: 200 W. Mit allen Batterien der Linie POWER 21 V kompatibel.

Calipso Pressure Washer Gun E-200 21 V
Adjustable nozzle: direct and fan spray. Flexibility: vacuum water with the 5 m hose with filter or it connects to the fixed water supply. Brush motor. Rated power: 200 W. Compatible with all batteries of the POWER 21 V LINE.



vedi pag. 300
ver página 300
siehe Seite 300
see on page 300



Art.	cm	Gr.	Pz./St.	€	EAN
433	87	1.450	4	79,20-	8 016604 004339

Spazzola rotativa
La parte interna della spazzola ruota per rimuovere meglio lo sporco. Pulisce tutte le superfici lisce, verniciate, in vetro o in plastica. Compatibile con le idropultrici Stocker.

Cepillo rotativo
El interior del cepillo gira para eliminar mejor la suciedad. Para limpiar todas las superficies lisas, pintadas, de vidrio o plásticas. Compatible con las hidrolimpiadoras Stocker.

Rotierende Reinigungsbürste
Die Innenseite der Bürste rotiert, um den Schmutz besser zu entfernen. Für die Reinigung von verschiedensten Oberflächen. Kompatibel mit Stocker-Hochdruckreinigern.

Rotary brush
The inside of the brush rotates to better remove dirt. For cleaning all smooth, painted, glass or plastic surfaces. Compatible with Stocker high pressure cleaners.



smooth, painted, glass or plastic surfaces. Compatible with Stocker high pressure cleaners.



Art.	cm	Gr.	Pz./St.	€	EAN
435	43 x 16 x h 10	380	10	12,15-	8 016604 004353

Sapone per lavaggio auto 3 in 1 da 1 L
Per lavaggio automobili. Formulazione 3 in 1: sgrassante, detergente e lucidante. Applicazione ideale con Art. 307, vedi pag. 126 - Pompa a pressione con ugello per schiuma.

Jabón 3 en 1 para el lavado de coches 1 L
Para lavado de coches. Formulación 3 en 1: desengrasante, limpiador y abrillantador. Aplicación ideal con art. 307, ver página 126 - Bomba de presión con boquilla de espuma.

Autoshampoo 3in1 - 1 L
Für die Autowäsche. 3-in-1-Formulierung: Fettlöser, Reiniger und Politur. Ideale Anwendung mit Art. 307. siehe Seite 126 - Druckpumpe mit Schaumdüse.

3-in-1 car wash soap 1 L
For automotive washing. 3-in-1 formulation: degreasing, cleaning and polishing agent. Ideal application with item 307, see on page 126 - Pressure pump with foam nozzle.



and polishing agent. Ideal application with item 307, see on page 126 - Pressure pump with foam nozzle.



Art.	ml	Pz./St.	€	EAN
45152	1000	6	10,15-	8 016604 451522

Tubo aspirazione 5 m con filtro e raccordo rapido
Con filtro antispurco per aspirare l'acqua da secchi, bacinelle, barili. Compatibile con le idropultrici Stocker art. 433 e art. 434.

Manguera de aspiración de 5 m con filtro y conector rápido
Con filtro antisuciedad para aspirar agua de baldes, palanganas, barriles. Compatible con las hidrolimpiadoras Stocker art. 433 y art. 434.

Hochdruckschlauch 5 m mit Filter und Schnellanschluss
Mit Filter zum Absaugen von Flüssigkeiten aus unreinen Behältnissen. Kompatibel mit Stocker-Hochdruckreinigern art. 433 und art. 434.

5 m vacuum hose with filter and quick hose connector
With anti-dirt filter to vacuum water from buckets, bowls, barrels. Compatible with Stocker high pressure cleaners item 433 and item 434.

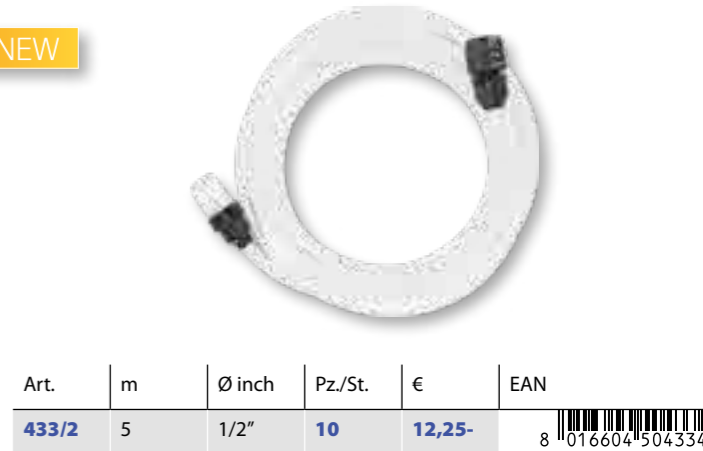

Art.	m	Ø inch	Pz./St.	€	EAN
433/2	5	1/2"	10	12,25-	8 016604 504334

Tubo alta pressione 10 m
Compatibile con idropultrice Stocker art. 434.

Manguera de alta presión de 10 m
Compatible con hidrolimpiadora Stocker art. 434.

Hochdruckschlauch 10 m
Kompatibel mit Stocker-Hochdruckreiniger art. 434.

10 m high pressure hose
Compatible with Stocker pressure washer item 434.

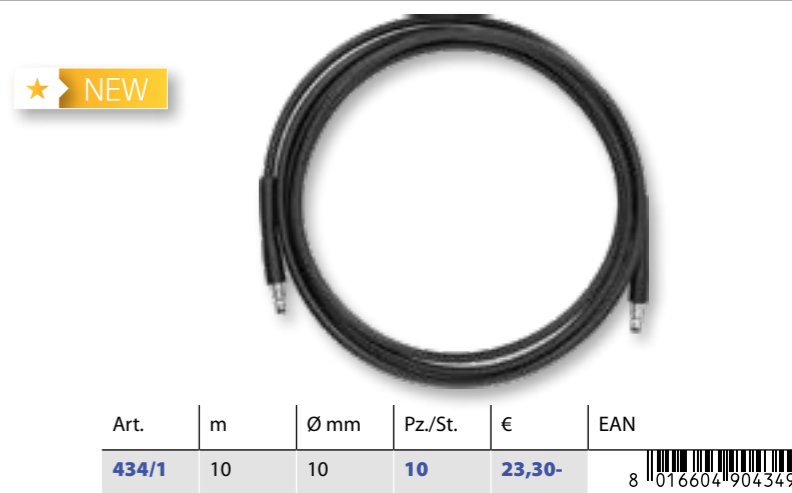

Art.	m	Ø mm	Pz./St.	€	EAN
434/1	10	10	10	23,30-	8 016604 904349

★ NEW



PRODOTTO TOP
 38

Non inclusi
 No incluidos
 Nicht inbegriffen
 Not included

Faro LED a batteria 21 V
 Tre regolazioni di intensità (2700 - 2000 - 1100 Lumen).
 Luce bianca (6500 K).
 Potenza nominale: 30 W.
 Inclinabile fino a 360°.
 Compatibile con tutte le batterie della linea POWER 21 V.

Faro a batería LED 21 V
 Tres ajustes de intensidad (2700 - 2000 - 1100 Lumen).
 Luz blanca (6500 K).
 Potencia nominal: 30 W.
 Se inclina hasta 360°.
 Compatible con todas las baterías de la línea POWER 21 V.

LED Scheinwerfer Batteriebetrieben 21 V
 Drei Einstellungen (2700 - 2000 - 1100 Lumen).
 Weißes Licht (6500 K).
 Nennleistung: 30 W.
 Neigt sich bis zu 360°.
 Mit allen Batterien der Linie POWER 21 V kompatibel.

Battery LED light 21 V
 Three beam intensity settings (2700 - 2000 - 1100 Lumen).
 White light (6500 K).
 Rated power: 30 W.
 Tilts up to 360°.
 Compatible with all batteries of the POWER 21 V LINE.



Art.	cm	Gr.	Pz./St.	€	EAN
626	25 x 20 x h 26	1.610	2	52,30-	8 016604 006265

3 LEVELS
 vedi pag. 301
 ver página 301
 siehe Seite 301
 see on page 301

★ NEW



PRODOTTO TOP
 38

Non inclusi
 No incluidos
 Nicht inbegriffen
 Not included

Ventilatore a batteria 21 V
 Due velocità di funzionamento (1700 - 2600 giri al minuto).
 Potenza nominale: 25 W.
 Inclinabile fino a 360°.
 Compatibile con tutte le batterie della linea POWER 21 V.

Ventilador a batería 21 V
 Dos velocidades de funcionamiento (1700 - 2600 rpm).
 Potencia nominal: 25 W.
 Se inclina hasta 360°.
 Compatible con todas las baterías de la línea POWER 21 V.

Ventilator Batteriebetrieben 21 V
 Zwei Betriebsgeschwindigkeiten (1700 - 2600 U/min).
 Nennleistung: 25 W.
 Neigt sich bis zu 360°.
 Mit allen Batterien der Linie POWER 21 V kompatibel.

Battery fan 21 V
 Two operating speeds (1700 - 2600 rpm).
 Rated power: 25 W.
 Tilts up to 360°.
 Compatible with all batteries of the POWER 21 V LINE.



Art.	cm	Gr.	Pz./St.	€	EAN
625	35 x 25 x h 35	2.190	2	56,40-	8 016604 006258

LOW MODE HIGH MODE
 vedi pag. 302
 ver página 302
 siehe Seite 302
 see on page 302

★ NEW



PRODOTTO TOP
 38

Non inclusi
 No incluidos
 Nicht inbegriffen
 Not included

Aspirapolvere e soffiatore a batteria 21 V
 Aspira polveri, piccole particelle di materiale e liquidi.
 Con filtro HEPA Classe M. 2 livelli di potenza.
 Funzione di sicurezza: si spegne quando l'acqua raggiunge un determinato livello nel serbatoio.
 Con tubo allungabile fino a 2 m, cinghia, bocchetta piatta e a lancia.
 Compatibile con le batterie da 2,6 Ah e 4,0 Ah della linea POWER 21 V.

Aspirador y soplador a batería 21 V
 Aspira polvo, pequeñas partículas de material y líquidos.
 Con filtro HEPA de clase M. 2 niveles de potencia.
 Función de seguridad: se apaga cuando el agua alcanza un determinado nivel en el tanque.
 Con manguera extensible hasta 2 m, correa, boquilla plana y de lanza.
 Compatible con las baterías de 2,6 Ah y 4,0 Ah de la línea POWER 21 V.

Staubsauger und Gebläse Batteriebetrieben 21 V
 Hohe Effizienz bei Staub, kleinen Partikeln und Flüssigkeit.
 Mit M-Class HEPA-Filter. 2 Leistungsstufen.
 Sicherheitsfunktion: Der Staubsauger schaltet sich ab, wenn das Wasser einen bestimmten Füllstand im Tank erreicht.
 Mit ausziehbarem Schlauch bis zu 2 m und Schultergurt. Mit flachem und spitzem Saugaufsatz ausgestattet.
 Kompatibel mit den 2,6 Ah und 4,0 Ah Batterien der Linie POWER 21 V.

Battery vacuum and blower 21 V
 It vacuums up dust, small material particles and liquids.
 With M-Class HEPA filter. 2 power levels.
 Safety function: the vacuum cleaner switches off when the water reaches a specified level in the tank.
 With extendable hose up to 2 m, shoulder strap, flat and straight lance.
 Compatible with 2.6 Ah and 4.0 Ah batteries of the POWER 21 V LINE.



Art.	cm	Gr.	Pz./St.	€	EAN
627	38 x 26 x h 29	3.360	1	99,70-	8 016604 006272

vedi pag. 303
 ver página 303
 siehe Seite 303
 see on page 303

Filtro HEPA
 Classe M, cattura il 99% delle polveri con dimensioni fino a 1 micron.
 Efficienza di filtrazione elevata per polveri del legno, ceramiche, plastiche e di vernici.
 Lavabile con acqua. Compatibile con art. 627 - Aspirapolvere 21 V

Filtro HEPA
 Clase M, captura el 99% del polvo de hasta 1 micrón de tamaño.
 Alta eficacia de filtración de polvo de madera, cerámica, plástico y pintura.
 Lavable con agua. Compatible con art. 627 - Aspirador 21 V.

HEPA-Filter
 Klasse M, fängt 99% des Staubs bis zu einer Größe von 1 Mikron auf.
 Hohe Filtereffizienz für Holz-, Keramik-, Kunststoff- und Lackstaub.
 Mit Wasser abwaschbar. Kompatibel mit Art. 627 - Staubsauger 21 V.

HEPA filter
 Class M, captures 99% of dust down to 1 micron in size
 High filtration efficiency for wood, ceramic, plastic and paint dust.
 Washable with water. Compatible with art. 627 - Vacuum cleaner 21 V.

★ NEW



Art.	cm	Pz./St.	€	EAN
628	22 x 12 x h 4	48	11,00-	8 016604 006289



21 V POWER LINE
2,6 Ah **stocker** LI-ION POWER

Batteria Power 21 V 2,6 Ah
Compatibile con i prodotti della linea Power 21 V.
Efficienza ed autonomia al tuo servizio (21,6 V - 2,6 Ah - 56 Wh).

Batería Power 21 V 2,6 Ah
Compatible con los productos de la línea Power 21 V.
Eficacia y autonomía a su servicio (21,6 V - 2,6 Ah - 56 Wh).

Batterie Power 21 V 2,6 Ah
Kompatibel mit der Linie POWER 21 V.
Mehr Performance für jede Anwendung (21,6 V - 2,6 Ah - 56 Wh).

Power Battery 21 V 2,6 Ah
Compatible with tools of the POWER 21 V Line.
Efficiency and autonomy at your side (21,6 V - 2,6 Ah - 56 Wh).



21 V POWER LINE
4,0 Ah **stocker** LI-ION POWER

Batteria Power 21 V 4,0 Ah
Compatibile con i prodotti della linea Power 21 V.
Efficienza ed autonomia al tuo servizio (21,6 V - 4,0 Ah - 86Wh).

Batería Power 21 V 4,0 Ah
Compatible con los productos de la línea Power 21 V.
Eficacia y autonomía a su servicio (21,6 V - 4,0 Ah - 86 Wh).

Batterie Power 21 V 4,0 Ah
Kompatibel mit der Linie POWER 21 V.
Mehr Performance für jede Anwendung (21,6 V - 4,0 Ah - 86 Wh).

Battery Power 21 V 4,0 Ah
Compatible with tools of the POWER 21 V Line.
Efficiency and autonomy at your side (21,6 V - 4,0 Ah - 86 Wh).



21 V POWER LINE
8,0 Ah **stocker** LI-ION POWER

Batteria Power 21 V 8,0 Ah
Compatibile con i prodotti della linea Power 21 V.
Potenza, efficienza ed autonomia al tuo servizio (21,6 V - 8,0 Ah - 172,80 Wh).

Batería Power 21 V 8,0 Ah
Compatible con los productos de la línea Power 21 V.
Fuerza, eficacia y autonomía a su servicio (21,6 V - 8,0 Ah - 172,80 Wh).

Batterie Power 21 V 8,0 Ah
Kompatibel mit der Linie POWER 21 V.
Mehr Performance für jede Anwendung (21,6 V - 8,0 Ah - 172,80 Wh).

Battery Power 21 V 8,0 Ah
Compatible with tools of the POWER 21 V Line.
Power, efficiency and autonomy at your side (21,6 V - 8,0 Ah - 172,80 Wh).



21 V POWER LINE
stocker

Caricabatterie doppio 21 V
Compatibile con tutte le batterie della linea POWER 21 V.

Cargador doble 21 V
Compatible con todas las baterías de la línea POWER 21 V.

Zweifach-Ladegerät 21 V
Kompatibel mit allen POWER 21 V-Batterien.

Double battery charger 21 V
Compatible with all batteries of the POWER 21 V LINE.

21 V POWER LINE
stocker

Cavo di alimentazione 160 21 V
Cavo compatibile con tutte le batterie della linea POWER 21 V. Alleggerisce il peso sulla mano.

Cable de alimentación 160 21 V
Cable compatible con todas las baterías de la línea POWER 21 V. Aligera el peso de la mano.

Kabel 160 21 V
Kompatibel mit allen POWER 21 V-Batterien. Für weniger Gewicht in der Hand und weniger Kraftaufwand.

Cable 160 21 V
Cable compatible with all batteries of the POWER 21 V LINE. Relieve the weight on your hand.

Art.	Pz./St.	€	EAN
312/8	12	27,05-	8 016604 103094

Art.	cm	Pz./St.	€	EAN
326	160	6	63,00-	8 016604 003264

21 V POWER LINE
stocker

CONSIGLIA AL CLIENTE LA BATTERIA OTTIMALE

RECOMIENDE LA MEJOR BATERÍA AL CLIENTE
EMPFEHLEN SIE DIE OPTIMALE BATTERIE
ADVISE THE CUSTOMER THE OPTIMAL BATTERY

Art.	Ø medio (cm) Ø promedio (cm) Durchschnittlicher Ø (cm) Average Ø (cm)	2,6 Ah Art. 312/7	4,0 Ah Art. 325	8,0 Ah Art. 328
621	2,5 cm	2.000	3.200	5.700
622	2,5 cm	2.000	3.200	5.700
623	2,5 cm	2.000	3.200	5.700
614	2,5 cm	2.000	3.200	5.700
616	6 cm	45-50	60-65	110-120
617	8 cm	45-50	60-65	110-120
619	8 cm	45-50	60-65	110-120
618	10 cm	45-50	60-65	110-120
615	10 cm	45-50	60-65	110-120
624		55 min.	90 min.	170 min.
629		Level 1: 45 min. Level 2: 35 min.	Level 1: 75 min. Level 2: 65 min.	Level 1: 150 min. Level 2: 140 min.
433		13 min.	19 min.	35 min.
434		Level 1 (2x): 25 min. Level 2 (2x): 15 min. Level 3 (2x): 9 min.	Level 1 (2x): 37 min. Level 2 (2x): 23 min. Level 3 (2x): 14 min.	Level 1 (2x): 70 min. Level 2 (2x): 48 min. Level 3 (2x): 29 min.
625		Low: 7 h. High: 3 h.	Low: 10,5 h. High: 4,5 h.	Low: 22,10 h. High: 8,45 h.
626		Level 1: 360 min. Level 2: 165 min. Level 3: 105 min.	Level 1: 570 min. Level 2: 240 min. Level 3: 180 min.	Level 1: 1.110 min. Level 2: 570 min. Level 3: 359 min.
627		Level 1: 30 min. Level 2: 19 min.	Level 1: 47 min. Level 2: 22 min.	
404		Level 1: 305 min. Level 2: 145 min.	Level 1: 450 min. Level 2: 240 min.	Level 1: 855 min. Level 2: 465 min.
405		Level 1: 305 min. Level 2: 145 min.	Level 1: 450 min. Level 2: 240 min.	Level 1: 855 min. Level 2: 465 min.
406		Level 1: 305 min. Level 2: 145 min.	Level 1: 450 min. Level 2: 240 min.	Level 1: 855 min. Level 2: 465 min.

Numero di tagli / Número de cortes /
Anzahl der Schnitte / Number of cuts *

Tempo di lavoro / Tiempo de trabajo /
Arbeitszeit / Work time *

* Il dato può variare in base all'essenza del legno su cui si lavora, alla pianta e a fattori ambientali che influenzano la batteria (temperatura, umidità ecc...)
* El dato puede variar en función de la especie de madera que se trabaje, de la planta y en función de los factores ambientales que afectan a la batería (temperatura, humedad, etc.)
* Die Laufzeit kann, durch Beschaffenheit des verwendeten Holzes und durch Umwelteinwirkungen wie extreme Temperaturen usw, abweichen.
* The data may vary depending on the wood species being worked on, the plant, and depending on environmental factors affecting the battery (temperature, humidity, etc.)

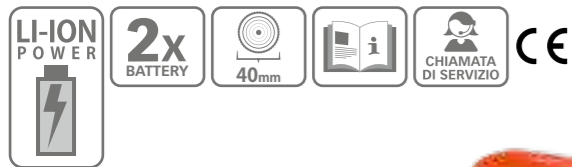

Forbice Titania E-40 TP
 Eccezionale capacità di taglio, fino a 40 mm. Motore brushless.
 2 modalità di funzionamento: progressivo e automatico.
 Regolazione dell'apertura della lama personalizzabile.
 Autonomia: 7 ore di lavoro continuato, con 2 batterie.
 Sistema anti-taglio di protezione per le dita.

Tijera Titania E-40 TP
 Excepcional capacidad de corte, hasta 40 mm. Motor brushless.
 2 modos de funcionamiento: progresivo y automático.
 Ajuste de apertura de las hojas personalizable. Autonomía: 7 horas de trabajo continuo, con 2 baterías. Sistema anti-corte de protección de dedos.

Schere Titania E-40 TP
 Aussergewöhnliche Schneidleistung, bis zu 40 mm. Bürstenloser Motor.
 2 Betriebsmodi: progressiv und automatisch.
 Individuell anpassbare Klingenöffnung. Arbeitszeit: bis zu 7 Stunden mit zwei Batterien. Sicherheitssystem gegen Schnittverletzungen.

Pruning shears Titania E-40 TP
 Exceptional cutting capacity, up to 40 mm. Brushless motor.
 2 operating modes: progressive and automatic.
 Customizable blade opening adjustment. Battery life: 7 hours of continued operation, with two batteries. Anti-cut finger protection system.

Art.	cm	Gr.	Pz./St.	€	EAN
315	33	1.300	2	464,00-	8 016604 003158

Dati tecnici - Datos técnicos - Technische Daten - Technical data	
Batteria Bateria Batterie Battery	2,6 Ah/21,6 V
Potenza del motore Potencia del motor Motorleistung Motor power	400 W
Tempo di ricarica Tiempo de carga Ladezeit Recharging time	2 h



vedi pag. 304
 ver página 304
 siehe Seite 304
 see on page 304



Forbice Vulcano E-30 TP
 2 modalità di taglio: progressivo e automatico.
 Apertura della lama regolabile in ogni punto. Motore brushless.
 Impugnatura ergonomica e led d'indicazione del livello di carica.
 Autonomia: 6 ore di lavoro continuato, con 2 batterie.

Mango ergonómico y LED indicador de nivel de carga.
 Autonomía: 6 horas de trabajo continuo, con dos baterías.

Schere Vulcano E-30 TP
 2 Betriebsmodi: progressiv, mit progressiven Bedienschalter für bessere Kontrolle und automatisch, für mehr Schnelligkeit.
 Bürstenloser Motor. Individuell anpassbare Klingenöffnung für jeden Durchmesser. Ergonomischer Griff und LED-Ladestandsanzeige.
 Arbeitszeit: 6 Stunden, mit zwei Batterien. Wartungskit enthalten.

Pruning shears Vulcano E-30 TP
 2 operating modes: progressive, for advanced control, and automatic, for quicker operations. Customizable blade's aperture. Brushless motor. Ergonomic grip. Equipped with a LED that indicates the battery-level. Battery life: 6 hours of continued operation, with two batteries.

Art.	cm	Gr.	Pz./St.	€	EAN
311	28	900	2	366,00-	8 016604 003110

Dati tecnici - Datos técnicos - Technische Daten - Technical data	
Batteria Bateria Batterie Battery	2,5 Ah/14,4 V
Potenza del motore Potencia del motor Motorleistung Motor power	150 W
Tempo di ricarica Tiempo de carga Ladezeit Recharging time	2,5 h



vedi pag. 305
 ver página 305
 siehe Seite 305
 see on page 305



Forbice Vulcano E-25 TR
 Operazioni rapide con il taglio automatico.
 Motore brushless.
 Apertura della lama regolabile su 20 o 25 mm.
 Impugnatura ergonomica e led d'indicazione del livello di carica.
 Autonomia: 6 ore di lavoro continuato, con 2 batterie.

Tijera Vulcano E-25 TR
 Operaciones rápidas con el corte automático.
 Motor brushless. Abertura de la hoja ajustable a 20 o 25 mm.
 Mango ergonómico y LED indicador de nivel de carga.
 Autonomía: 6 horas de trabajo continuo, con dos baterías.

Schere Vulcano E-25 TR
 Präzises und schnelles Schneiden durch automatischen Betriebsmodus.
 Bürstenloser Motor. Einstellbare Klingenöffnung von 20 oder 25 mm.
 Ergonomischer Griff und LED-Ladestandsanzeige.
 Arbeitszeit: 6 Stunden, mit zwei Batterien.

Pruning shears Vulcano E-25 TR
 Quick operations with the automatic-cutting. Brushless motor.
 Adjustable blade's aperture on 20 or 25 mm. Ergonomic grip.
 Equipped with a LED that indicates the battery-level.
 Battery life: 6 hours of continued operation, with two batteries.

Dati tecnici - Datos técnicos - Technische Daten - Technical data	
Batteria Bateria Batterie Battery	2,5 Ah/14,4 V
Potenza del motore Potencia del motor Motorleistung Motor power	150 W
Tempo di ricarica Tiempo de carga Ladezeit Recharging time	2,5 h



vedi pag. 306
 ver página 306
 siehe Seite 306
 see on page 306

Art.	cm	Gr.	Pz./St.	€	EAN
310	29	900	2	294,00-	8 016604 003103



Forbice Vulcano E-25 TR Basic
 Corrisponde esattamente all'Art. 310, ma nella fornitura:
 - è inclusa una sola batteria;
 - non è inclusa la valigetta.
 Autonomia: 3 ore di lavoro continuato.

Tijera Vulcano E-25 TR Basic
 Corresponde exactamente al art.310, pero en el suministro:
 - solo se incluye una batería;
 - el maletín no está incluido.
 Autonomía: 3 horas de trabajo continuo.

Schere Vulcano E-25 TR Basic
 Sie entspricht genau dem Art. 310, der Umfang beinhaltet jedoch:
 - nur eine Batterie;
 - keinen Koffer.
 Arbeitszeit: 3 Stunden.

Pruning shears Vulcano E-25 TR Basic
 It is exactly the same product as Art. 310, but the supply:
 - includes only one battery;
 - doesn't include the suitcase.
 Battery life: 3 hours of continued operation.

Dati tecnici - Datos técnicos - Technische Daten - Technical data	
Batteria Bateria Batterie Battery	2,5 Ah/14,4 V
Potenza del motore Potencia del motor Motorleistung Motor power	150 W
Tempo di ricarica Tiempo de carga Ladezeit Recharging time	2,5 h



vedi pag. 306
 ver página 306
 siehe Seite 306
 see on page 306

Art.	cm	Gr.	Pz./St.	€	EAN
314	29	900	2	207,00-	8 016604 003141



Forbice Vulcano E-35 TPC

2 modalità di taglio: progressivo e automatico. Impugnatura ergonomica e led d'indicazione del livello di carica sulla batteria. Autonomia: 9 ore di lavoro continuato. Motore brushless per una manutenzione ridotta. Il sistema a zaino ergonomico permette un'ottimale distribuzione del peso nella zona lombare.

Tijera Vulcano E-35 TPC

2 modos de corte: progresivo y automático. Mango ergonómico y LED indicador de nivel de carga. Autonomía: 9 horas de trabajo continuo. Motor brushless para un mantenimiento reducido. El sistema de mochila ergonómica permite una distribución óptima del peso en la zona lumbar.

Schere Vulcano E-35 TPC

2 Betriebsmodi: progressiv und automatisch. Ergonomischer Griff und LED Ladestandanzeige. Arbeitszeit: 9 Stunden. Wartungskit enthalten. Bürstenloser Motor für geringeren Wartungsaufwand. Das ergonomische Rucksacksystem ermöglicht eine optimale Gewichtsverteilung im Lendenwirbelbereich.

Pruning shears Vulcano E-35 TPC

2 operating modes: progressive and automatic. Ergonomic grip. Equipped with a LED that indicates the charge-level on the battery. Battery life: 9 hours of continued operation. Brushless motor for reduced maintenance. The ergonomic backpack system offers an optimal distribution of the weight in the lumbar area.

Art.	cm	Gr.	Pz./St.	€	EAN
313	30,5	900	2	628,00-	8 016604 003134

Dati tecnici - Datos técnicos - Technische Daten - Technical data	
Peso totale Peso total Total Gewicht Total weight	3200 g
Batteria Batería Batterie Battery	4,4 Ah/43,2 V
Lunghezza cavo Longitud cable Kabellänge Cable's length	160 cm
Potenza del motore Potencia del motor Motorleistung Motor power	300 W
Tempo di ricarica Tiempo de carga Ladezeit Recharging time	4,5 h

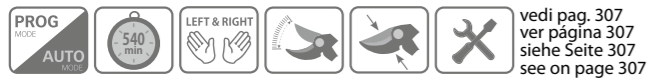

vedi pag. 307
ver página 307
siehe Seite 307
see on page 307

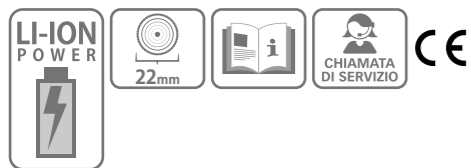

cabezal delgado e inclinado con un ángulo de 10° ofrece una amplia visión del corte. Apertura de la hoja regulable en 22 o 16 mm, con bloqueo de seguridad de la hoja. Motor sin escobillas. LED para monitorizar la batería. Incluye batería, cargador doble y kit de mantenimiento.

Kantia E-22 TR Langarmschere und Teleskopschere

Fixe Langarmschere oder Teleskopschere aus Aluminium mit perfekter Balance. Schmäler und um 10° geneigter Schneidkopf für optimale Sichtverhältnisse beim Schneiden. Regulierbare Klingeöffnung auf 22 oder 16 mm, mit Sicherheitsverriegelung. Bürstenloser Motor und LED-Anzeige für den Ladezustand. Batterie, doppeltes Ladekabel und Instandhaltungskit inbegriffen.

Pruning shears Kantia E-22 TR long handled and telescopic handled

With fixed or telescopic aluminium handle, for an excellent balance of the weight. Slim and 10° inclined cutting head for an excellent view of the cut. Blade opening adjustable to 22 or 16 mm, with security blade's block. Brushless motor. LED to monitor battery life. Battery, double charger and maintenance kit included.

Art.	cm	Gr.	Pz./St.	€	EAN
610	180	1.550	1	293,00-	8 016604 906107
611	180-300	1.950	1	323,00-	8 016604 906114

Dati tecnici - Datos técnicos - Technische Daten - Technical data	
Batteria Batería Batterie Battery	2,5 Ah/7,2 V
Potenza del motore Potencia del motor Motorleistung Motor power	180 W
Tempo di ricarica Tiempo de carga Ladezeit Recharging time	2,5 h



vedi pag. 308
ver página 308
siehe Seite 308
see on page 308



Forbice Kantia E-22 TR

Apertura della lama regolabile su 22 o 16 mm. Batteria fast click-in per una sostituzione facile e veloce, con LED per mantenerne sotto controllo la durata. Presa ergonomica e peso ridotto per non affaticare il polso. Autonomia: 1,5 ore di lavoro continuato. Batteria, caricabatteria doppio e kit manutenzione inclusi.



Tijera Kantia E-22 TR

Apertura de la hoja regulable en 22 o 16 mm. Batería de clic

Dati tecnici - Datos técnicos - Technische Daten - Technical data	
Batteria Batería Batterie Battery	2,5 Ah/7,2 V
Potenza del motore Potencia del motor Motorleistung Motor power	180 W
Tempo di ricarica Tiempo de carga Ladezeit Recharging time	2,5 h



vedi pag. 309
ver página 309
siehe Seite 309
see on page 309

rápido para un reemplazo fácil y rápido, con LED para mantener la vida útil de la batería bajo control. Empuñadura ergonómica y peso reducido para no forzar la muñeca. Autonomía: 1,5 horas de trabajo continuo. Incluye batería, cargador doble y kit de mantenimiento.

Schere Kantia E-22 TR

Regulierbare Klingeöffnung auf 22 oder 16 mm. Fast Klick-In Batterie für einfaches und schnelles Wechseln und LED-Anzeige für optimale Kontrolle des Ladezustands. Leichter und ergonomischer Griff für Schonung des Handgelenks. Arbeitszeit: 1,5 h durchgehende Arbeitszeit. Batterie, doppeltes Ladekabel und Instandhaltungskit inbegriffen.

Pruning shears Kantia E-22 TR

Blade opening adjustable to 22 or 16 mm. Fast click-in battery for a quick and easy replacement, with LED to monitor battery life. Ergonomic grip and low weight to avoid straining the wrist. Battery life: 1,5 hours of continued operation. Battery, double charger and maintenance kit included.

Art.	cm	Gr.	Pz./St.	€	EAN
309	28	780	2	145,00-	8 016604 003097



Espositore isola Forbice Art. 309

Per un'esposizione ottimale dell'art. 309

Expositor aislado tijera Art. 309

Para una exposición óptima del art. 309

Verkaufsständer Insel Schere Art. 309

Für eine optimale Produktpräsentation der Art. 309

Display island Pruning Shears Item 309

For an optimal exposure of item 309

Art.	cm	€	EAN
87			8 016604 000874

* fino ad esaurimento
* hasta agotamiento
* solange der Vorrat reicht
* While supplies last

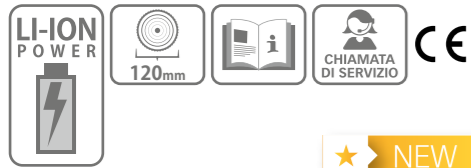

☑ Motosega ALL-ROUNDER E-150 LA

Il cambio catena è facilitato da un sistema semplice e veloce. Lubrificazione catena automatica. Motore brushless per una lunga durata. Velocità di taglio: 12 m/s. Fino a 50 tagli con un diametro medio di 8 cm. Avviamenti accidentali sono evitati dal tasto di sicurezza. Con batteria Li-Ion da 16,8 V ricaricabile. Carica batterie doppio e cacciavite per tensione catena in dotazione.

☑ Motosierra ALL-ROUNDER E-150 LA

El cambio de cadena se facilita mediante un sistema sencillo y



rápido. Lubricación automática de la cadena. Motor brushless para una larga duración. Velocidad de corte: 12 m/s. Hasta 50 cortes con un diámetro mediodo 8 cm. Arranques accidentales se evitan mediante el botón de seguridad. Con batería recargable de iones de litio de 16,8 V. Cargador doble destornillador para tensar la cadena en dotación.

☑ Motorsäge ALL-ROUNDER E-150 LA

Vereinfachtes System für den Wechsel der Kette. Automatische Schmierung der Kette. Bürstenloser Motor für eine lange Lebensdauer. Schnittgeschwindigkeit: 12 m/s. Bis zu 50 Schnitte bei einem Durchmesser von 8 cm. Sicherheitstaste verhindert unbeabsichtigtes Auslösen. Mit einer aufladbarem 16,8 V Batterie Li-Ion. Doppelladegerät inbegriffen.

☑ Chainsaw ALL-ROUNDER E-150 LA

Easy chain substitution thanks to an easy and fast system. Automatic chain lubrication. Brushless motor, for a long lasting product. Cutting speed 12 m/s. Up to 50 cuts with a 8 cm average diameter. Accidental starts are prevented by the safety button. With 16,8 V rechargeable Li-Ion battery. Double battery charger and chain tensioning screwdriver included.

Art.	cm	Gr.	Pz./St.	€	EAN
321	43	1.135	2	150,50-	8 016604 003219



vedi pag. 310
ver página 310
siehe Seite 310
see on page 310

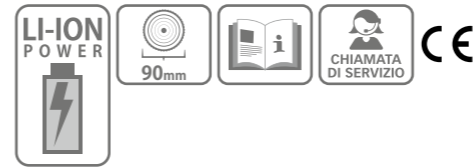

☑ Motosega ALL-ROUNDER E-100 UC

Sistema di tensionatura automatica della catena. Il cambio catena è facilitato da un sistema semplice e veloce. Motore brushless per una lunga durata. Velocità di taglio: 10 m/s. Fino a 90-120 tagli con un diametro medio di 6 cm. Avviamenti accidentali sono evitati dal tasto di sicurezza. Con batteria Li-Ion da 16,8 V ricaricabile. Carica batterie doppio in dotazione.

☑ Motosierra ALL-ROUNDER E-100 UC

Sistema automático de tensado de cadena. El cambio de



cadena se facilita mediante un sistema sencillo y rápido. Motor brushless para una larga duración. Velocidad de corte: 10 m/s. Hasta 90-120 cortes con un diámetro mediodo 6 cm. Arranques accidentales se evitan mediante el botón de seguridad. Con batería recargable de iones de litio de 16,8 V. Cargador doble en dotación.

☑ Motorsäge ALL-ROUNDER E-100 UC

Automatische Kettenspannung. Vereinfachtes System für den Wechsel der Kette. Bürstenloser Motor für eine lange Lebensdauer. Schnittgeschwindigkeit: 10 m/s. Bis zu 90-120 Schnitte bei einem Durchmesser von 6 cm. Sicherheitstaste verhindert unbeabsichtigtes Auslösen. Mit einer aufladbarem 16,8 V Batterie Li-Ion. Doppelladegerät inbegriffen.

☑ Chainsaw ALL-ROUNDER E-100 UC

Automatic chain tensioning system. Easy chain substitution thanks to an easy and fast system. Brushless motor, for a long lasting product. Cutting speed 10 m/s. Up to 90-120 cuts with a 6 cm average diameter. Accidental starts are prevented by the safety button. With 16,8 V rechargeable Li-Ion battery. Double battery charger included.

Dati tecnici - Datos técnicos - Technische Daten - Technical data

Batteria Bateria	2,0 Ah/16,8 V
Batterie Battery	
Potenza del motore Potencia del motor	300 W
Motorleistung Motor power	
Tempo di ricarica Tiempo de carga	2,5 h
Ladezeit Recharging time	



vedi pag. 311
ver página 311
siehe Seite 311
see on page 311

Art.	cm	Gr.	Pz./St.	€	EAN
320	38	940	2	142,00-	8 016604 003202

* fino ad esaurimento
* hasta agotamiento
* solange der Vorrat reicht
* While supplies last



☑ Espositore isola Motosega

Per un'esposizione ottimale dell'art. 320 e 321

☑ Expositor aislado Motosierra

Para una exposición óptima del art. 320 y 321

☑ Verkaufsständer Insel Motorsäge

Für eine optimale Produktpräsentation der Art. 320 und 321

☑ Display island Chainsaw

For an optimal exposure of item 320 and 321

* fino ad esaurimento
* hasta agotamiento
* solange der Vorrat reicht
* While supplies last

Art.	cm	€	EAN
86			8 016604 000867



Stocker estensione di garanzia 60 mesi

Sulla carta garanzia Stocker è riportato un codice univoco che il cliente utilizza per registrare il proprio prodotto online ed estendere così la copertura da garanzia fino a 60 mesi (5 anni).
Maggiori informazioni su: www.stockergarden.com/welcome

Stocker extensión de garantía 60 meses

En la tarjeta garantía Stocker hay un código unívoco que el cliente utiliza para registrar su producto online y, por lo tanto, extender la cobertura de la garantía hasta 60 meses (5 años). Más informaciones en: www.stockergarden.com/es/welcome

Stocker Garantieverlängerung 60 Monate

Auf der Stocker Garantiekarte ist eine eindeutige Nummer abgebildet, mit welcher der Nutzer die Garantie des Produktes bis auf 60 Monate (5 Jahre) verlängern kann. Weitere Informationen finden sie auf der Website unter: www.stockergarden.com/de/welcome

Stocker warranty extension 60 months

There is a code on the Stocker warranty card, which the customer shall use to register the product online and thereby obtain the warranty extension to 60 months (5 years). For more information, please visit www.stockergarden.com/en/welcome

Art.	Mercati/Markets	Pz./St.	€	EAN
090		1	20,00-	8 016604 000904

Olio lubrificante biodegradabile per catena motosega

Aceite lubricante biodegradable para cadenas de motosierra

Bio-Kettenöl für Motorsäge

Biodegradable lubricating oil for chainsaw chain



* fino ad esaurimento
* hasta agotamiento
* solange der Vorrat reicht
* While supplies last



Art.	lt.	Pz./St.	€	EAN
9086	1	16	14,30-	8 016604 090868
9087	2	9	25,95-	8 016604 090875

Olío spray multiuso

Per la manutenzione di forbici elettriche e manuali. Protegge e pulisce le lame per una maggiore durata. Ugello di precisione in ottone per una facile e accurata applicazione.

Aceite spray multiuso

Para el mantenimiento de tijeras eléctricas y manuales. Protege y limpia las hojas para una duración mayor. Boquilla de latón de precisión para una aplicación fácil y precisa.

Öl Multifunktionspray

Für die Wartung von elektrischen und manuellen Scheren. Schützt und reinigt Klingen für eine längere Lebensdauer. Mit Messing-Präzisionsdüse für eine einfache und genaue Anwendung.

Multifunction spray-oil

For the maintenance of electric and manual pruning shears. It protects and cleans the blades for a longer durability. With brass precision-nozzle for an easy and accurate application.



Art.	ml	Pz./St.	€	EAN
9082	100	12	7,80-	8 016604 090820



Grasso spray lubrificante

Per la manutenzione di forbici elettriche e manuali. Contribuisce a garantire una lunga durata della forbice. Ugello di precisione in ottone per una facile e accurata applicazione.

Grasa spray lubricante

Para el mantenimiento de tijeras eléctricas y manuales. Ayuda a asegurar una larga duración de la tijera. Boquilla de latón de precisión para una aplicación fácil y precisa.

Sprüh-Fett

Für die Wartung von elektrischen und manuellen Scheren. Trägt zu einer längeren Lebensdauer der Schere bei. Mit Messing-Präzisionsdüse für eine einfache und genaue Anwendung.

Lubricant spray-grease

For the maintenance of electric and manual pruning shears. Contributes to a longer durability of the shears. With brass precision-nozzle for an accurate application.



Art.	ml	Pz./St.	€	EAN
9083	100	12	8,25-	8 016604 090837



Bladeup 250 pulitore per lame e catene

Per la manutenzione e la pulizia di lame e catene di attrezzi elettrici e manuali. Azione detergente sui depositi di linfa e di polvere per migliorare le performance del tuo attrezzo.

Bladeup 250 limpiador de cuchillas y cadenas

Para el mantenimiento y la limpieza de hojas y cadenas de herramientas eléctricas y manuales. Acción limpiadora en los depósitos de savia y polvo para mejorar el rendimiento de tu herramienta.

Bladeup 250 Klingen- und Kettenreiniger

Für das Säubern und Instandhalten von Klingen und Ketten manueller und elektrischer Geräte. Einfache Reinigung der Oberflächen von Harzrückständen und Schmutz für einen perfekten Schnitt.

Bladeup 250 blade and chain cleaner

For the maintenance and cleaning of blades and chains of electric and manual tools. Cleansing action on lymph and dust deposits to improve the performance of your tool.



Art.	ml	Pz./St.	€	EAN
9085	250	12	9,40-	8 016604 090851





☑ Fodero per batterie

Con 3 tasche, adatte per tutte le batterie con sistema click-in per forbici elettriche. In nylon, con rivestimento interno in PVC che mantiene salde le batterie e assicura una lunga durata del fodero. Maggiore comodità grazie all'elastico regolabile per il fissaggio alla gamba.

☑ Funda para baterías

Con 3 bolsillos, aptos para todas las baterías con sistema click-in para tijeras eléctricas. De nylon, con revestimiento interno de PVC que mantiene firmes las baterías y garantiza una larga duración de la funda. Mayor comodidad gracias al elástico ajustable para la fijación a la pierna.

☑ Batterientasche

Mit 3 Taschen, geeignet für alle Batterien mit dem Click-In-System für elektrische Scheren. Aus Nylon mit PVC verstärkter Innenseite für einen besseren Halt der Batterien und einer längeren Lebensdauer der Tasche. Elastische Bänder zum Anbringen der Tasche am Bein für mehr Stabilität.

☑ Batteries bag

With 3 pockets, suitable to carry all click-in batteries for electric shears. Made of nylon, with internal PVC lining for more stability of the batteries and to ensure a longer durability of the bag. The adjustable elastic allows to fasten it to the leg for advanced comfort.



Art.	cm	Gr.	Pz./St.	€	EAN
427	21 x 7 x h 12	185	6	12,85-	8 016604 004278

* fino ad esaurimento
* hasta agotamiento
* solange der Vorrat reicht
* While supplies last



☑ Fodero per forbici elettriche

In nylon, con rivestimento interno in PVC che mantiene salda la forcice ed assicura una lunga durata del fodero. Maggiore stabilità e sicurezza con gli elastici regolabili per il fissaggio alla gamba.

☑ Funda para tijeras eléctricas

De nylon, con revestimiento interno de PVC que mantiene firme la tijera y garantiza una larga duración de la funda. Mayor estabilidad y seguridad con bandas elásticas ajustables para la fijación a la pierna.

☑ Tasche für elektrische Baumscheren

Aus Nylon, mit PVC verstärkter Innenseite für einen besseren Halt der Schere und einer längeren Lebensdauer der Tasche. Elastische Bänder, zum Anbringen der Schere am Bein, für mehr Stabilität.

☑ Sheath for electric shears

Made of nylon, with internal PVC lining that gives more stability to the shears and ensures a longer durability of the sheath. The adjustable elastics allow to fasten it to the leg for advanced stability and safety.



Art.	cm	Gr.	Pz./St.	€	EAN
426	30	265	6	14,25-	8 016604 004261
429	34	284	6	15,40-	8 016604 004292

☑ Fodero per motoseghe elettriche

In nylon, con inserto in metallo per un trasporto sicuro della motosega. Stabilità ottimale grazie alla fascia regolabile per fissaggio alla coscia e al passante per la cintura. La cinghia con bottone automatico consente di assicurare facilmente la motosega al fodero.

☑ Funda para motosierras eléctricas

De nylon, con inserto metálico para el transporte seguro de la motosierra. Óptima estabilidad gracias a la banda ajustable para la fijación a la pierna y al cinturón. El cinturón con botón a presión permite asegurar fácilmente la motosierra a la funda.

☑ Tasche für elektrische Motorsägen

Aus Nylon, mit Metalleinlage für einen sicheren Transport der Motorsäge. Optimale Stabilität und Tragekomfort dank des verstellbaren Beingurts und der Gürtelschlaufe. Zusätzliche Lasche mit Druckknopfverschluss für das Fixieren der Motorsäge.

☑ Sheath for electric chainsaws

Made of nylon, with metal insert for safe transport of the chainsaw. Optimal stability thanks to the adjustable straps for attachment to the thigh and the belt loop. The strap has a snap button that allows you to easily secure the chainsaw to the sheath.



Art.	cm	Gr.	Pz./St.	€	EAN
430	47	625	6	40,90-	8 016604 004308

☑ Ordine Zaino per attrezzi di potatura

In PVC: idrorepellente e facile da pulire. Spallacci imbottiti e regolabili. Parte laterale multi tasca: per contenere ciò di cui avete più bisogno durante le ore di lavoro. Parte laterale con tasca a vista: utile per contenere piccoli strumenti, viteria e utensili di piccole dimensioni.

☑ Ordine Mochila para herramientas de poda

De PVC: repelente al agua y fácil de limpiar. Correas para los hombros acolchadas y ajustables. Parte lateral multibolsillo: para guardar lo que más necesitas en horas de trabajo. Parte lateral con bolsillo a la vista: útil para guardar pequeñas herramientas, tornillos y herramientas de pequeñas dimensiones.

☑ Ordine Rucksack für Baumschnittgeräte

Aus PVC: wasserabweisend und leicht zu reinigen. Gefütterte und regulierbare Schulterriemen. Multifunktionsfächer: Verstaue die wichtigsten Utensilien die du während deiner Arbeit brauchst. Seitenteil mit Netztasche: Ideal für kleine Geräte, Schrauben oder ähnliche Kleinteile welche man nicht verlieren will.

☑ Ordine Backpack for pruning tools

PVC material: repellent and easy to clean. Padded and adjustable shoulder straps. Multi-pocket side section: to hold what you need during working hours. 3. Side part with clearview pocket: useful for holding small tools, screws and small gear that you don't want to lose inside the backpack.



Art.	cm	Pz./St.	€	EAN
431	60 x 30 x h 15	2	54,80-	8 016604 004315

☑ Cinghia a tracolla per attrezzi su asta

Scarica il peso dell'attrezzo e stabilizza il trasporto. Realizzata in resistente poliestere. Fettuccia di fissaggio antiscivolo in gomma e con velcro esterno per mantenere la posizione sul manico. Ideale in combinazione con tutti gli attrezzi su asta.

☑ Correa de hombro para herramientas con mango largo

Alivia el peso de la herramienta y estabiliza el transporte. Fabricada en poliéster resistente. Correa de sujeción antideslizante de goma con velcro externo para mantener la posición en el mango. Ideal en combinación con todas las herramientas con mango largo.

☑ Schulterriemen für Langarmgeräte

Für eine körperliche Entlastung vom Gewicht des Geräts und einen vereinfachten Transport. Hergestellt aus strapazierfähigem Polyester. Rutschfester Befestigungsriemen mit außenliegendem Klettverschluss, um die Position optimal am Stiel zu halten. Ideal in Kombination mit allen an Stielen befestigten Werkzeugen.

☑ Shoulder strap for handle tools

Spreads the weight of the tool and stabilises transport. Made of durable polyester. Non-slip rubber fixing strap with external Velcro to maintain position on the handle. Ideal in combination with all handle tools.



Art.	cm	Gr.	Pz./St.	€	EAN
586	75 - 125	150	12	12,50-	8 016604 005862





227

Guanti antitaglio per motosega
Elevata protezione grazie al doppio strato antitaglio in fibra di aramide. DPI Cat. 1. Insetti di gomma sul dorso garantiscono l'assorbimento degli urti.

Guantes anticorte para motosierra
Elevada protección gracias a la doble capa anticorte de fibra de aramida. EPI Cat. 1. Las inserciones de goma en el dorso garantizan la absorción de impacto.

Schnittfeste Handschuhe für Motorsäge
Hoher Schutz dank doppelter, schnittfester Aramid-Faser Schicht. PSA Kat. 1. Kunststoffeinsätze am Handrücken garantieren erhöhten Stoßschutz.

Anti-cut gloves for chainsaw
High protection due to the double anti-cut aramid fiber layer. PPE Cat. 1. Rubber pads on the back guarantee high shock absorption.



Art.	mis./Gr.	col./Farbe	Pz./St.	€	EAN
24112	9 / M	■	6	35,00-	8 016604 241123
24113	10 / L	■	6	35,00-	8 016604 241130
24114	11 / XL	■	6	35,00-	8 016604 241147
24119	12 / XXL	■	6	35,00-	8 016604 241192



226

Guanti invernali antitaglio per motosega
Elevata protezione grazie al doppio strato antitaglio in fibra di aramide. DPI Cat. 1. Mani asciutte e calde grazie al tessuto idrorepellente e imbottito con Thinsulate.

Guantes invernales anticorte para motosierra
Elevada protección gracias a la doble capa anticorte de fibra de aramida. EPI Cat. 1. Manos secas y calidas gracias al tejido repelente al agua y acolchado con Thinsulate.

Schnittfeste Winterhandschuhe Handschuhe für Motorsäge
Hoher Schutz dank doppelter, schnittfester Aramid-Faser Schicht. PSA Kat. 1. Trockene und warme Hände dank wasserabweisendem Material und Thinsulate-Fütterung.

Anti-cut winter gloves for chainsaw
High protection due to the double anti-cut aramid fiber layer. PPE Cat. 1. Dry hands thanks to the water-repellent fabric and warm thanks to the Thinsulate lining.



Art.	mis./Gr.	col./Farbe	Pz./St.	€	EAN
23112	9 / M	■	6	38,30-	8 016604 231124
23113	10 / L	■	6	38,30-	8 016604 231131
23114	11 / XL	■	6	38,30-	8 016604 231148
23115	12 / XXL	■	6	38,30-	8 016604 231155

Cuffia antirumore
Ideale per proteggerti dai rumori forti durante le operazioni in campo: SNR 26 dB. Attutisce i rumori di attrezzi e macchinari, più sicurezza per il tuo udito. Morbidi cuscinetti imbottiti per un maggiore comfort, ampio spazio all'interno delle coppe. Archetto regolabile per adattarsi ad ogni misura. Estremamente leggera, permette di indossarle per periodi lunghi, solo 165 gr.

Protector auditivo
Ideal para protegerte de ruidos fuertes durante las operaciones en campo: SNR 26 dB. Amortigua los ruidos de herramientas y maquinarias, más seguridad para tu oído. Suaves almohadillas acolchadas para mayor comodidad, amplio espacio en el interior de las copas. Arco ajustable para adaptarse a cualquier talla. Extremadamente ligero, permite usarlo por largos periodos, solo 165 gr.

Gehörschutz
Ideal zum Schutz vor lauten Geräuschen während der Arbeit in Haus Hof und Garten: SNR 26 dB. Dämpft die Geräusche von Werkzeugen und Maschinen, mehr Sicherheit für Ihr Gehör. Weich gepolsterte Pads für mehr Komfort, viel Platz für die Ohrmuschel. Verstellbarer Kopfbügel zur Anpassung an jede Größe. Extrem leicht, komfortabel bei langem Tragen, nur 165 g.

Hearing protector
Ideal for protecting you from loud noises during your activities: SNR 26 dB. Muffles the noises of tools and machinery, more safety for your hearing. Soft padded pads for greater comfort, wide space inside the cups. Adjustable headband easy to adapt to any size. Extremely light, it allows you to wear it for long periods, only 165 gr.



Art.	Gr.	Pz./St.	€	EAN
24115	165	12	23,95-	8 016604 241154



Occhiale protettivo Matador
Trattamento lenti: antigraffio, antiappannante, antistatico. Inclinazione delle lenti regolabile individualmente.

Gafas de protección Matador
Tratamiento de lentes: antiarañazos, antivaho, antiestático. Ángulo de lente ajustable individualmente.

Matador Schutzbrille
Gläserbehandlung: kratzfest, beschlagfrei und antistatisch. Bügelneigung individuell einstellbar.

Matador protective goggles
Lens treatment: anti-scratch, anti-fog, antistatic. Individually adjustable lens inclination.



Art.	Pz./St.	€	EAN
24116	10	14,65-	8 016604 241161

Occhiale da sole protettivo Voltor
Trattamento lenti: antigraffio. Il profilo superiore in gomma protegge contro la penetrazione di corpi estranei dall'alto.

Gafas de sol protectoras Voltor
Tratamiento de la lente: resistente a los arañazos. El perfil de goma superior protege contra la penetración de cuerpos extraños desde arriba.

Voltor Sonnenbrille - Schutzbrille
Robuste und kratzeste Gläser. Maximaler Schutz durch Gummiprofil an Brillenoberkante.

Voltor protective sunglasses
Lens treatment: anti-scratch. The upper edge of the frame increases safety by preventing the ingress of foreign bodies from above.



Art.	Pz./St.	€	EAN
24117	10	16,15-	8 016604 241178

Copri occhiale protettivo Ontor
Trattamento lenti: antigraffio, antiappannante, antistatico. Lunghezza e inclinazione stanghette regolabile individualmente.

Antiparras de protección ocular Ontor
Tratamiento de lentes: antiarañazos, antivaho, antiestático. Longitud y ángulo de las patillas ajustables individualmente.

Ontor Überbrille - Schutzbrille
Gläserbehandlung: kratzfest, beschlagfrei und antistatisch. Bügelneigung und Bügellänge individuell einstellbar.

Ontor protective eyewear cover
Lens treatment: anti-scratch, anti-fog, antistatic. Individual adjustable temple length and lens inclination.



Art.	Pz./St.	€	EAN
24118	10	17,85-	8 016604 241185

Art. 403

PIÙ EFFICIENZA CON LA NEBULIZZAZIONE ULTRA FINE!

IMÁS EFICIENCIA CON LA NEBULIZACIÓN ULTRA FINA!
MEHR EFFIENZ DURCH ULTRA-FEINE VERNEBELUNG!
MORE EFFICIENCY WITH THE ULTRA-FINE NEBULIZATION!

- IT** Ideale per spazi verdi e giardini, anche di grandi dimensioni. La nebulizzazione ultrafine garantisce maggiore efficacia grazie alla copertura uniforme delle superfici o della vegetazione, riducendo lo spreco d'acqua e la fatica.
- ES** Ideal para espacios verdes y jardines, incluso grandes. La nebulización ultrafina garantiza una mayor eficacia gracias a la cobertura uniforme de superficies o vegetación, reduciendo el desperdicio de agua y esfuerzo.
- DE** Ideal für weitläufigere Grünflächen und Gärten. Die ultra-feine Vernebelung garantiert eine höhere Effizienz durch die gleichmäßige Zerstäubung auf verschiedensten Oberflächen und verringert Wasserverschwendung und Ermüdung.
- EN** Ideal for green areas and gardens, even large ones. The ultra-fine nebulization guarantees more effectiveness, as it allows a uniform coverage of surfaces or vegetation, while reducing water waste and the strain.



Incastro veloce
Fast click in

IT Nebbia Pompa a zaino elettrica 15 L Li-Ion FPM
Copertura ottimale e bagnatura limitata di piante e superfici grazie alla nebulizzazione ultra fine. Innovativo sistema a zaino ergonomico per una migliore distribuzione del carico. Pressione regolabile su due livelli: 3,5 o 7 bar. Getto fino a 9 metri di distanza con lancia in alluminio. Tempo di ricarica della batteria: 2 ore. Completa di tubo flessibile, lancia in fibra di vetro con ugello doppio e lancia in alluminio. Nuova impugnatura, ergonomica e robusta.

ES Nebbia Bomba de mochila eléctrica 15 L Li-Ion FPM
Cobertura óptima y humectación limitada de plantas y superficies gracias a la nebulización ultrafina. Innovador sistema de mochila ergonómica para una mejor distribución de la carga. Presión ajustable a dos niveles: 3,5 o 7 bar. Chorro hasta 9 metros de distancia con lanza de aluminio. Tiempo de carga de la batería: 2 horas. Completa de tubo flexible, lanza en fibra de vidrio con boquilla doble y lanza de aluminio. Nueva empuñadura, ergonómica y robusta.

DE Nebbia Elektrische Rückenspritze 15 L Li-Ion FPM
Optimaler flächendeckender Sprühnebel mit geringer Befeuchtung durch die ultrafein Nebulisierung. Innovatives, ergonomisches Rucksacksystem für eine bessere Gewichtsverteilung. Stufeneinstellung der Leistung von 3,5 oder 7 Bar. Reichweite bis zu 9 Meter mit der Aluminium Lanze. Akku-Ladezeit: 2 Stunden. Komplet mit Schlauch, Handbrause aus Aluminium und Handbrause aus Fiberglas mit Zweifachdüse. Neuer Griff, ergonomisch und robust.

EN Nebbia Electric backpack sprayer 15 L Li-Ion FPM
An optimal coverage is guaranteed while plants and surfaces do not get too wet thanks to the ultra-fine nebulization. Innovative ergonomic backpack system for an optimal distribution of the weight. Two levels of adjustable pressure: 3,5 and 7 bar. Powerful jet spray of up to 9 meters, with aluminium lance. Battery charge time: 2 hours. Complete with tube, aluminium spray lance and fibreglass spray lance with double nozzle. New handle shape, ergonomic and robust.



vedi pag. 312
ver página 312
siehe Seite 312
see on page 312

Art.	lt.	Gr.	Pz./St.	€	EAN
403	15	3.325	2	228,00-	8 016604 004032

Art. 225, 229

SONO LA PIÙ LEGGERA

SOY LA MAS LIGERA
ICH BIN DIE LEICHTESTE
I AM THE LIGHTEST

- IT** La soluzione perfetta per chi cerca maggiore potenza, per trattamenti su piante di dimensioni medio grandi, come alberi da frutto e olivi. **Permettono un getto fino a 7 metri di distanza!**
- ES** La solución perfecta para aquellos que buscan más potencia, para tratamientos en plantas medianas y grandes, como árboles frutales y olivos. **Permiten un chorro de hasta 7 metros de distancia!**
- DE** Die perfekte Lösung für diejenigen, die mehr Leistung brauchen, für Behandlungen an mittleren bis großen Pflanzen wie Obst- und Olivenbäumen. **Mit einer Sprühweite von bis zu 7 Metern!**
- EN** The perfect solution for the hobby farmers that need more power, for treatments of medium-high plants, such as fruit- and olive-trees. **For a jet spray of up to 7 meters distance!**



IT Pompa a zaino elettrica 12 / 15 L Li-Ion
Nuova robusta impugnatura. Con batteria Li-Ion da 12 V / 2,5 Ah ricaricabile. Lancia in alluminio, lancia in fibra di vetro e caricabatterie in dotazione.

ES Bomba de mochila eléctrica 12 / 15 L
Nueva empuñadura robusta. Con batería recargable de iones de litio de 12 V / 2,5 Ah. Lanza en fibra de vidrio, lanza de aluminio y cargador en dotación.

DE Elektrische Rückenspritze 12 / 15 L Li-Ion
Neuen robusten Griff. Mit einer aufladbaren 12 V / 2,5 Ah Batterie. Komplet mit Handbrause aus Aluminium, Handbrause aus Fiberglas und Akku-Ladegerät.

EN Electric backpack sprayer 12 / 15 L Li-Ion
New handle shape. With 12 V / 2,5 Ah rechargeable Li-Ion battery. Complete with aluminium spray lance, fibreglass spray lance and battery charger.



vedi pag. 313
ver página 313
siehe Seite 313
see on page 313

Art.	lt.	Gr.	Pz./St.	€	EAN
225	12	2.850	1	144,00-	8 016604 002250
229	15	2.950	1	160,50-	8 016604 002298

Art. 230, 237, 237, 239, 1239

SONO LA PIÙ LEGGERA

SOY LA MAS LIGERA
ICH BIN DIE LEICHTESTE
I AM THE LIGHTTEST

- IT** La soluzione perfetta per trattamenti che non durano molto a lungo, in orti e su piante da frutto o ornamentali di piccole e medie dimensioni.
Permettono un getto fino a 6 metri di distanza!
- ES** La solución perfecta para tratamientos que no duran mucho tiempo, en huertas y en plantas de fruta o de adorno de tamaño pequeño o medio.
Permiten un chorro de hasta 6 metros de distancia!
- DE** Die ideale Lösung für kurzweilige Behandlungen in Gemüsegärten und an kleinen und mittelgroßen Obst- oder Zierpflanzen.
Mit einer Sprühweite von bis zu 6 Metern!
- EN** The perfect solution for short-time treatments on ornamental plants or small- and medium-sized fruit trees.
For a jet spray of up to 6 meters distance!



LI-ION POWER



2,5 BAR



Incastro veloce
Fast click in

- Pompa elettrica a tracolla 5 L Li-ion**
- Bomba eléctrica bandolera 5 L Li-ion**
- Elektro-Sprühgerät mit Tragriemen 5 L Li-ion**
- Electric sprayer with shoulder strap 5 L Li-ion**

5 LITER MAX. 1,3 l/min 67 cm 210 min 12 VOLT 2,5 Ah vedi pag. 316 ver página 316 siehe Seite 316 see on page 316

Art.	lt.	Gr.	Pz./St.	€	EAN
230	5	2.500	2	96,40-	8 016604 902307



LI-ION POWER



2,5 BAR



Incastro veloce
Fast click in

2x FIBRE GLASS ALU

Set con lancia aggiuntiva (Art. 242/38).
Set con lanza adicional (Art. 242/38).
Set inklusive Zusatz-handbrause (Art. 242/38).
Set includes additional lance (Art. 242/38).

- Pompa a zaino elettrica Li-ion**
- Bomba de mochila eléctrica Li-ion**
- Elektrische Rückenspritze Li-ion**
- Electric backpack sprayer Li-ion**

MAX. 1,3 l/min 67 cm 210 min 12 VOLT 2,5 Ah vedi pag. 317 ver página 317 siehe Seite 317 see on page 317

Art.	lt.	Gr.	Pz./St.	€	EAN
237	8	2.700	2	119,00-	8 016604 002373
238	10	2.780	2	127,50-	8 016604 002380
239	12	2.870	2	131,00-	8 016604 002397



LI-ION POWER



2,5 BAR



- Pompa a zaino elettrica 12 L Li-ion Trolley**
Come Art. 239. Con trolley

2x FIBRE ALU

Set con lancia aggiuntiva (Art. 242/38).
Set con lanza adicional (Art. 242/38).
Set inklusive Zusatz-handbrause (Art. 242/38).
Set includes additional lance (Art. 242/38).

- Bomba de mochila eléctrica 12 L Li-ion Trolley**
Como Art. 239. Con trolley

- Elektrische Rückenspritze 12 L Li-ion Trolley**
Wie Art. 239. Mit Trolley

- Electric backpack sprayer 12 L Li-ion Trolley**
As Art. 239. Complete with trolley

12 LITER MAX. 1,3 l/min 67 cm 210 min 12 VOLT 2,5 Ah vedi pag. 317 ver página 317 siehe Seite 317 see on page 317

Art.	lt.	Gr.	Pz./St.	€	EAN
1239	12	7.640	2	184,50-	8 016604 012396

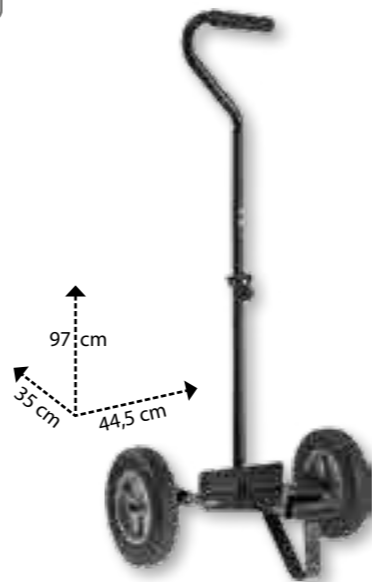

- Trolley** (4.770 g)
- Trolley** (4.770 g)
- Trolley** (4.770 g)
- Trolley** (4.770 g)

per /para /für /for Art. 1239, 235, 236, 237, 238, 239, 225, 226, 227, 229, 403

vedi pag. 318 ver página 318 siehe Seite 318 see on page 318

Art.	cm	Pz./St.	€	EAN
1239/1	44,5 x 35 x h 97	1	70,20-	8 016604 012399



Sistema a zaino ergonomico.
Sistema de mochila ergonómico.
Ergonomisches Rucksacksystem.
Ergonomic backpack system.

- Bastino per pompa da 12 L, 15 L, 20 L**
Adatto anche per altri modelli di pompa a zaino elettrica con serbatoio della stessa forma.

- Portador para bomba de 12 L, 15 L, 20 L**
Adecuado también para otros modelos de bomba de mochila eléctrica con tanque de la misma forma.

- Schultergurt für Rückenspritze zu 12 L, 15 L, 20 L**
Auch für andere Modelle der elektrischen Rückenspritze mit gleichförmigem Tank geeignet.

- Shoulder harness for 12 L, 15 L, 20 L sprayer**
Also suitable for other models of electric backpack sprayers with alike-shaped tank.

423*: per/para/für/for Art. 225, 226, 239, 235
424**: per/para/für/for Art. 227, 229, 236, 403
425***: per/para/für/for Art. 228

* fino ad esaurimento
* hasta agotamiento
* solange der Vorrat reicht
* While supplies last

Art.	cm	Gr.	Pz./St.	€	EAN
423*	30 x h 39	530	12	35,80-	8 016604 004230
424**	30 x h 42,5	544	12	36,85-	8 016604 004247
425***	30 x h 46	563	12	37,50-	8 016604 004254



- Campana diserbo**
Per pompe elettriche da 2,5 bar.

- Campana escardo**
Para bombas eléctricas hasta 2,5 bar.

- Sprühkegel**
Für elektrische Pumpen bis zu 2,5 Bar.

- Herbicide hood**
For electric sprayers up to 2,5 bar.

per/para/für/for Art. 237/14, 242/29, 242/32, 242/36, 242/37, 242/39, 242/40, G-252, G-259

Art.	cm	Gr.	Pz./St.	€	EAN
237/13			12	9,10-	8 016604 502385

Art. 2621, 401, 402

FACILE E LEGGERA!

FÁCIL Y LIGERA
EINFACH LEICHT!
EASY AND LIGHTWEIGHT!

- IT** Leggere ed efficienti, alleate nel giardino, nell'orto e anche sul balcone. Ideali per trattamenti sulle orticole e piante ornamentali. La batteria non è estraibile.
- ES** Ligeras y eficientes, aliadas en el jardín, en la huerta e incluso en el balcón. Ideales para tratamientos en plantas horticolas y ornamentales. La batería no es extraíble.
- DE** Leicht und effizient. Deine Verbündete im Garten, Gemüsegarten und sogar auf dem Balkon. Ideal zur Behandlung von Garten- und Zierpflanzen. Der Akku ist nicht abnehmbar.
- EN** Super lightweight and efficient, these sprayers are true allies in the garden as well as on the balcony! Ideal for treatments in the vegetable garden and on ornamental plants. The battery cannot be removed.



Thalia Pompa elettrica 2 L Li-Ion
Completa di cavo USB tipo C per la ricarica della batteria.

Thalia Bomba eléctrica 2 L Li-Ion
Completa con cable USB tipo C para cargar la batería.

Thalia Elektro-Sprühgerät 2 L Li-Ion
Komplett mit USB-Kabel Typ C zum Aufladen der Batterie.

Thalia Electric sprayer 2 L Li-Ion
Complete with C-type USB charging cable.



vedi pag. 319
ver página 319
siehe Seite 319
see on page 319

Art.	lt.	Gr.	Pz./St.	€	EAN
2621	2	585	8	30,15-	8 016604 026218

Espositore Thalia Pompa elettrica 2 L Li-Ion
Expositor Thalia Bomba eléctrica 2 L Li-Ion
Display Thalia Elektro-Sprühgerät 2 L Li-Ion
Display Thalia Electric sprayer 2 L Li-Ion

Art.	lt.	Gr.	Pz./St.	€	EAN
22621	18	30,15-	8	016604 226212	



Thalia Pompa elettrica a tracolla 4 L Li-Ion
Thalia Bomba eléctrica bandolera 4 L Li-Ion
Thalia Elektro-Sprühgerät mit Trageriemem 4 L Li-Ion
Thalia Electric sprayer with shoulder strap 4 L Li-Ion



vedi pag. 320
ver página 320
siehe Seite 320
see on page 320

Art.	lt.	Gr.	Pz./St.	€	EAN
401	4	1.450	2	62,70-	8 016604 004018

Thalia Pompa elettrica a tracolla 6 L Li-Ion
Thalia Bomba eléctrica bandolera 6 L Li-Ion
Thalia Elektro-Sprühgerät mit Trageriemem 6 L Li-Ion
Thalia Electric sprayer with shoulder strap 6 L Li-Ion



vedi pag. 320
ver página 320
siehe Seite 320
see on page 320

Art.	lt.	Gr.	Pz./St.	€	EAN
402	6	1.655	2	66,70-	8 016604 004025

Art. 247, 1247

EFFICIENZA E TRADIZIONE!

EFICACIA Y TRADICIÓN!
EFFIENZ UND TRADITION!
EFFICIENCY AND TRADITION!

- IT** Una soluzione classica perfetta per l'applicazione di agenti liquidi di protezione su piante di medie dimensioni, in giardini familiari e vigneti, e per fertilizzare.
- ES** Una solución clásica ideal para la aplicación de sustancias líquidas de protección en plantas de tamaño medio, en jardines familiares y viñedos, y para fertilizar.
- DE** Eine klassische Lösung, die sich perfekt zum Verteilen von flüssigen Pflanzenschutzmitteln auf mittelgroße Pflanzen, in Familiengärten und Weinbergen sowie zum Düngen eignet.
- EN** The perfect classic solution for treatments to medium sized plants, in family gardens and vineyards, and to fertilize.



Set con lancia aggiuntiva (Art. 242/38).
Set con lanza adicional (Art. 242/38).
Set inklusive Zusatz-handbrause (Art. 242/38).
Set includes additional lance (Art. 242/38).

Pompa a zaino elettrica 15 L Li-Ion
Pressione regolabile da 1 a 5 bar.

Bomba de mochila eléctrica 15 L Li-Ion
Presión ajustable de 1 a 5 bar.

Elektrische Rücken-Spritze 15 L Li-Ion
Druck einstellbar von 1 bis 5 bar.

Electric backpack sprayer 15 L Li-Ion
Adjustable pressure from 1 to 5 bar.



vedi pag. 321
ver página 321
siehe Seite 321
see on page 321

Art.	lt.	Gr.	Pz./St.	€	EAN
247	15	4.264	2	203,00-	8 016604 002472



Pompa a zaino elettrica 15 L Li-Ion Trolley
Come Art. 247 con tubo da 3 metri. Con trolley

Bomba de mochila eléctrica 15 L Li-Ion Trolley
Como Art. 247 con tubo de 3 metros. Con trolley

Elektrische Rückenspritze 15 L Li-Ion Trolley
Wie Art. 247 mit 3-Meter-Schlauch. Mit Trolley

Electric backpack sprayer 15 L Li-Ion Trolley
As Art. 247 with 3 meter tube. Complete with trolley



vedi pag. 321
ver página 321
siehe Seite 321
see on page 321

Art.	lt.	Gr.	Pz./St.	€	EAN
1247	15	11.264	1	246,00-	8 016604 012471



Trolley (7.000 g)
Trolley (7.000 g)
Trolley (7.000 g)
Trolley (7.000 g)

per /para /für /for Art. 1247, 247, 242

vedi pag. 318
ver página 318
siehe Seite 318
see on page 318

Art.	cm	Pz./St.	€	EAN
1247/1	54 x 45 x h 99	2	65,90-	8 016604 912474



Pompa a carriola a batteria 40 L
Tubo da 30 metri con pratico avvolgitubo.
Regolatore di pressione da 1 a 10 bar.

Bomba de carretilla con batería 40 L
Tubo de 30 metros con práctico enrollador.
Regulador de presión de 1 a 10 bar.

Schubkarrenpumpe mit Batterie 40 L
30 Meter langer Schlauch mit praktischer Schlauchtrommel.
Druckregler von 1 bis 10 bar.

Wheelbarrow battery pump 40 L
30 meter tube with handy hose reel.
Pressure regulator from 1 to 10 bar.



vedi pag. 322
ver página 322
siehe Seite 322
see on page 322

Art.	lt.	Kg.	Pz./St.	€	EAN
301	40	56	1	642,00-	8 016604 003011



Pompa a carriola a batteria 60 L
Tubo da 30 metri con pratico avvolgitubo.
Regolatore di pressione da 1 a 10 bar.

Bomba de carretilla con batería 60 L
Tubo de 30 metros con práctico enrollador.
Regulador de presión de 1 a 10 bar.

Schubkarrenpumpe mit Batterie 60 L
30 Meter langer Schlauch mit praktischer Schlauchtrommel.
Druckregler von 1 bis 10 bar.

Wheelbarrow battery pump 60 L
30 meter tube with handy hose reel.
Pressure regulator from 1 to 10 bar.



vedi pag. 322
ver página 322
siehe Seite 322
see on page 322

Art.	lt.	Kg.	Pz./St.	€	EAN
302	60	57	1	684,00-	8 016604 003028



Pompa a carriola a batteria 80 L
Tubo da 50 metri con pratico avvolgitubo. Completa di gancio traino e barra d'irrigazione per tappeti erbosi. Regolatore di pressione da 1 a 10 bar.

Bomba de carretilla con batería 80 L
Tubo de 50 metros con práctico enrollador. Completa con enganche de remolque y barra de riego para céspedes. Regulador de presión de 1 a 10 bar.

Schubkarrenpumpe mit Batterie 80 L
50 Meter langer Schlauch mit praktischer Schlauchtrommel. Mit Anschlussmöglichkeit an Anhängerkupplung von kleinen Traktoren. Druckregler von 1 bis 10 bar.

Wheelbarrow battery pump 80 L
50 meter tube with handy hose reel. Complete with swinging drawbar and irrigation bar for grass. Pressure regulator from 1 to 10 bar.



vedi pag. 324
ver página 324
siehe Seite 324
see on page 324

Art.	lt.	Kg.	Pz./St.	€	EAN
303	80	62	1	838,00-	8 016604 003035

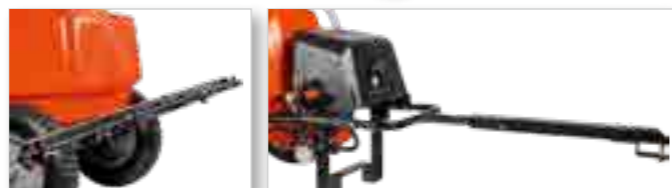

Pompa a carriola a batteria 100 L
Tubo da 50 metri con pratico avvolgitubo. Completa di gancio traino e barra d'irrigazione per tappeti erbosi. Regolatore di pressione da 1 a 10 bar.

Bomba de carretilla con batería 100 L
Tubo de 50 metros con práctico enrollador. Completa con enganche de remolque y barra de riego para céspedes. Regulador de presión de 1 a 10 bar.

Schubkarrenpumpe mit Batterie 100 L
50 Meter langer Schlauch mit praktischer Schlauchtrommel. Mit Anschlussmöglichkeit an Anhängerkupplung von kleinen Traktoren. Druckregler von 1 bis 10 bar.

Wheelbarrow battery pump 100 L
50 meter tube with handy hose reel. Complete with swinging drawbar and irrigation bar for grass. Pressure regulator from 1 to 10 bar.



Dati tecnici - Datos técnicos - Technische Daten - Technical data			
Dimensioni Medidas Abmessungen Dimensions	165 x 76,5 x h 86 cm	Tempo di ricarica Tiempo de carga Ladezeit Recharging time	12 h
Peso Peso Gewicht Weight	63 kg	Flusso d'acqua Caudal de agua Wasserfluss Water flow	1,5 - 6 l/min
Batteria Batería Batterie Battery	12 V / 36 Ah	Potenza del motore Potencia del motor Motorleistung Motor power	100 W



vedi pag. 324
ver página 324
siehe Seite 324
see on page 324



Art.	lt.	Kg.	Pz./St.	€	EAN
304	100	63	1	876,00-	8 016604 003042



Barra d'irrigazione per tappeti erbosi
Lunghezza regolabile da 1,50 fino a 2,50 metri. Barra di supporto in acciaio con astine in fibra di vetro e ugelli in plastica per getto a ventaglio. Larghezza dello spruzzo fino a 5 metri.

Barra de irrigación para céspedes
Longitud ajustable de 1,50 hasta 2,50 metros. Barra de soporte de acero con varillas de fibra de vidrio y boquillas de plástico para chorro en forma de abanico. Ancho de pulverización hasta 5 metros.

Sprühlanze für Grünflächen
Regulierbare Breite von 1,50 bis 2,5 Meter. Stahlstützstange mit Fiberglas-Röhrchen und Kunststoffdüsen für Fächerstrahl. Sprühkegelbreite bis zu 5 Meter.

Irrigation bar for grass
Adjustable length from 1,5 to 2,5 meters. Steel support bar with fiberglass rods and plastic nozzles with fan-shaped jet. Spraying width up to 5 meters.

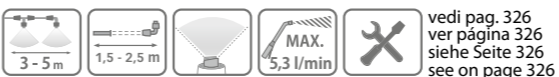

vedi pag. 326
ver página 326
siehe Seite 326
see on page 326

Art.	m	Gr.	Pz./St.	€	EAN
305	1,5-2,5	2700	2	80,20-	8 016604 003059



Per/para/für/for Art. 301, 302, 303*, 304*.
*già incluso nella fornitura
*ya incluido en el suministro
*bereits im Lieferumfang enthalten
*included in the supply

A man with grey hair and a mustache, wearing a blue and white plaid shirt, is shown in profile, focused on pruning a young tree branch. He is using a pair of professional pruning shears. The background is a soft-focus outdoor setting with green foliage and a hint of a sunset or sunrise sky. In the top right corner, there is a white box containing the 'stocker' logo and the website 'www.stockergarden.com'. Below this is a blue and green graphic element. In the bottom right, there is a dark blue banner with white text and a small icon of a document with the number 80.

stocker

www.stockergarden.com

FORBICI PROFESSIONALI

TIJERAS PROFESIONALES
PROFI-SCHEREN
PROFESSIONAL PRUNING SHEARS

Art. 376

80

- Forbice Profi Amboss 19**
- Tijera Profi de yunque 19**
- Schere Profi Amboss 19**
- Profi Anvil shears 19**



Art.	cm	Gr.	Pz./St.	€	EAN
367	19	200	12	26,60-	8 016604 003677

- Forbice Profi Amboss 21**
- Tijera Profi de yunque 21**
- Schere Profi Amboss 21**
- Profi Anvil shears 21**



Art.	cm	Gr.	Pz./St.	€	EAN
335	21	210	12	27,40-	8 016604 003356

- Forbice Profi Bypass 21**
- Tijera Profi Bypass 21**
- Schere Profi Bypass 21**
- Profi Bypass shears 21**



Art.	cm	Gr.	Pz./St.	€	EAN
342	21	240	12	29,20-	8 016604 003424

- Forbice Profi Bypass 22**
- Tijera Profi Bypass 22**
- Schere Profi Bypass 22**
- Profi Bypass shears 22**



Art.	cm	Gr.	Pz./St.	€	EAN
343	22	250	12	29,20-	8 016604 003431

- Espositore per Forbice Profi 22**
(12 pz x Art. 343)

- Expositor para Tijera Profi 22**
(12 pzs x art. 343)

- Display für Schere Profi 22**
(12 St. x Art. 343)

- Display for Profi shears 22**
(12 pcs x Art. 343)



Art.	cm	Gr.	Pz./St.	€	EAN
1343	22	300	12	29,20-	8 016604 013430

- Forbice Profi Bypass 20**
- Tijera Profi Bypass 20**
- Profi Bypass Schere 20**
- Profi Bypass shears 20**



Art.	cm	Gr.	Pz./St.	€	EAN
350	20	230	12	28,50-	8 016604 003509

- Forbice Profi Bypass 23**
- Tijera Profi Bypass 23**
- Schere Profi Bypass 23**
- Profi Bypass shears 23**



Art.	cm	Gr.	Pz./St.	€	EAN
352	23	308	12	30,20-	8 016604 003523

- Forbice Profi Bypass 22**
Con manico girevole

- Tijera Profi Bypass 22**
Con mango giratorio

- Schere Profi Bypass 22**
Mit Rollgriff

- Profi Bypass shears 22**
With revolving handle

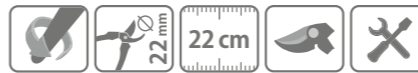

Art.	cm	Gr.	Pz./St.	€	EAN
368	22	300	12	35,70-	8 016604 003684

- Forbice da potatura 21**
- Tijera de poda 21**
- Baumschere 21**
- Pruning shears 21**



Art.	cm	Gr.	Pz./St.	€	EAN
382	21	302	6	18,00-	8 016604 003820

- Forbice da potatura 19**
- Tijera de poda 19**
- Baumschere 19**
- Pruning shears 19**



Art.	cm	Gr.	Pz./St.	€	EAN
384	19	242	6	17,50-	8 016604 003844

- Forbice da potatura 23**
- Tijera de poda 23**
- Baumschere 23**
- Pruning shears 23**



Art.	cm	Gr.	Pz./St.	€	EAN
386	23	304	6	19,60-	8 016604 003868





- Forbice Ergo Light 21
- Tijera Ergo Light 21
- Schere Ergo Light 21
- Ergo Light pruning shears 21



Art.	cm	Gr.	Pz./St.	€	EAN
376	21	240	6	47,40-	8 016604 003769



- Forbice Classic Light 21
- Tijera Classic Light 21
- Schere Classic Light 21
- Classic Light pruning shears 21



Art.	cm	Gr.	Pz./St.	€	EAN
377	21	240	6	44,95-	8 016604 003776



- Forbice Ergo Light 21
- Tijera Ergo Light 21
- Schere Ergo Light 21
- Ergo Light pruning shears 21



Art.	cm	Gr.	Pz./St.	€	EAN
378	21	240	6	47,40-	8 016604 003783



- Forbice Classic Light 21
- Tijera Classic Light 21
- Schere Classic Light 21
- Classic Light pruning shears 21



Art.	cm	Gr.	Pz./St.	€	EAN
379	21	240	6	44,95-	8 016604 003790



- Forbice a doppio taglio 19
- Tijera de doble corte 19
- Zweischneidige Schere 19
- Double-cut pruning shears 19



Art.	cm	Gr.	Pz./St.	€	EAN
383	19	236	6	40,65-	8 016604 003837



- Forbice a doppio taglio 21
- Tijera de doble corte 21
- Zweischneidige Schere 21
- Double-cut pruning shears 21



Art.	cm	Gr.	Pz./St.	€	EAN
381	21	342	6	45,30-	8 016604 003813



- Forbice a doppio taglio 21
- Tijera de doble corte 21
- Zweischneidige Schere 21
- Double-cut pruning shears 21



Art.	cm	Gr.	Pz./St.	€	EAN
380	21	342	6	42,65-	8 016604 003806



- Espositore da banco per forbici
- Minimo: 12 pz / Massimo: 2 modelli
- Articoli a scelta: 376, 377, 378, 379, 381, 380

- Expositor de mostrador para tijeras
- Mínimo: 12 pzs / Máximo: 2 modelos
- Artículos a elegir: 376, 377, 378, 379, 381, 380

- Verkaufsständer für Scheren
- Minimum: 12 St. / Maximum: 2 Modelle
- Artikel zur Auswahl: 376, 377, 378, 379, 381, 380

- Table display for shears
- Minimum: 12 pcs / Maximum: 2 types
- Available model types: 376, 377, 378, 379, 381, 380

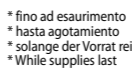

Art.	cm	Pz./St.	€	EAN
64	22 x 25 x h 39,5			8 016604 000645



AFFILATURA ASIMMETRICA CENTRALE
Afilado asimétrico central
ZENTRALER ASYMMETRISCHER SCHLIFF
Central asymmetric grinding



- Art. 376, 377, 380, 381, 383**
- La lama piatta permette un taglio preciso e vicino al tronco.
- La hoja plana es perfecta para un corte preciso y cerca del tronco
- Die flache Klinge ermöglicht einen präzisen Schnitt direkt am Stamm.
- The flat blade assures a precise and close cut to the trunk.

AFFILATURA SIMMETRICA CENTRALE
Afilado simétrico central
ZENTRALER SYMMETRISCHER SCHLIFF
Central symmetric grinding

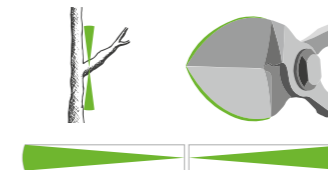

- Art. 378, 379**
- L'affilatura centrale su entrambi i lati riduce lo sforzo nel taglio.
- El afilado central en ambos lados reduce el esfuerzo en el corte.
- Der beidseitige Schliff verringert den Kraftaufwand beim Schneiden.
- The central grinding on both sides of the blades reduces the strain of the cut.

LAMA DECENTRATA
Hoja descentrada
DEZENTRIERTE KLINGE
Decentered blade

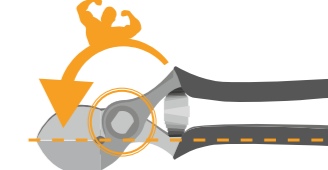

- Art. 381**
- La lama decentrata e piatta riduce lo sforzo del lavoro e permette un taglio vicino al tronco.
- La hoja descentrada y plana reduce el esfuerzo del trabajo y permite un corte cerca del tronco.
- Die dezentrierte, flache Klinge verringert den Kraftaufwand und ermöglicht einen präzisen Schnitt am Stamm.
- The flat and decentered blade reduces the effort and assures a close cut to the trunk.

- Forbice giardino Bypass 19
- Tijera jardín Bypass 19
- Gartenschere Bypass 19
- Garden Bypass shears 19



Art.	cm	Gr.	Pz./St.	€	EAN
322	19	176	12	21,40-	8 016604 003226

- Forbice giardino Bypass 19,5
- Tijera jardín Bypass 19,5
- Gartenschere Bypass 19,5
- Garden Bypass shears 19,5



Art.	cm	Gr.	Pz./St.	€	EAN
323	19,5	184	12	21,80-	8 016604 003233

- Starter Kit Potatura

Kit di base per la potatura formato da seghetto pieghevole con lama da 18 cm (Art. 1419) e forbici bypass super leggere (Art. 323).

- Starter Kit Poda

Kit base para la poda formado por un serrucho plegable con hoja de 18 cm (Art. 1419) y tijera bypass (Art. 323) super ligeras.

- Starter Kit Baumschnitt

Basis-Kit für den Baumschnitt. Mit Klappsäge 18 cm Klinge (Art. 1419) und superleichter Bypass-Gartenschere (Art. 323).

- Pruning starter kit

Pruning starter kit with folding saw 18 cm blade (Art. 1419) and lightweight bypass pruning shears (Art. 323).



Art.	cm	Gr.	Pz./St.	€	EAN
1420	18/19,5	197/184	6	37,20-	8 016604 014208

- Forbice giardino Bypass 19
- Tijera jardín Bypass 19
- Bypass Gartenschere 19
- Garden Bypass shears 19



Art.	cm	Gr.	Pz./St.	€	EAN
362	19	178	12	21,40-	8 016604 003622

- Forbice giardino Bypass 19,5
- Tijera jardín Bypass 19,5
- Bypass Gartenschere 19,5
- Garden Bypass shears 19,5



Art.	cm	Gr.	Pz./St.	€	EAN
363	19,5	192	12	21,80-	8 016604 003639

- Forbice giardino Amboss 20
- Tijera jardín de yunque 20
- Amboss Gartenschere 20
- Garden Anvil shears 20



Art.	cm	Gr.	Pz./St.	€	EAN
364	20	180	12	23,80-	8 016604 003646

- Forbice universale giardino 21
- Tijera universal jardín 21
- Universal Gartenschere 21
- Universal garden shears 21



Art.	cm	Gr.	Pz./St.	€	EAN
344	21	266	12	15,70-	8 016604 472053

- Forbice universale giardino 20
- Tijera universal jardín 20
- Universalgartenschere 20
- Universal garden shears 20



Art.	cm	Gr.	Pz./St.	€	EAN
371	20	172	12	12,00-	8 016604 003714

- Forbice anello vendemmia inox
- Tijera anillo vendimia inox
- Ringschere Weinlese inox
- Ring harvest shears inox



* fino ad esaurimento
* hasta agotamiento
* solange der Vorrat reicht
* While supplies last

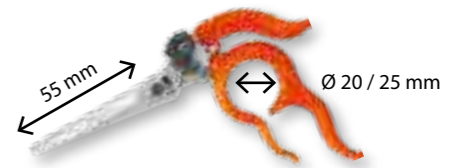

Art.	Ø mm	mm	Gr.	Pz./St.	€	EAN
34620	20	55	35	12	10,50-	8 016604 346200
34625	25	55	35	12	10,50-	8 016604 346255

- Forbice anello vendemmia inox
- Tijera anillo vendimia inox
- Ringschere Weinlese inox
- Ring harvest shears inox



* fino ad esaurimento
* hasta agotamiento
* solange der Vorrat reicht
* While supplies last

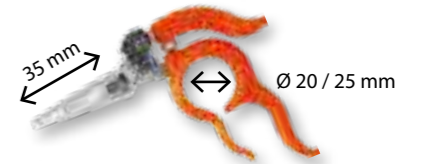

Art.	Ø mm	mm	Gr.	Pz./St.	€	EAN
34520	20	35	30	12	10,00-	8 016604 345203
34525	25	35	32	12	10,00-	8 016604 345258

- Forbice vendemmia curva 18
- Tijera vendimia curva 18
- Gebogene Weinleseschere 18
- Harvesting curved shears 18



Art.	cm	Gr.	Pz./St.	€	EAN
392	18	100	12	11,00-	8 016604 003929

- Forbice vendemmia a punta 18
- Tijera vendimia de punta 18
- Spitzschere Weinlese 18
- Harvesting pointed shears 18



Art.	cm	Gr.	Pz./St.	€	EAN
393	18	90	12	11,00-	8 016604 003936

- Forbice agrumi**
- Tijera cítricos**
- Zitrussschere**
- Citrus fruits shears**



Art.	cm	Gr.	Pz./St.	€	EAN
349	10	40	12	12,00-	8 016604 003493

- Forbice agrumi**
- Tijera cítricos**
- Zitrussschere**
- Citrus fruits shears**



* fino ad esaurimento
* hasta agotamiento
* solange der Vorrat reicht
* While supplies last



Art.	cm	Gr.	Pz./St.	€	EAN
339	10	56	12	13,40-	8 016604 003394

- Forbice agrumi**
- Tijera cítricos**
- Zitrussschere**
- Citrus fruits shears**



Art.	cm	Gr.	Pz./St.	€	EAN
346	16,5	110	12	9,20-	8 016604 003462

- Forbice con lama corta 16,5**
- Tijera con hoja corta 16,5**
- Schere mit kurzer Klinge 16,5**
- Short blade shears 16,5**

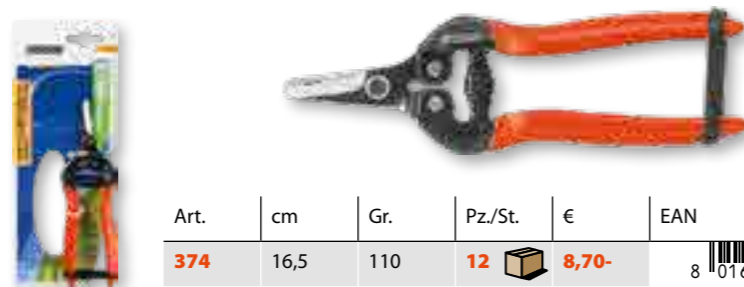

Art.	cm	Gr.	Pz./St.	€	EAN
374	16,5	110	12	8,70-	8 016604 003745

FACEBOOK: + 68.000 APPASSIONATI

Una community che condivide opinioni:

Ogni settimana nuovi contenuti, suggerimenti e consigli per una community che cresce ogni giorno.

Conosci meglio il consumatore finale.

www.facebook.com/Stockergarden

FACEBOOK: + 68,000 FOLLOWERS

A community that shares opinions:

Every week new content, tips and advice for a community that grows every day.

Get to know the consumer better.



- Forbice speciale vendemmia 19**
- Tijera especial vendimia 19**
- Spezial-Weinleseschere 19**
- Special harvest shears 19**



Art.	cm	Gr.	Pz./St.	€	EAN
345	19	110	12	8,80-	8 016604 407222

- Espositore per Forbice Speciale**
(24 pz x Art. 345)

- Expositor para Tijera Especial**
(24 pzs x art. 345)

- Display für Schere spezial**
(24 St. x Art. 345)

- Display for special shears**
(24 pcs x Art. 345)



Art.	cm	Gr.	Pz./St.	€	EAN
1345	19	108	24	8,70-	8 016604 401345

- Forbice inox 19**
- Tijera inoxidable 19**
- Schere Inox 19**
- Inox shears 19**



Art.	cm	Gr.	Pz./St.	€	EAN
332	19	125	12	9,30-	8 016604 400325

- Forbice inox a punta 19**
- Tijera inoxidable de punta 19**
- Spitzschere Inox 19**
- Inox pointed shears 19**



Art.	cm	Gr.	Pz./St.	€	EAN
333	19	120	12	9,30-	8 016604 400332

- Forbice inox a punta 14**
- Tijera inoxidable de punta 14**
- Spitzschere Inox 14**
- Inox pointed shears 14**



Art.	cm	Gr.	Pz./St.	€	EAN
334	14	55	12	9,10-	8 016604 400339

- Forbice milleusi SNIP**
- Tijera multiusos SNIP**
- Mehrzweckschere SNIP**
- All purpose shears SNIP**



Art.	cm	Gr.	Pz./St.	€	EAN
348	18	140	12	9,20-	8 016604 400348

- ☑ **Forbice milleusi SNAP**
- ☑ **Tijera multiusos SNAP**
- ☑ **Mehrweckschere SNAP**
- ☑ **All purpose shears SNAP**



Art.	cm	Gr.	Pz./St.	€	EAN
347	18	90	12	6,50-	8 016604 003479

- ☑ **Espositore per Forbice SNAP milleusi**
(24 pz x Art. 347)
- ☑ **Expositor para Tijera SNAP multiusos**
(24 pzs x art. 347)
- ☑ **Display für Mehrweckschere SNAP**
(24 St. x Art. 347)
- ☑ **Display for all purpose shears SNAP**
(24 pcs x Art. 347)



Art.	cm	Gr.	Pz./St.	€	EAN
1347	18	104	24	6,50-	8 016604 013478

- ☑ **Forbice per fiori 17**
- ☑ **Tijera para flores 17**
- ☑ **Blumenschere 17**
- ☑ **Flower shears 17**



Art.	cm	Gr.	Pz./St.	€	EAN
358	17	90	12	6,80-	8 016604 003585

- ☑ **Forbice per fiorista 17**
- ☑ **Tijera para florista 17**
- ☑ **Floristenschere 17**
- ☑ **Florist shears 17**



Art.	cm	Gr.	Pz./St.	€	EAN
933	17	63	12	8,80-	8 016604 009334

- ☑ **Forbice per fiorista 19,5**
- ☑ **Tijera para florista 19,5**
- ☑ **Floristenschere 19,5**
- ☑ **Florist shears 19,5**



Art.	cm	Gr.	Pz./St.	€	EAN
934	19,5	68	12	9,80-	8 016604 009341

YOUTUBE: + 2,2 MILIONI VISUALIZZAZIONI

Non vendiamo solo prodotti, ma creiamo contenuti per migliorarne l'utilizzo!
Un valore aggiunto da far conoscere al consumatore finale!

YOUTUBE: + 2.2 MILLION VIEWS

We don't just sell products, but we create content to improve their use!
An added value the end consumer should know about!



- ☑ **Forbice a cricchetto 18**
- ☑ **Tijera de carraca 18**
- ☑ **Ratschenschere 18**
- ☑ **Ratchet pruning shears 18**



Art.	cm	Gr.	Pz./St.	€	EAN
7244	18	170	12	19,10-	8 016604 072444

- ☑ **Forbice a cricchetto 17**
- ☑ **Tijera de carraca 17**
- ☑ **Ratschenschere 17**
- ☑ **Ratchet pruning shears 17**



Art.	cm	Gr.	Pz./St.	€	EAN
7246	17	120	12	14,10-	8 016604 072468

- ☑ **Troncarami telescopico a cricchetto**
- ☑ **Cortarramas de carraca telescópico**
- ☑ **Ratschen-Astscherer teleskopisch**
- ☑ **Telescopic ratchet lopper**



Art.	cm	Gr.	Pz./St.	€	EAN
7242	75-100	1600	6	67,10-	8 016604 072420



- ☑ **Affilalame combi**
Con acciaio speciale da una parte e ceramica dall'altra.

- ☑ **Afilador combi**
Con acero especial en una cara y cerámica en la otra.

- ☑ **Messerschärfer Kombi**
Mit Schärfereinsatz in Edelstahl auf einer Seite und Abzieheinsatz in Keramik auf der anderen Seite.

- ☑ **Sharpening tool combi**
Special Inox steel on one side and ceramic on the other for perfectly sharpened shears and knives.



Art.	cm	Gr.	Pz./St.	€	EAN
9080	13,5	20	12	13,70-	8 016604 090806

- ☑ **Pietra corindone**
- ☑ **Piedra corindón**
- ☑ **Schleifstein**
- ☑ **Sharpening stone**



Art.	mm	Gr.	Pz./St.	€	EAN
9050	13 x 25 x 100	70	12	6,40-	8 016604 090509

- ☑ **Fodero in cuoio**
Con clips
- ☑ **Funda de cuero**
Con clips
- ☑ **Scherentasche aus Leder**
Mit Clips
- ☑ **Leather sheath**
With clips



Art.	cm	Gr.	Pz./St.	€	EAN
417	28	151	8	15,50-	8 016604 004179

- ☑ **Fodero in cuoio**
- ☑ **Funda de cuero**
- ☑ **Scherentasche aus Leder**
- ☑ **Leather sheath**



Art.	cm	Gr.	Pz./St.	€	EAN
416	28	148	8	11,80-	8 016604 004162

- ☑ **Porta forbici e seghetto**
- ☑ **Funda para tijeras y serrucho**
- ☑ **Scheren- und Sägentasche**
- ☑ **Sheath for shears and saw**



Art.	cm	Gr.	Pz./St.	€	EAN
418	29	113	12	12,00-	8 016604 004186

- ☑ **Fodero per forbici elettriche**
In nylon, con rivestimento interno in PVC.
- ☑ **Funda para tijeras eléctricas**
De nylon, con revestimiento interno de PVC.
- ☑ **Tasche für elektrische Baumscheren**
Aus Nylon, mit PVC verstärkter Innenseite.
- ☑ **Sheath for electric shears**
Made of nylon, with internal PVC lining that.



Art.	cm	Gr.	Pz./St.	€	EAN
426	30	265	6	14,25-	8 016604 004261
429	34	284	6	15,40-	8 016604 004292



- ☑ **Cintura porta attrezzi**
Lunghezza cintura da 87 a 124 cm.
- ☑ **Correa cuelga herramientas**
Longitud correa de 87 a 124 cm.
- ☑ **Werkzeuggürtel**
Gürtellänge von 87 bis 124 cm.



- ☑ **Garden tools belt**
Belt length from 87 to 124 cm.



Art.	cm	Gr.	Pz./St.	€	EAN
491	27 x 26,5	156	12	13,70-	8 016604 004919

- ☑ **Cintura porta attrezzi piccola**
Lunghezza cintura da 87 a 124 cm.
- ☑ **Correa cuelga herramientas pequeña**
Longitud correa de 87 a 124 cm.
- ☑ **Werkzeuggürtel klein**
Gürtellänge von 87 bis 124 cm.



- ☑ **Garden tools belt small**
Belt length from 87 to 124 cm.



Art.	cm	Gr.	Pz./St.	€	EAN
492	18 x 24,5	130	12	12,10-	8 016604 004926

- ☑ **Fodero in nylon per legacci**
- ☑ **Funda de nylon para ataduras**
- ☑ **Nylontasche für Bindematerialien**
- ☑ **Nylon pouch bag**

Art.	cm	Gr.	Pz./St.	€	EAN
422	18 x 12 x h 21	178	6	15,80-	8 016604 004223



- ☑ **Fodero in cuoio per legacci**
- ☑ **Funda de cuero para ataduras**
- ☑ **Ledertasche für Bindematerialien**
- ☑ **Leather pouch bag**

Art.	cm	Gr.	Pz./St.	€	EAN
421	21 x 13,5 x h 22	273	4	25,40-	8 016604 004216



- ☑ **Fodero in nylon e pvc per legacci**
Maggiore comodità grazie agli elastici regolabili per il fissaggio alla gamba.
Con zip di chiusura.

- ☑ **Funda de nylon y pvc para ataduras**
Mayor comodidad gracias a los elásticos ajustables para la fijación a la pierna.
Con cremallera de cierre.

- ☑ **Tasche aus Nylon und Pvc für Bindematerialien**
Elastische Bänder zum Anbringen der Tasche am Bein für mehr Stabilität.
Mit Reißverschluss.

- ☑ **Nylon and pvc pouch bag**
The adjustable elastics allow to fasten it to the leg for advanced comfort.
With zip closure.

Art.	cm	Gr.	Pz./St.	€	EAN
428	18 x 16 x h 20	330	6	16,40-	8 016604 004285



- ☑ **Ordinex Zaino per attrezzi di potatura**
In PVC: idrorepellente e facile da pulire. Spallacci imbottiti e regolabili.

- ☑ **Ordinex Mochila para herramientas de poda**
De PVC: repelente al agua y fácil de limpiar.
Correas para los hombros acolchadas y ajustables.

- ☑ **Ordinex Rucksack für Baumschnittgeräte**
Aus PVC: wasserabweisend und leicht zu reinigen.
Gefütterte und regulierbare Schulterriemen.

- ☑ **Ordinex Backpack for pruning tools**
PVC material: repellent and easy to clean.
Padded and adjustable shoulder straps.

Art.	cm	Pz./St.	€	EAN
431	60 x 30 x h 15	2	54,80-	8 016604 004315



stocker

www.stocker.com



TRONCARAMI

CORTARRAMAS
ASTSCHEREN
LOPPERS

Art. 7248

94



- Troncarami Profi Amboss
- Cortarramas Profi de yunque
- Astschere Profi Amboss
- Anvil lopper Profi

- Troncarami Profi Amboss
- Cortarramas Profi de yunque
- Astschere Profi Amboss
- Anvil lopper Profi



* fino ad esaurimento
* hasta agotamiento
* solange der Vorrat reicht
* While supplies last

Art.	cm	Gr.	Pz./St.	€	EAN
72080	80	1100	6	95,40-	8 016604 720802
72100	100	1200	6	97,80-	8 016604 721007

Art.	cm	Gr.	Pz./St.	€	EAN
7237	72	1300	6	70,80-	8 016604 072376
7238	93	1400	6	74,30-	8 016604 072383



- Troncarami Profi Amboss
- Cortarramas Profi de yunque
- Astschere Profi Amboss
- Anvil lopper Profi

Art.	cm	Gr.	Pz./St.	€	EAN
------	----	-----	---------	---	-----

72081	80	1100	6	95,40-	8 016604 720819
72101	100	1200	6	97,80-	8 016604 721014



- Troncarami Profi Bypass
- Cortarramas Profi Bypass
- Astschere Profi Bypass
- Bypass lopper Profi

- Troncarami Profi 80 Bypass
- Cortarramas Profi 80 Bypass
- Astschere Profi 80 Bypass
- Bypass lopper Profi 80



Art.	cm	Gr.	Pz./St.	€	EAN
7248	45	790	6	58,20-	8 016604 072482
7250	60	870	6	61,60-	8 016604 072505
7252	72	940	6	62,10-	8 016604 072529

Art.	cm	Gr.	Pz./St.	€	EAN
7236	80	1400	6	64,70-	8 016604 072369



- Troncarami telescopico Amboss 75 - 100 cm
- Cortarramas telescopico de yunque 75 - 100 cm
- Teleskop-Astschere Amboss 75 - 100 cm
- Telescopic Anvil lopper 75 - 100 cm



Art.	cm	Gr.	Pz./St.	€	EAN
2092	75 - 100	1500	6	74,10-	8 016604 020926



- Troncarami Hobby 66 Amboss con lama dritta
- Cortarramas Hobby 66 de yunque con hoja recta
- Astschere Hobby 66 Amboss mit gerader Klinge

- Anvil lopper Hobby 66 with straight blade

Art.	cm	Gr.	Pz./St.	€	EAN
7230	66	840	6	37,80-	8 016604 200854

Art.	cm	Gr.	Pz./St.	€	EAN
7232	65	760	6	37,10-	8 016604 072321



- Troncarami telescopico Bypass 75 - 100 cm
- Cortarramas telescopico Bypass 75 - 100 cm
- Teleskop-Astschere Bypass 75 - 100 cm

- Telescopic Bypass lopper 75 - 100 cm

Art.	cm	Gr.	Pz./St.	€	EAN
2094	75 - 100	1500	6	74,10-	8 016604 020940

Art.	cm	Gr.	Pz./St.	€	EAN
7242	75-100	1600	6	67,10-	8 016604 072420

stocker

www.stockergarden.com



TAGLIASIEPI

RECORTASETOS
HECKENSCHEREN
HEDGE SHEARS

Art. 20025

98



- Tagliasiepi Profi 65
- Recortasetos Profi 65
- Heckenschere Profi 65
- Hedge shears Profi 65

- Tagliasiepi Profi
- Recortasetos Profi
- Heckenschere Profi
- Hedge shears Profi



Art.	cm	Gr.	Pz./St.	€	EAN
2091	65	1.000	6	61,50-	8 016604 020919



Art.	cm	Gr.	Pz./St.	€	EAN
2023	63	1.000	6	60,40-	8 016604 020230
2025*	87	1.200	6	63,60-	8 016604 020254

* fino ad esaurimento
* hasta agotamiento
* solange der Vorrat reicht
* While supplies last



- Tagliasiepi telescopico
- Recortasetos telescópico
- Teleskop-Heckenschere
- Telescopic hedge shears



Art.	cm	Gr.	Pz./St.	€	EAN
2090	73 - 87	1.100	6	63,00-	8 016604 020902



- Tagliasiepi Hobby 55
- Recortasetos Hobby 55
- Heckenschere Hobby 55
- Hedge shears Hobby 55

- Tagliasiepi Hobby 55
- Recortasetos Hobby 55
- Heckenschere Hobby 55
- Hedge shears Hobby 55



Art.	cm	Gr.	Pz./St.	€	EAN
20025	55	872	6	38,00-	8 016604 0200250



Art.	cm	Gr.	Pz./St.	€	EAN
2039	55	898	6	39,40-	8 016604 020391



- Forbice tagliaerba 34
- Tijera cortacésped 34
- Grasschere 34
- Lawn shears 34



Art.	cm	Gr.	Pz./St.	€	EAN
2028	34	310	12	25,80-	8 016604 020285



- Forbice tagliaerba girevole 360°
- Tijera cortacésped giratoria 360°
- Grasschere drehbar 360°
- Lawn shears 360° revolving



Art.	cm	Gr.	Pz./St.	€	EAN
2032	34	310	12	28,50-	8 016604 020322



- Tagliasiepi Profi 56
- Recortasetos Profi 56
- Heckenschere Profi 56
- Hedge shears Profi 56

- Tagliasiepi Hobby 50
- Recortasetos Hobby 50
- Heckenschere Hobby 50
- Hedge shears Hobby 50



Art.	cm	Gr.	Pz./St.	€	EAN
2022	56	1.000	6	62,50-	8 016604 020223



Art.	cm	Gr.	Pz./St.	€	EAN
20015	50	760	6	22,70-	8 016604 0200151

Tosaerba
Cinque lame con affilatura di precisione, costruite in acciaio speciale temprato, per un perfetto prato all'inglese. Larghezza 30 cm.

Cortacésped
5 hojas con afilado de precisión, construido de acero especial templado, para un perfecto césped inglés. Ancho 30 cm.

Spindelmäher
Leises und umweltfreundliches Mähen. Die fünf präzisions-geschliffenen Messer aus superharten Spezialstahl, sorgen für den perfekten Rasen. Breite 30 cm.

Reel lawn mower
The mower is quiet and environmentally friendly. The blade is made from a super-hard special steel, to ensure a perfect cut. Width 30 cm.



* fino ad esaurimento
* hasta agotamiento
* solange der Vorrat reicht
* While supplies last

Art.	cm	Gr.	Pz./St.	€	EAN
3909	30 cm		2	106,50-	8 016604 039096



- Forbice tagliaerba girevole 360°
- Tijera cortacésped giratoria 360°
- Grasschere drehbar 360°
- Lawn shears 360° revolving



Art.	cm	Gr.	Pz./St.	€	EAN
2041	130	887	2	49,90-	8 016604 020414

stocker

www.stockergarden.com



FORBICI AD ASTA LUNGA

TIJERAS DE MANGO LARGO
LANGARMSCHEREN
LONG HANDLED PRUNING SHEARS

Art. 608

103



CHIAMATA DI SERVIZIO

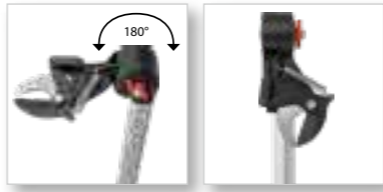

Forbice ad asta lunga telescopica

Dotata di chiusura di sicurezza e testa ruotabile di 180°.

Tijera de mango largo telescópica

Equipada con cierre de seguridad y cabeza giratoria de 180°.

Teleskop-Langarmschere

Mit Sicherheitsverschluss und 180° rotierbarem Kopf.

Telescopic long handled pruning shears

Equipped with safety closure and 180° adjustable cutting-head.



Art.	cm	Gr.	Pz./St.	€	EAN
606	170-280	1.350	2	128,00-	8 016604 906060



vedi pag. 327
ver página 327
siehe Seite 327
see on page 327



CHIAMATA DI SERVIZIO



Forbice ad asta lunga telescopica

Dotata di chiusura di sicurezza e testa ruotabile di 180°.

Tijera de mango largo telescópica

Equipada con cierre de seguridad y cabeza giratoria de 180°.

Teleskop-Langarmschere

Mit Sicherheitsverschluss und 180° rotierbarem Kopf.

Telescopic long handled pruning shears

Equipped with safety closure and 180° adjustable cutting-head.



Art.	cm	Gr.	Pz./St.	€	EAN
607	230-400	1.650	2	135,00-	8 016604 906077



vedi pag. 327
ver página 327
siehe Seite 327
see on page 327

PAOLO ZANI

ESPERTO DI OLIVICOLTURA PROFESSIONELLER OLIVENBAUER
EXPERTO EN OLIVICULTURA OLIVE GROWING EXPERT

“Grazie a questo attrezzo si evita l’uso della scala, consentendo di operare in tutta sicurezza da terra e riducendo così i tempi di potatura.”

“Gracias a esta herramienta se evita el uso de la escalera, permitiéndote trabajar con seguridad desde el suelo y reduciendo así los tiempos de poda.”

„Dieses Gerät schafft Abhilfe bei allen Schneidarbeiten vom Boden, sicheres Entasten und reduzierte Arbeitszeit durch mehr Effizienz sind garantiert.“

“Thanks to this tool, the use of the ladder is avoided, allowing you to work safely from the ground and thus reducing pruning times.”

Art. 607



CHIAMATA DI SERVIZIO

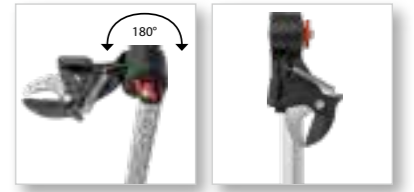

Forbice ad asta lunga fissa

Dotata di chiusura di sicurezza e testa ruotabile di 180°.

Tijera de mango largo fija

Equipada con cierre de seguridad y cabeza giratoria de 180°.

Langarmschere fixiert

Mit Sicherheitsverschluss und 180° rotierbarem Kopf.

Long handled pruning shears fixed

Equipped with safety closure and 180° adjustable cutting-head.

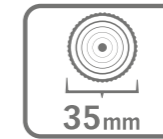

Art.	cm	Gr.	Pz./St.	€	EAN
608	170	930	2	99,40-	8 016604 906084



vedi pag. 328
ver página 328
siehe Seite 328
see on page 328

Tirare il manico (1) oppure la sfera all'estremità (2) per tagliare.
Tirar el mango (1) o la esfera en el extremo (2) para cortar.
Zum Schneiden den Griff (1) oder die Kugel am Verschluss (2) ziehen.
Pull the handle (1) or the sphere at the bottom (2) to cut.



CHIAMATA DI SERVIZIO

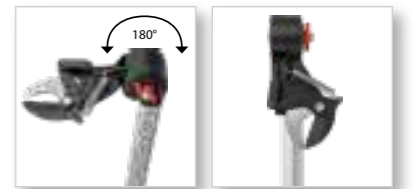

Forbice ad asta lunga fissa

Dotata di chiusura di sicurezza e testa ruotabile di 180°.

Tijera de mango largo fija

Equipada con cierre de seguridad y cabeza giratoria de 180°.

Langarmschere fixiert

Mit Sicherheitsverschluss und 180° rotierbarem Kopf.

Long handled pruning shears fixed

Equipped with safety closure and 180° adjustable cutting-head.

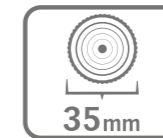

Art.	cm	Gr.	Pz./St.	€	EAN
609	220	1.050	2	103,00-	8 016604 906091



vedi pag. 328
ver página 328
siehe Seite 328
see on page 328

Tirare il manico (1) oppure la sfera all'estremità (2) per tagliare.
Tirar el mango (1) o la esfera en el extremo (2) para cortar.
Zum Schneiden den Griff (1) oder die Kugel am Verschluss (2) ziehen.
Pull the handle (1) or the sphere at the bottom (2) to cut.





Art.	cm	Gr.	Pz./St.	€	EAN
502	120	620	6	47,50-	8 016604 005022
503	150	660	6	54,70-	8 016604 005039
504	180	760	6	57,10-	8 016604 005046
505	200	790	6	61,60-	8 016604 005053

- Forbice ad asta lunga Bypass
- Tijera de mango largo Bypass
- Bypass-Langarmschere
- Long handled pruning shears Bypass



Art.	cm	Gr.	Pz./St.	€	EAN
508	130-200	880	6	88,50-	4 964590 040029

- Forbice telescopica Bypass
- Tijera telescópica Bypass
- Bypass-Teleskopschere
- Telescopic Bypass shears



Art.	cm	Gr.	Pz./St.	€	EAN
509	180-300	1.180	6	101,50-	8 016604 005091

- Forbice telescopica Bypass
- Tijera telescópica Bypass
- Bypass-Teleskopschere
- Telescopic Bypass shears



Art.	cm	Gr.	Pz./St.	€	EAN
510	180-300	1.200	6	89,30-	8 016604 005114

- Forbice telescopica Amboss
- Tijera telescópica de yunque
- Amboss-Teleskopschere
- Telescopic Anvil shears



* fino ad esaurimento
* hasta agotamiento
* solange der Vorrat reicht
* While supplies last



Art.	cm	Gr.	Pz./St.	€	EAN
604	180-300	1.300	6	100,50-	8 016604 006043

- Forbice telescopica orientabile
- Tijera telescópica orientable
- Teleskop-Schere mit beweglichem Kopf
- Adjustable telescopic shears



Art.	cm	Gr.	Pz./St.	€	EAN
603	130-200	1.042	6	93,40-	8 016604 006036

- Forbice telescopica orientabile
- Tijera telescópica orientable
- Teleskop-Schere mit beweglichem Kopf
- Adjustable telescopic shears



Art.	cm	Gr.	Pz./St.	€	EAN
600	60	450	6	50,20-	8 016604 006005

- Forbice taglia-tieni 60
- Tijera corta-sostiene 60
- Greifschere 60
- Cut and hold shears 60



Art.	cm	Gr.	Pz./St.	€	EAN
605	100	290	12	40,00-	8 016604 906053

- Raccogli-rifiuti
- Recoge desperdicios
- Unrat-Greifer
- Trash grabber



stocker

www.stocker.com



COMBISYSTEM

COMBISYSTEM
KOMBISYSTEM
COMBISYSTEM

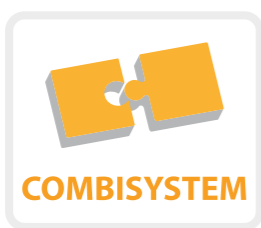
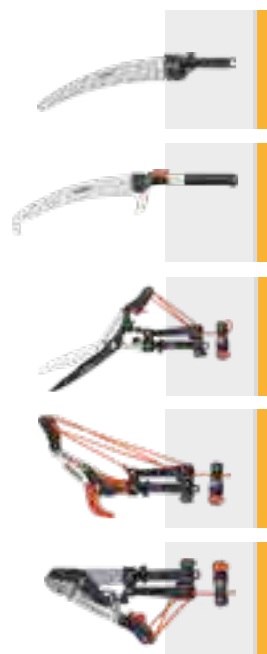

COMBISYSTEM

140 - 400 cm

per articolo / para artículo
für Artikel / for item

Art. 530 Art. 535
Art. 534 Art. 536
Art. 533

☑ Combisystem
Combisystem è la soluzione ideale per i lavori di taglio soprattutto per siepi e alberi. Utilizzato in combinazione con il manico telescopico in alluminio, è un attrezzo adatto e non pericoloso per la cura dell'arbusto. **Gli attrezzi compatibili con il manico sono:** gli sveltatoi, il taglia siepe e i seghetti. Il comando a cavo flessibile degli sveltatoi e dei taglia siepi rende meno faticoso il lavoro di taglio e con meno dispendio di energie.

☑ Combisystem
Combisystem es la solución ideal para el trabajo de corte, sobre todo para setos y árboles. Utilizado en combinación con el mango telescópico de aluminio, hace de él un utensilio apropiado para el cuidado del arbusto. **Los utensilios compatibles con el mango son:** las sierras de pértiga, el recortasetos y los serruchos. La forma de trabajo mediante cuerdas flexibles del desmochador y del cortasetos, hace menos pesado el trabajo del corte y con menos gasto de energía.

☑ Combisystem
Kombisystem ist die ideale Lösung bei Schneidearbeiten hoher Hecken und Bäume. Kombiniert mit dem Alu-Teleskopstiel ist eine fachgerechte und gefahrlose Baum- und Strauchpflege gewährleistet. **Die Geräteköpfe:** Raupenscheren, Heckenscheren und Sägen. Die Seilzugtechnik der Raupen- und Heckenschere ermöglicht ermüdungsfreies Schneiden in schwindelnder Höhe ohne jeden Kraftaufwand.

☑ Combisystem
Combisystem is the ideal solution for cutting high trees and hedges. With the telescopic aluminum handles, it is possible to practice a safe tree and hedge care. **Tools that are compatible with the handles are:** the loppers, the hedge trimmer and the pruning saws. The bypass lopper's cable-pull technique makes cutting less strenuous.



- ☑ Manico telescopico Profi Combisystem**
- ☑ Mango telescópico Profi Combisystem**
- ☑ Teleskopstiel Profi Kombisystem**
- ☑ Telescopic handle Profi Combisystem**

Art.	cm		Gr.	Pz./St.	€	EAN
565	140-250	2	798	6	42,90-	8 016604 005657
566	175-325	2	981	6	49,80-	8 016604 005664
567	210-400	2	1.169	6	56,60-	8 016604 005671

vedi pag. 329
ver página 329
siehe Seite 329
see on page 329



- Attacco Combisystem per sveltatoi, taglia siepi e seghetti.
- Conexión Combisystem para sierras de pértiga, recortasetos y serruchos.
- Kombisystem-Aufsatz für Raupenscheren, Heckenscheren und Sägen.
- Combisystem connection for loppers, hedge trimmer and pruning saws.
- Sistema di bloccaggio con leva PROFÍ per una perfetta stabilità.
- Sistema de bloqueo con palanca PROFÍ para una perfecta estabilidad.
- PROFÍ Blockierhebel für perfekte Stabilität.
- Locking system with PROFÍ clip for a perfect stability.



- ☑ Sveltatoio Amboss Combisystem**
Applicabile sui manici telescopici 565, 566, 567.
- ☑ Desmochador de yunque Combisystem**
Aplicable a los mangos telescópicos 565, 566, 567.
- ☑ Amboss-Raupenschere Kombisystem**
Kombinierbar mit Teleskopstielen 565, 566, 567.
- ☑ Combisystem Anvil lopper**
Compatible with telescopic handles 565, 566, 567.



Art.	cm	Gr.	Pz./St.	€	EAN
530	36,5	1.030	6	54,70-	8 016604 005305

- ☑ Sveltatoio Bypass Combisystem**
Applicabile sui manici telescopici 565, 566, 567.
- ☑ Desmochador Bypass Combisystem**
Aplicable a los mangos telescópicos 565, 566, 567.
- ☑ Bypass-Raupenschere Kombisystem**
Kombinierbar mit Teleskopstielen 565, 566, 567.
- ☑ Combisystem Bypass lopper**
Compatible with telescopic handles 565, 566, 567.



Art.	cm	Gr.	Pz./St.	€	EAN
534	43,5	760	6	43,60-	8 016604 005343

- ☑ Tagliasiepi Combisystem**
Applicabile sui manici telescopici 565, 566, 567.
- ☑ Recortasetos Combisystem**
Aplicable a los mangos telescópicos 565, 566, 567.
- ☑ Heckenschere Kombisystem**
Kombinierbar mit Teleskopstielen 565, 566, 567.
- ☑ Combisystem hedge trimmer**
Compatible with telescopic handles 565, 566, 567.



Art.	cm	Gr.	Pz./St.	€	EAN
533	46	815	6	47,00-	8 016604 005336

* fino ad esaurimento
* hasta agotamiento
* solange der Vorrat reicht
* While supplies last

- ☑ Seghetto 34 Combisystem**
Applicabile sui manici telescopici 565, 566, 567.
- ☑ Serrucho 34 Combisystem**
Aplicable a los mangos telescópicos 565, 566, 567.
- ☑ Säge 34 Kombisystem**
Kombinierbar mit Teleskopstielen 565, 566, 567.
- ☑ Saw 34 Combisystem**
Compatible with telescopic handles 565, 566, 567.

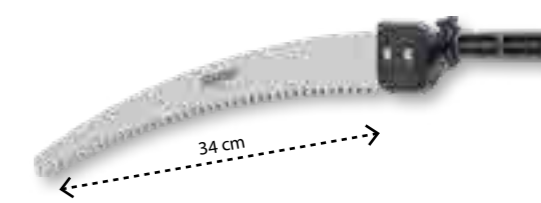

Art.	cm	Gr.	Pz./St.	€	EAN
535	34	220	6	37,00-	8 016604 005350

- ☑ Seghetto Falco 43 Combisystem**
Applicabile sui manici telescopici 565, 566, 567.
- ☑ Serrucho Falco 43 Combisystem**
Aplicable a los mangos telescópicos 565, 566, 567.
- ☑ Säge Falco 43 Kombisystem**
Kombinierbar mit Teleskopstielen 565, 566, 567.
- ☑ Falco saw 43 Combisystem**
Compatible with telescopic handles 565, 566, 567.

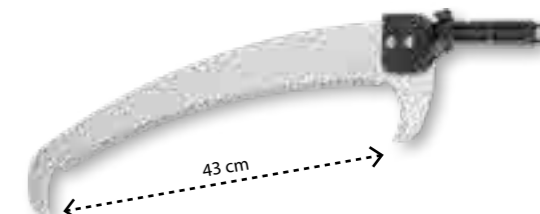

Art.	cm	Gr.	Pz./St.	€	EAN
536	43	290	6	44,90-	8 016604 005367



- ☑ **Manico telescopico Profi**
- ☑ **Mango telescópico Profi**
- ☑ **Teleskopstiel Profi**
- ☑ **Telescopic handle Profi**

UNIVERSAL ALU vedi pag. 329
ver página 329
siehe Seite 329
see on page 329

Art.	cm		Gr.	Pz./St.	€	EAN
568	145-260	2	819	6	47,60-	8 016604 005688
569	180-335	2	1.001	6	55,10-	8 016604 005695
570	220-410	2	1.184	6	62,10-	8 016604 005701

- Attacco universale con diametro di 2,5 cm per tutti i tipi di attrezzi per giardinaggio o casalinghi.
 - Conexión universal con diámetro de 2,5 cm para todos los tipos de herramientas para jardinería o enseres domésticos.
 - Universeller Aufsatz mit einem Durchmesser von 2,5 cm für alle Arten von Garten- und Haushaltsgeräten.
 - Universal connection with 2,5 cm diameter for all tools for gardening and household works.

- Sistema di bloccaggio con leva PROFÍ per una perfetta stabilità.
 - Sistema de bloqueo con palanca PROFÍ para una perfecta estabilidad.
 - PROFÍ Blockierhebel für perfekte Stabilität.
 - Locking system with PROFÍ locking clip for a perfect stability.



- ☑ **Manico telescopico**
- ☑ **Mango telescópico**
- ☑ **Teleskopstiel**
- ☑ **Telescopic handle**

UNIVERSAL ALU vedi pag. 329
ver página 329
siehe Seite 329
see on page 329

Art.	cm		Gr.	Pz./St.	€	EAN
559	145-260	2	818	6	38,00-	8 016604 005596
560	180-335	2	994	6	43,80-	8 016604 005602
561	220-410	2	1.188	6	52,70-	8 016604 005619

- Attacco universale con diametro di 2,5 cm per tutti i tipi di attrezzi per giardinaggio o casalinghi.
 - Conexión universal con diámetro de 2,5 cm para todos los tipos de herramientas para jardinería o enseres domésticos.
 - Universeller Aufsatz mit einem Durchmesser von 2,5 cm für alle Arten von Garten- und Haushaltsgeräten.
 - Universal connection with 2,5 cm diameter for all tools for gardening and household works.

- Sistema di bloccaggio compatto e ancora meno ingombrante.
 - Sistema de bloqueo compacto y aún menos engoroso.
 - Kompaktes und platzsparendes Schließsystem.
 - The locking system is even smaller and not cumbersome at all.

☑ **Seghetto Corvo 430 TC**
L'intercapedine ogni 10 cm tra i denti della lama favorisce lo scarico della segatura. Lunga durata della lama grazie al trattamento dei denti ad impulsi termici. Applicabile sui manici telescopici art. 559, 560, 561, 568, 569, 570. Con custodia.

☑ **Serrucho Corvo 430 TC**
El espacio cada 10 cm entre los dientes de la hoja favorece la descarga del serrín. Larga duración de la hoja gracias al tratamiento de impulso térmico de los dientes. Aplicable en los mangos telescópicos art. 559, 560, 561, 568, 569, 570. Con funda.

☑ **Säge Corvo 430 TC**
Die Aussparungen alle 10 cm ermöglichen das Auswerfen der Holzspäne. Lange Lebensdauer der Klinge dank thermischer Impulsbehandlung. Kombinierbar mit den Teleskopstielen Art. 559, 560, 561, 568, 569, 570. Mit Hülle.

☑ **Saw Corvo 430 TC**
The gaps every 10 cm between the teeth of the blade facilitate the discharge of sawdust. Long lasting blade thanks to the impulse-hardened teeth. Compatible with telescopic handles art. 559, 560, 561, 568, 569, 570. With sheath.

UNIVERSAL vedi pag. 330
ver página 330
siehe Seite 330
see on page 330



Art.	cm	Gr.	Pz./St.	€	EAN
523	43	425	6	43,50-	8 016604 005237



- ☑ **Seghetto Corvo 430 TC con manico telescopico**
- ☑ **Serrucho Corvo 430 TC con mango telescópico**
- ☑ **Säge Corvo 430 TC mit Teleskopstiel**
- ☑ **Saw Corvo 430 TC with telescopic handle**

ALU

Art.	cm		Gr.	Pz./St.	€	EAN
577*	195-310	2	1245	2	83,80-	8 016604 005770
578**	230-385	2	1425	2	90,10-	8 016604 005787
579***	270-460	2	1610	2	96,00-	8 016604 005794

* Art. 568 + 523
** Art. 569 + 523
*** Art. 570 + 523

NICOLA SAMORÌ

ESPERTO DI OLIVICOLTURA PROFESSIONELLER OLIVENBAUER
EXPERTO EN OLIVICULTURA OLIVE GROWING EXPERT

“RECIDI I RAMI CON SEMPLICITÀ
Agganciare e recidere i rami più sottili senza sforzo e in totale sicurezza:
certo, con il becco del seghetto puoi farlo!”

“CORTA LAS RAMAS CON FACILIDAD
Enganchar y cortar las ramas más finas sin esfuerzo y con total seguridad:
¡seguro, con el pico del serrucho puedes hacerlo!”

„ZWEIGE MIT LEICHTIGKEIT SCHNEIDEN
Dünnere Äste schneiden und kürzen mühelos und sicher:
Mit dem Schnabel der Bügelsäge ist das kein Problem!”

“CUT BRANCHES WITH EASE
Clip and cut thinner branches effortlessly and safely:
sure, with the hacksaw's beak you can do it”



Seghetto Sirkos 330 TC
Lunga durata della lama grazie al trattamento dei denti ad impulsi termici. Applicabile sui manici telescopici art. 559, 560, 561, 568, 569, 570. Con custodia.

Serrucho Sirkos 330 TC
Larga duración de la hoja gracias al tratamiento de impulso térmico de los dientes. Aplicable en los mangos telescópicos art. 559, 560, 561, 568, 569, 570. Con funda.

Säge Sirkos 330 TC
Lange Lebensdauer der Klinge dank thermischer Impulsbehandlung. Kombinierbar mit den Art. 559, 560, 561, 568, 569, 570. Mit Hülle.

Saw Sirkos 330 TC
Long lasting blade thanks to the impulse-hardened teeth. Compatible with telescopic handles art. 559, 560, 561, 568, 569, 570. With sheath.



vedi pag. 330
ver página 330
siehe Seite 330
see on page 330



Art.	cm	Gr.	Pz./St.	€	EAN
511	33	350	6	38,95-	8 016604 005121

Seghetto Falco 430 TC
Lunga durata della lama grazie al trattamento dei denti ad impulsi termici. Applicabile sui manici telescopici art. 559, 560, 561, 568, 569, 570. Con custodia.

Serrucho Falco 430 TC
Larga duración de la hoja gracias al tratamiento de impulso térmico de los dientes. Aplicable en los mangos telescópicos art. 559, 560, 561, 568, 569, 570. Con funda.

Säge Falco 430 TC
Lange Lebensdauer der Klinge dank thermischer Impulsbehandlung. Kombinierbar mit den Art. 559, 560, 561, 568, 569, 570. Mit Hülle.

Saw Falco 430 TC
Long lasting blade thanks to the impulse-hardened teeth. Compatible with telescopic handles art. 559, 560, 561, 568, 569, 570. With sheath.



vedi pag. 330
ver página 330
siehe Seite 330
see on page 330



Art.	cm	Gr.	Pz./St.	€	EAN
518	43	450	6	44,20-	8 016604 005183



* Art. 568 + 511
** Art. 569 + 511
*** Art. 570 + 511

Seghetto Sirkos 330 TC con manico telescopico
Serrucho Sirkos 330 TC con mango telescópico
Säge Sirkos 330 TC mit Teleskopstiel
Saw Sirkos 330 TC with telescopic handle



Art.	cm	□□□□	Gr.	Pz./St.	€	EAN
571*	190-305	2	1170	2	79,40-	8 016604 005718
572**	225-380	2	1350	2	85,60-	8 016604 005725
573***	265-455	2	1535	2	91,50-	8 016604 005732



* Art. 568 + 518
** Art. 569 + 518
*** Art. 570 + 518

Seghetto Falco 430 TC con manico telescopico
Serrucho Falco 430 TC con mango telescópico
Säge Falco 430 TC mit Teleskopstiel
Saw Falco 430 TC with telescopic handle



Art.	cm	□□□□	Gr.	Pz./St.	€	EAN
574*	195-310	2	1270	2	84,70-	8 016604 005749
575**	230-385	2	1450	2	90,80-	8 016604 005756
576***	270-460	2	1635	2	96,80-	8 016604 005763

Art. 523/511/518
SEGHETTI
SERRUCHOS
SÄGEN
SAWS



Art. 523
La lama a gancio frontale permette di rimuovere agevolmente i rami tagliati.
La hoja de gancho frontal permite quitar fácilmente las ramas cortadas.
Praktisches Entfernen des Schnittgutes aus der Baumkrone durch vorderen Schneidezahn.
The frontal hook-blade allows to easily remove the cut branches.



Art. 511
Leggero e snello, entra agevolmente tra le chiome più folte.
Ligero y delgado, entra fácilmente entre las copas más espesas.
Leichter und schlanker Sägekopf für besseres Schneiden in dichten Verästelungen.
Lightweight and lean, effective even among tangled branches.



Art. 518
Il gancio posteriore taglia i rami sottili per un rapido accesso alla chioma.
El gancho trasero corta ramas finas para un rápido acceso a las ramas más gruesas.
Die Klängen erlauben ein einfaches Entfernen dünner Äste und führen zu einen schnelleren Zugang.
The rear hook cuts thin branches for a quicker access to thicker ones.



PRESA STABILE

AGARRE STABILE
STABILER ZWEIHANDGRIFF
SAFE GRIP

Preso stabile e sicura a due mani grazie all'impugnatura ergonomica e antiscivolo. Ottimale bilanciamento tra seghetto e manico e facile manovrabilità.

Agarre estable y seguro a dos manos gracias a la empuñadura ergonómica y antideslizante. Equilibrio óptimo entre serrucho y mango y fácil maniobrabilidad.

Stabiler und sicherer Zweihandgriff dank ergonomischer und rutschfester Verkleidung. Hervorragende Balance zwischen Sägekopf und -Griff für eine einfachere Handhabung.

Safe and stable grip with two hands thanks to the ergonomic, non-slip handle. Perfect balance between the saw and the handle and easy maneuverability.

Art. 559, 560, 561, 565, 566, 567, 568, 569,
570, 571, 572, 573, 574, 575, 576, 577, 578,
579, 580, 581, 584, 585



Espositore per manici e forbici ad asta lunga
In legno. Per 14 pezzi.

Expositor para mangos y tijeras de mango largo
De madera. Para 14 piezas.

Verkaufsständer für Teleskopstiele und Langarmscheren
Hergestellt aus Holz. Für 14 Stück.

Display for telescopic handles
Made from wood. For 14 pieces.

Per/para/für/for Art. 559, 560, 561, 565, 566, 567, 568, 569, 570, 571, 572, 573, 574, 575, 576, 577, 578, 579, 580, 581, 582, 583, 606, 607, 608, 609.



Art.	cm	Pz./St.	€	EAN
44	87 x 40 x h 98			8 016604 000447

Seghetto 34
Lunga durata della lama grazie al trattamento dei denti ad impulsi termici.
Applicabile sui manici telescopici Art. 559, 560, 561, 568, 569, 570.

Serrucho 34
Larga duración de la hoja gracias al tratamiento de impulso térmico de los dientes.
Se puede utilizar con los mangos telescópicos 559, 560, 561, 568, 569, 570.

Säge 34
Lange Lebensdauer der Klinge dank thermischer Impulsbehandlung.
Kombinierbar mit den Art. 559, 560, 561, 568, 569, 570.

Saw 34
Long lasting blade thanks to the impulse-hardened teeth.
Can be combined with Art. 559, 560, 561, 568, 569, 570.

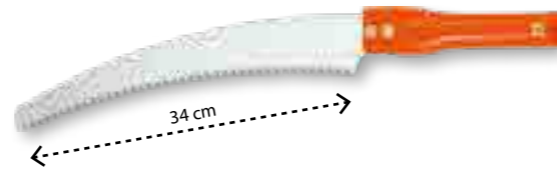

Art.	cm	Gr.	Pz./St.	€	EAN
514	34	312	6	30,20-	8 016604 005145



Seghetto Falco
Lunga durata della lama grazie al trattamento dei denti ad impulsi termici.
Applicabile sui manici telescopici Art. 559, 560, 561, 568, 569, 570.

Serrucho Falco
Larga duración de la hoja gracias al tratamiento de impulso térmico de los dientes.
Se puede utilizar con los mangos telescópicos 559, 560, 561, 568, 569, 570.

Säge Falco
Lange Lebensdauer der Klinge dank thermischer Impulsbehandlung.
Kombinierbar mit den Art. 559, 560, 561, 568, 569, 570.

Falco saw
Long lasting blade thanks to the impulse-hardened teeth.
Can be combined with Art. 559, 560, 561, 568, 569, 570.

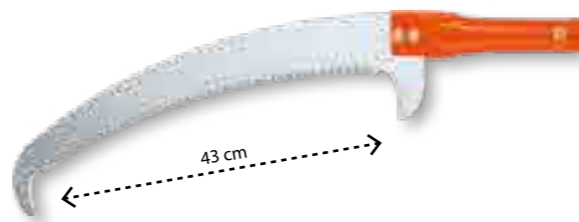

Art.	cm	Gr.	Pz./St.	€	EAN
515	43	390	6	37,30-	8 016604 005152



Svettatoio
Taglia rami con diametro fino a 40 mm.

Desmochador
Corta ramas con diámetro hasta 40 mm.

Raupenschere
Maximaler Schnittdurchmesser von 40 mm.

Lopper
Maximum cutting diameter: 40 mm.



Art.	cm	Gr.	Pz./St.	€	EAN
524	38	750	6	35,00-	8 016604 005244



Svettatoio
Taglia rami con diametro fino a 40 mm. Manico telescopico in fibra di vetro.

Desmochador
Corta ramas con diámetro hasta 40 mm. Mango telescópico de fibra de vidrio.

Raupenschere
Maximaler Schnittdurchmesser von 40 mm. Fiberglas-Teleskopstiel.

Lopper
Maximum cutting diameter: 40 mm. Fiberglass telescopic handle.



Art.	cm	Gr.	Pz./St.	€	EAN
527	144-255	2	1.490	67,30-	8 016604 005275

+ 2,7 MILIONI DI VISITE AL SITO

Appassionato, hobbista o professionista? Sul nostro sito i consumatori finali possono trovare descrizioni dei nostri innovativi prodotti, schede tecniche, consigli sui lavori nell'orto, frutteto e oliveto, ed anche news e approfondimenti su temi specifici.

www.stockergarden.com

+ 2.7 MILLION VISITS TO THE SITE

Enthusiast, hobbyist or professional? On our website end consumers can find descriptions of our innovative products, technical data sheets, tips on working in the garden, orchard and olive grove, as well as news and in-depth information on specific topics.



stocker

www.stockergarden.com



SEGHETTI PROFESSIONALI

SERRUCHOS PROFESIONALES
PROFI-SÄGEN
PROFESSIONAL SAWS

Art. 13527

120

Seghetto Suracon 210 LD

Leggero e robusto, in alluminio con manico ergonomico e rivestito in plastica antiscivolo. Lama dritta in acciaio speciale cromato. Punta dei denti trattate a impulsi termici, per una lunga durata della lama e un taglio preciso.

Serrucho Suracon 210 LD

Ligero y resistente, de aluminio con mango ergonómico y revestido de plástico antideslizante. Hoja recta en acero especial cromado. Puntas de los dientes tratadas con pulsos térmicos, para una larga duración de la hoja y un corte preciso.

Klappsäge Suracon 210 LD

Leicht und robust, aus Aluminium mit ergonomischem Griff und mit rutschfestem Kunststoff überzogen. Gerade Klinge aus verchromtem Spezialstahl. Impulsgehärtete Zahnspitzen für einen perfekten Schnitt und eine lange Lebensdauer.

Saw Suracon 210 LD

Light and sturdy, in aluminium with ergonomic handle covered with non-slip plastic. Straight chrome-plated blade. Impulse-hardened tooth tips for a long blade life and a perfect cut.



Art.	cm	Gr.	Pz./St.	€	EAN
12621	21	215	12	31,75-	8 016604 126215

Seghetto Suracon 210 LC

Leggero e robusto, in alluminio con manico ergonomico e rivestito in plastica antiscivolo. Lama curva in acciaio speciale cromato. Punta dei denti trattate a impulsi termici, per una lunga durata della lama e un taglio preciso.

Serrucho Suracon 210 LC

Ligero y resistente, de aluminio con mango ergonómico y revestido en plástico antideslizante. Hoja recta en acero especial cromado. Puntas de los dientes tratadas con pulsos térmicos, para una larga duración de la hoja y un corte preciso.

Klappsäge Suracon 210 LC

Leicht und robust, aus Aluminium mit ergonomischem Griff und mit rutschfestem Kunststoff überzogen. Gebogene Klinge aus verchromtem Spezialstahl. Impulsgehärtete Zahnspitzen für einen perfekten Schnitt und eine lange Lebensdauer.

Saw Suracon 210 LC

Light and sturdy, in aluminium with ergonomic handle covered with non-slip plastic. Curved chrome-plated blade. Impulse-hardened tooth tips for a long blade life and a perfect cut.



Art.	cm	Gr.	Pz./St.	€	EAN
12521	21	215	12	34,50-	8 016604 125218

Seghetto Sharki 180

Pieghevole, con lama curva in acciaio speciale cromato. Impugnatura ergonomica e antiscivolo. Punta dei denti trattate a impulsi termici, per una lunga durata della lama e un taglio preciso.

Serrucho Sharki 180

Plegable, con hoja curva de acero especial cromado. Empuñadura ergonómica y antideslizante. Puntas de los dientes tratadas con pulsos térmicos, para una larga duración de la hoja y un corte preciso.

Klappsäge Sharki 180

Zusammenklappbar, mit gebogener Klinge aus verchromtem Spezialstahl. Ergonomischer und rutschfester Griff. Impulsgehärtete Zahnspitzen für einen perfekten Schnitt und eine lange Lebensdauer.

Saw Sharki 180

Foldable, with curved chrome-plated blade. Ergonomic and non-slip handle. Impulse-hardened tooth tips for a long blade life and a perfect cut.



Art.	cm	Gr.	Pz./St.	€	EAN
12518	18	195	12	24,15-	8 016604 125188



Seghetto Tornado 180

Pieghevole, con lama dritta in acciaio speciale cromato. Impugnatura ergonomica e antiscivolo. Punta dei denti trattate a impulsi termici, per una lunga durata della lama e un taglio preciso.

Serrucho Tornado 180

Plegable, con hoja recta de acero especial cromado. Empuñadura ergonómica y antideslizante. Puntas de los dientes tratadas con pulsos térmicos, para una larga duración de la hoja y un corte preciso.

Klappsäge Tornado 180

Zusammenklappbar, mit gerader Klinge aus verchromtem Spezialstahl. Ergonomischer und rutschfester Griff. Impulsgehärtete Zahnspitzen für einen perfekten Schnitt und eine lange Lebensdauer.

Saw Tornado 180

Foldable, with straight chrome-plated blade. Ergonomic and non-slip handle. Impulse-hardened tooth tips for a long blade life and a perfect cut.



Art.	cm	Gr.	Pz./St.	€	EAN
11518	18	195	12	20,45-	8 016604 115189

Seghetto Zyklon 180

Pieghevole, con lama dritta in acciaio speciale cromato. Impugnatura ergonomica e antiscivolo. Punta dei denti trattate a impulsi termici, per una lunga durata della lama e un taglio preciso.

Serrucho Zyklon 180

Plegable, con hoja recta de acero especial cromado. Empuñadura ergonómica y antideslizante. Puntas de los dientes tratadas con pulsos térmicos, para una larga duración de la hoja y un corte preciso.

Klappsäge Zyklon 180

Zusammenklappbar, mit gerader Klinge aus verchromtem Spezialstahl. Ergonomischer und rutschfester Griff. Impulsgehärtete Zahnspitzen für einen perfekten Schnitt und eine lange Lebensdauer.

Saw Zyklon 180

Foldable, with straight chrome-plated blade. Ergonomic and non-slip handle. Impulse-hardened tooth tips for a long blade life and a perfect cut.



Art.	cm	Gr.	Pz./St.	€	EAN
1419	18	197	12	22,10-	8 016604 014192



Start Kit Potatura
Kit di base per la potatura formato da seghetto pieghevole con lama da 18 cm (Art. 1419) e forbici bypass super leggere (Art. 323).

Start Kit Poda
Kit base para la poda formado por un serrucho plegable con hoja de 18 cm (Art. 1419) y tijera bypass (Art. 323) super ligeras.

Start Kit Baumschnitt
Basis-Kit für den Baumschnitt. Mit Klappsäge 18 cm Klinge (Art. 1419) und superleichter Bypass-Gartenschere (Art. 323).

Pruning starter kit
Pruning starter kit with folding saw 18 cm blade (Art. 1419) and lightweight bypass pruning shears (Art. 323).

Art.	cm	Gr.	Pz./St.	€	EAN
1420	18/19,5	197/184	6	37,20-	8 016604 014208



Seghetto Sirkos con fodero
Massima robustezza grazie alla lama che continua nel manico. Impugnatura ergonomica e antiscivolo. Punta dei denti trattata a impulsi termici, per una lunga durata della lama e un taglio preciso.

Serrucho Sirkos con funda
Máxima resistencia gracias a la hoja que continúa en el mango. Empuñadura ergonómica y antideslizante. Puntas de los dientes tratadas con pulsos térmicos, para una larga duración de la hoja y un corte preciso.

Handsäge Sirkos mit Hülle
Fortsetzung des Stahls bis in den Griff für mehr Stabilität. Ergonomischer und rutschfester Griff. Impulsgehärtete Zahnschneiden für einen perfekten Schnitt und eine lange Lebensdauer.

Saw Sirkos with sheath
Extreme sturdiness as the blade continues into the handle. Ergonomic and non-slip handle. Impulse-hardened tooth tips for a long blade life and a perfect cut.

Art.	cm	Gr.	Pz./St.	€	EAN
14527	27	204	12	35,55-	8 016604 145278
14533	33	230	12	36,70-	8 016604 145339



Seghetto Sirkos senza fodero
Massima robustezza grazie alla lama che continua nel manico. Impugnatura ergonomica e antiscivolo. Punta dei denti trattata a impulsi termici, per una lunga durata della lama e un taglio preciso.

Serrucho Sirkos sin funda
Máxima resistencia gracias a la hoja que continúa en el mango. Empuñadura ergonómica y antideslizante. Puntas de los dientes tratadas con pulsos térmicos, para una larga duración de la hoja y un corte preciso.

Handsäge Sirkos ohne Hülle
Fortsetzung des Stahls bis in den Griff für mehr Stabilität. Ergonomischer und rutschfester Griff. Impulsgehärtete Zahnschneiden für einen perfekten Schnitt und eine lange Lebensdauer.

Saw Sirkos without sheath
Extreme sturdiness as the blade continues into the handle. Ergonomic and non-slip handle. Impulse-hardened tooth tips for a long blade life and a perfect cut.

Art.	cm	Gr.	Pz./St.	€	EAN
14627	27	204	12	20,90-	8 016604 146275



* fino ad esaurimento
* hasta agotamiento
* solange der Vorrat reicht
* While supplies last

Seghetto Sciocco
Massima robustezza grazie alla lama che continua nel manico. Impugnatura ergonomica e antiscivolo. Punta dei denti trattata a impulsi termici, per una lunga durata della lama e un taglio preciso.

Serrucho Sciocco
Máxima resistencia gracias a la hoja que continúa en el mango. Empuñadura ergonómica y antideslizante. Puntas de los dientes tratadas con pulsos térmicos, para una larga duración de la hoja y un corte preciso.

Handsäge Sciocco
Fortsetzung des Stahls bis in den Griff für mehr Stabilität. Ergonomischer und rutschfester Griff. Impulsgehärtete Zahnschneiden für einen perfekten Schnitt und eine lange Lebensdauer.

Saw Sciocco
Extreme sturdiness as the blade continues into the handle. Ergonomic and non-slip handle. Impulse-hardened tooth tips for a long blade life and a perfect cut.

Art.	cm	Gr.	Pz./St.	€	EAN
13521	21	165	12	30,50-	8 016604 135217
13524	24	175	12	32,10-	8 016604 135248
13527	27	190	12	33,85-	8 016604 135279
13530	30	190	12	35,45-	8 016604 135309



Seghetto Maestral
Fisso, con lama dritta in acciaio speciale cromato. Impugnatura ergonomica e antiscivolo. Punta dei denti trattata a impulsi termici, per una lunga durata della lama e un taglio preciso.

Serrucho Maestral
Fijo, con hoja recta de acero especial cromado. Empuñadura ergonómica y antideslizante. Puntas de los dientes tratadas con pulsos térmicos, para una larga duración de la hoja y un corte preciso.

Handsäge Maestral
Fixiert, mit gerader Klinge aus verchromtem Spezialstahl. Leichter und rutschfester Griff. Impulsgehärtete Zahnschneiden für einen perfekten Schnitt und eine lange Lebensdauer.

Saw Maestral
Handsaw with straight chrome-plated blade. Ergonomic and non-slip handle. Impulse-hardened tooth tips for a long blade life and a perfect cut.



Art.	cm	Gr.	Pz./St.	€	EAN
1512	21	148	12	24,80-	8 016604 015120
1514	25	156	12	26,40-	8 016604 015144
1515	30	170	12	29,00-	8 016604 015151

Seghetto con manico ad ombrello
Fisso, con lama dritta in acciaio speciale cromato. Manico leggero e antiscivolo. Punta dei denti trattata a impulsi termici, per una lunga durata della lama e un taglio preciso.

Serrucho con mango de paraguas
Fijo, con hoja recta de acero especial cromado. Mango ligero y antideslizante. Puntas de los dientes tratadas con pulsos térmicos, para una larga duración de la hoja y un corte preciso.

Säge mit Schirmgriff
Fixiert, mit gerader Klinge aus verchromtem Spezialstahl. Leichter und rutschfester Griff. Impulsgehärtete Zahnschneiden für einen perfekten Schnitt und eine lange Lebensdauer.

Saw with umbrella handle
Handsaw with straight chrome-plated blade. Lightweight and non-slip handle. Impulse-hardened tooth tips for a long blade life and a perfect cut.



* fino ad esaurimento
* hasta agotamiento
* solange der Vorrat reicht
* While supplies last

Art.	cm	Gr.	Pz./St.	€	EAN
1505*	25	204	12	23,10-	8 016604 015052
1507	30	218	12	24,80-	8 016604 015076
1506*	35	245	12	26,80-	8 016604 015069

Seghetto con manico ad ombrello 300
Fisso, con lama dritta in acciaio speciale cromato. Manico a ombrello in alluminio. Punta dei denti trattata a impulsi termici, per una lunga durata della lama e un taglio preciso.

Serrucho con mango de paraguas 300
Fijo, con hoja recta de acero especial cromado. Mango de paraguas de aluminio. Puntas de los dientes tratadas con pulsos térmicos, para una larga duración de la hoja y un corte preciso.

Handsäge mit Schirmgriff 300
Fixiert, mit gerader Klinge aus verchromtem Spezialstahl. Aluminium-Schirmgriff. Impulsgehärtete Zahnschneiden für einen perfekten Schnitt und eine lange Lebensdauer.

Saw with umbrella handle 300
Handsaw with straight chrome-plated blade. Umbrella-handle made from aluminium. Impulse-hardened tooth tips for a long blade life and a perfect cut.



Art.	cm	Gr.	Pz./St.	€	EAN
1513	30	254	12	25,70-	8 016604 015137



stocker

www.stockergarden.com



POMPE MANUALI

**BOMBAS MANUALES
MANUELLE DRUCKPUMPEN
MANUAL SPRAYERS**



2x FIBRE GLASS ALU

Set con lancia aggiuntiva (Art. 242/38).
Set con lanza adicional (Art. 242/38).
Set inklusive Zusatz-handbrause (Art. 242/38).
Set includes additional lance (Art. 242/38).

- ☑ **Pompa a zaino a pressione 12 L**
- ☑ **Bomba de mochila de presión 12 L**
- ☑ **Rückenspritze 12 L**
- ☑ **Pressure backpack sprayer 12 L**

12 LITER 91 cm LEFT & RIGHT

vedi pag. 331
ver página 331
siehe Seite 331
see on page 331

Art.	lt.	Gr.	Pz./St.	€	EAN
243	12	2.902	4	59,50-	8 016604 002434



- ☑ **Pompa a pressione 8 L**
- ☑ **Bomba de presión 8 L**
- ☑ **Druckpumpe 8 L**
- ☑ **Pressure sprayer 8 L**

8 LITER 50 cm

Art.	lt.	Gr.	Pz./St.	€	EAN
256	8	1.775	6	35,10-	8 016604 002564



2x FIBRE GLASS ALU

Set con lancia aggiuntiva (Art. 242/38).
Set con lanza adicional (Art. 242/38).
Set inklusive Zusatz-handbrause (Art. 242/38).
Set includes additional lance (Art. 242/38).

- ☑ **Pompa a zaino a pressione 16 L**
- ☑ **Bomba de mochila de presión 16 L**
- ☑ **Rückenspritze 16 L**
- ☑ **Pressure backpack sprayer 16 L**

16 LITER 91 cm LEFT & RIGHT

vedi pag. 332
ver página 332
siehe Seite 332
see on page 332

Art.	lt.	Gr.	Pz./St.	€	EAN
248	16	3.050	3	64,70-	8 016604 002489

- ☑ **Pompa a pressione 5 L**
- ☑ **Bomba de presión 5 L**
- ☑ **Druckpumpe 5 L**
- ☑ **Pressure sprayer 5 L**

5 LITER 50 cm

Art.	lt.	Gr.	Pz./St.	€	EAN
254	5	1.350	6	30,90-	8 016604 002540



☑ **Espositore per pompa a pressione 5 L**
Il display include 16 pompe a pressione, ns. Art. 254, e rende perfetta la presentazione del prodotto stesso.

☑ **Expositor para bomba de presión 5 L**
El display contiene 16 bombas de presión, nuestro artículo 254, y ofrece una presentación óptimal del producto.

☑ **Display Druckpumpe 5 L**
Das Display enthält 16 Kompressions-Pumpen des Art. 254 und bietet eine echte Verkaufshilfe zur optimalen Warenpräsentation.

☑ **Display for pressure sprayer 5 L**
The display box provides space for 16 five-liter compression pumps, Art. 254. Perfect for mass quantity sales.

Art.	lt.	Gr.	Pz./St.	€	EAN
1254	5	1.132	16	26,90-	8 016604 012549



2x FIBRE GLASS ALU

Set con lancia aggiuntiva (Art. 242/38).
Set con lanza adicional (Art. 242/38).
Set inklusive Zusatz-handbrause (Art. 242/38).
Set includes additional lance (Art. 242/38).

- ☑ **Pompa a zaino a pressione 20 L**
- ☑ **Bomba de mochila de presión 20 L**
- ☑ **Rückenspritze 20 L**
- ☑ **Pressure backpack sprayer 20 L**

20 LITER 91 cm LEFT & RIGHT

vedi pag. 333
ver página 333
siehe Seite 333
see on page 333

Art.	lt.	Gr.	Pz./St.	€	EAN
249	20	3.094	3	72,40-	8 016604 002496

- ☑ **Pompa a pressione 5 L FPM**
Adatta a spruzzare prodotti aggressivi.
- ☑ **Bomba de presión 5 L FPM**
Adecuada para pulverizar productos agresivos.
- ☑ **Druckpumpe 5 L FPM**
Geeignet zum Sprühen von aggressiven Mitteln.
- ☑ **Pressure sprayer 5 L FPM**
Ideal for spraying aggressive solutions.

FPM 5 LITER 50 cm

Art.	lt.	Gr.	Pz./St.	€	EAN
261	5	1.479	6	40,80-	8 016604 002618



- ☑ **Pompa a pressione 5 L e spruzzino 1 L**
- ☑ **Bomba de presión 5 L y nebulizador 1 L**
- ☑ **Druckpumpe 5 L und Sprüher 1 L**
- ☑ **Pressure sprayer 5 L and sprayer 1 L**

5 LITER 60-89 cm

Art.	lt.	Gr.	Pz./St.	€	EAN
255	5	1.479	6	37,20-	8 016604 002557

★ NEW

Pompa a pressione con ugello per schiuma 2 L FPM
Adatta per utilizzo con sapone per lavaggio.

Bomba de presión con boquilla de espuma 2 L FPM
Adecuado para su uso con jabón de lavar.

Druckpumpe mit Schaumdüse 2 L FPM
Für die Verwendung mit Waschseife.

Pressure sprayer with foam nozzle 2 L FPM
Suitable for use with washing soap.



Art.	lt.	Gr.	Pz./St.	€	EAN
307	2	500	12	14,00-	8 016604 003073

★ NEW

Pompa a pressione 360° 2 L FPM
Adatta a spruzzare prodotti aggressivi. Funziona in qualsiasi posizione, anche capovolta.

Bomba de presión 360° 2 L FPM
Adecuada para rociar productos agresivos. Funciona en cualquier posición, incluso boca invertida.

Drucksprüher 360° 2 L FPM
Geeignet zum Sprühen von aggressiven Mitteln. Funktioniert in jeder Lage, auch über Kopf.

Pressure sprayer 360° 2 L FPM
Ideal for spraying aggressive solutions. Works at any angle, even upside down.



Art.	lt.	Gr.	Pz./St.	€	EAN
306	2	530	12	18,90-	8 016604 003066

★ NEW

Pompa a pressione 360° 2 L
Funziona in qualsiasi posizione, anche capovolta.

Bomba de presión 360° 2 L
Funciona en cualquier posición, incluso boca invertida.

Drucksprüher 360° 2 L
Funktioniert in jeder Lage, auch über Kopf.

Pressure sprayer 360° 2 L
Works at any angle, even upside down.



Art.	lt.	Gr.	Pz./St.	€	EAN
300	2	530	12	14,70-	8 016604 0903007



Pompa a pressione ECON 1,5 L
Bomba de presión ECON 1,5 L
Drucksprüher ECON 1,5 L
Pressure sprayer ECON 1,5 L



Art.	lt.	Gr.	Pz./St.	€	EAN
2906	1,5	370	15	9,60-	8 016604 029066

Pompa a pressione ECON 2 L
Con valvola di sicurezza.

Bomba de presión ECON 2 L
Con válvula de seguridad.

Drucksprüher ECON 2 L
Mit Überdruckventil.

Pressure sprayer ECON 2 L
With safety valve.



Art.	lt.	Gr.	Pz./St.	€	EAN
2907	2	376	15	10,80-	8 016604 029073



Spruzzino ECON 1 L
Nebulizador ECON 1 L
Handsprüher ECON 1 L
Sprayer ECON 1 L



Art.	lt.	Gr.	Pz./St.	€	EAN
2900	1	126	48	3,10-	8 016604 029004



Pompa a pressione COLOR 1,5 L
Bomba de presión COLOR 1,5 L
Drucksprüher COLOR 1,5 L
Pressure sprayer COLOR 1,5 L



Art.	lt.	col./Farbe	Pz./St.	€	EAN
2905	1,5	■ ■ ■ ■ ■	18	8,30-	8 016604 029059



Spruzzino COLOR 550 ml
Nebulizador COLOR 550 ml
Handsprüher COLOR 550 ml
Sprayer COLOR 550 ml



Art.	lt.	col./Farbe	Pz./St.	€	EAN
2902	0,55	■ ■ ■ ■ ■	18	1,80-	8 016604 029028



Spruzzino COLOR 500 ml
Nebulizador COLOR 500 ml
Handsprüher COLOR 500 ml
Sprayer COLOR 500 ml



Art.	lt.	col./Farbe	Pz./St.	€	EAN
2901	0,5	■ ■ ■ ■ ■	18	2,10-	8 016604 029011



Display pompa a pressione COLOR 1,5 L
Expositor bomba de presión COLOR 1,5 L
Display Drucksprüher COLOR 1,5 L
Display pressure sprayer COLOR 1,5 L

Art.	cm	Gr.	Pz./St.	€	EAN
29051			36	8,20-	8 016604 290534



Spruzzino COLOR 300 ml
Nebulizador COLOR 300 ml
Handsprüher COLOR 300 ml
Sprayer COLOR 300 ml



Art.	lt.	col./Farbe	Pz./St.	€	EAN
2904	0,3	■ ■ ■ ■ ■	18	1,50-	8 016604 029042



Spruzzino 900 ml
Nebulizador 900 ml
Handsprüher 900 ml
Sprayer 900 ml



Art.	lt.	col./Farbe	Pz./St.	€	EAN
2899	0,9	■	12	5,20-	8 016604 028991
2903	0,9	■	12	5,20-	8 016604 029035

* fino ad esaurimento
* hasta agotamiento
* solange der Vorrat reicht
* While supplies last

- Innaffiatoio**
- Regadera**
- Gießkanne**
- Watering can**

* fino ad esaurimento
* hasta agotamiento
* solange der Vorrat reicht
* While supplies last

- 2,5 LITER
- 4,5 LITER
- 8 LITER
- 10,5 LITER
- 13,5 LITER
- X

Art.	lt.	col./Farbe	Pz./St.	€	EAN
263*	2,5	■	14	7,30-	8 016604 002632
270	2,5	■	14	7,40-	4 002538 640037
265*	4,5	■	10	7,70-	8 016604 002656
271	4,5	■	10	7,90-	4 002538 640051
275*	8	■	14	9,90-	8 016604 002755
272	8	■	14	10,10-	4 002538 640082
283*	10,5	■	12	11,30-	8 016604 002830
273	10,5	■	12	11,50-	4 002538 640105
285*	13,5	■	10	14,00-	8 016604 002854
274	13,5	■	10	14,30-	4 002538 640136



- Innaffiatoio verde**
Innaffiatoio classico in robusta plastica verde.
- Regadera verde**
Regadera clásica de resistente plástico verde.
- Gießkanne grün**
Klassische Gießkanne aus stabilem, grünem Kunststoff.
- Green watering can**
Classic watering can made from sturdy green plastic.

- 2 LITER
- 5 LITER
- 10 LITER
- X

Art.	lt.	col./Farbe	Pz./St.	€	EAN
278	2	■	12	6,20-	8 016604 002786
281	5	■	8	7,00-	8 016604 002816
288	10	■	8	9,50-	8 016604 002885



INSTAGRAM: OGNI SETTIMANA POST, REELS E STORIES

Uno spazio di condivisione di interessi per una giovane community formata da famiglie e giovani hobbisti appassionati di giardinaggio!

@stockergardenitalia



INSTAGRAM: WEEKLY POSTS, REELS AND STORIES

A space for sharing interests for a young community of families and young hobbyists with a passion for gardening!

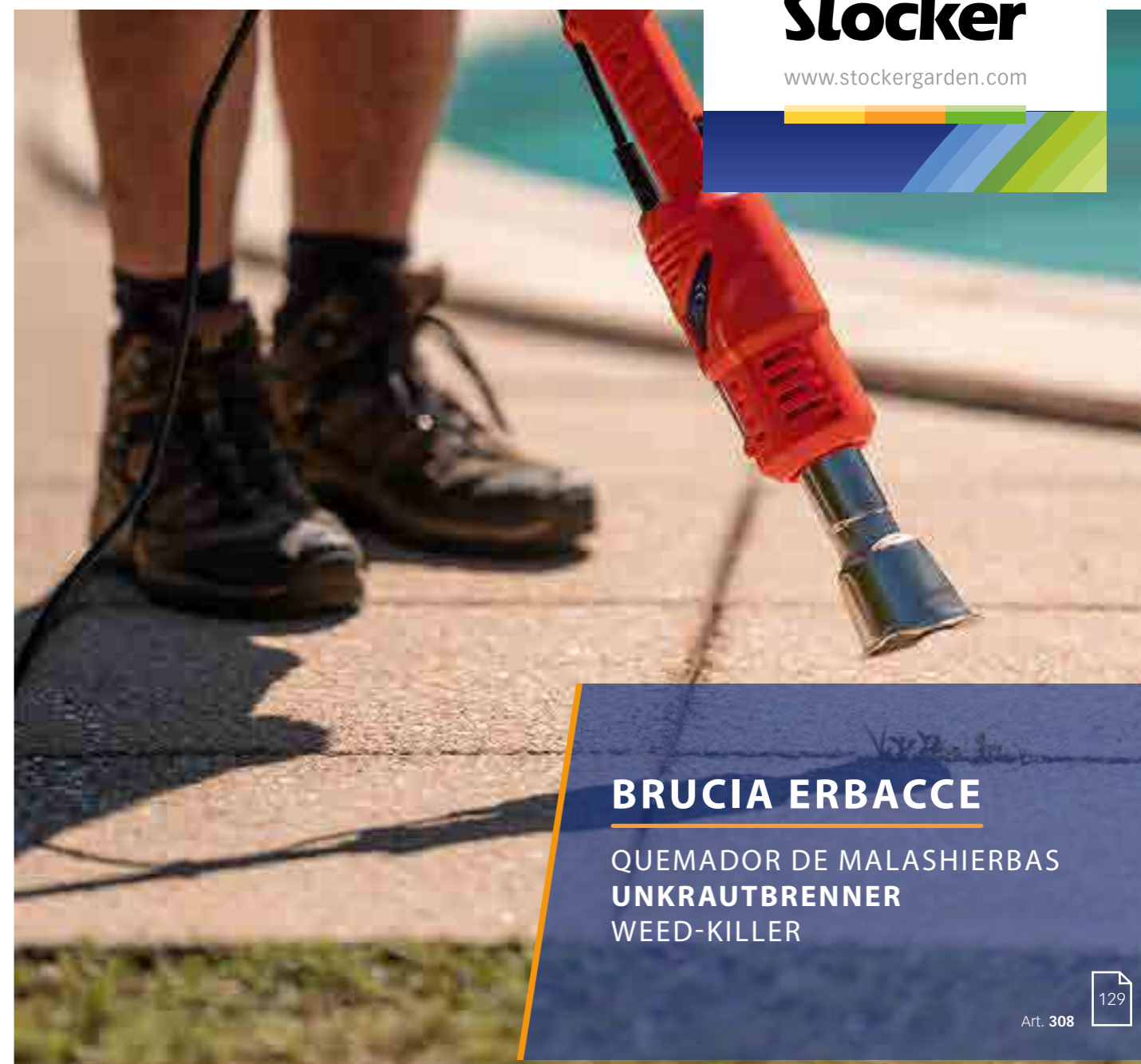

- Diserbante termico elettrico**
L'alternativa ecologica ai diserbanti chimici. Il calore emanato uccide le erbacce in pochi secondi. Lunghezza ideale per raggiungere il terreno senza piegare la schiena. Due livelli di temperatura selezionabili: 50 °C e 600 °C. Dotato di cavo da 180 cm.
- Herbicida térmico eléctrico**
La alternativa ecológica a los herbicidas químicos. El calor emanado mata las malezas en unos segundos. Longitud ideal para alcanzar el suelo sin doblar la espalda. Dos niveles de temperatura elegibles: 50 °C y 600 °C. Con cable de 180 cm.
- Elektrischer Unkrautbrenner**
Ökologische Alternative zu chemischen Herbiziden. Die abgegebene Hitze tötet das Unkraut in wenigen Sekunden. Ideale Länge, um den Boden zu erreichen, ohne sich zu bücken. Zwei einstellbare Temperaturstufen: 50 °C und 600 °C. Mit 180 cm langen Kabel.

- Electric thermal weed-killer**
The ecologic alternative to chemical weed-killers. The heat kills the weeds in few seconds. Ideal length to easily reach the ground without bending. Two heat-settings available: 50 °C and 600 °C. Equipped with a 180 cm cable.

- ELECTRO
- 600°C
- X
- vedi pag. 340 / ver página 340 / siehe Seite 340 / see on page 340

Art.	cm.	Gr.	Pz./St.	€	EAN
308	127	1.000	4	43,40-	8 016604 003080

* fino ad esaurimento
* hasta agotamiento
* solange der Vorrat reicht
* While supplies last



stocker

www.stockergarden.com



MICRO-IRRIGAZIONE

MICRORRIEGO
MICRO-BEWÄSSERUNG
MICRO IRRIGATION

Art. 28001

132

IT • Per l'irrigazione di orti fino a 60 m².
 • Compatible con altri sistemi con Ø 13-16 mm.
 • Personalizzabile e modulare, ottimizza il processo di irrigazione grazie ai diversi gocciolatori inclusi.

DE • Für die Bewässerung von Gemüsegärten bis zu 60 m².
 • Kompatibel mit anderen Systemen zu Ø 13-16 mm.
 • Personalisierbar und modular, optimiert den Bewässerungsprozess dank der verschiedenen Tropfköpfe.

ES • Para el riego de huertos hasta 60 m².
 • Compatible con otros sistemas con Ø 13-16 mm.
 • Personalizable y modular, optimiza el proceso de riego gracias a los diferentes goteiros incluidos.

EN • For the irrigation of vegetable gardens of up to 60 m².
 • Compatible with other Ø 13-16 mm micro-irrigation systems.
 • Customizable and scalable system, optimizes the irrigation process thanks to the different drippers included.

Art. 28001

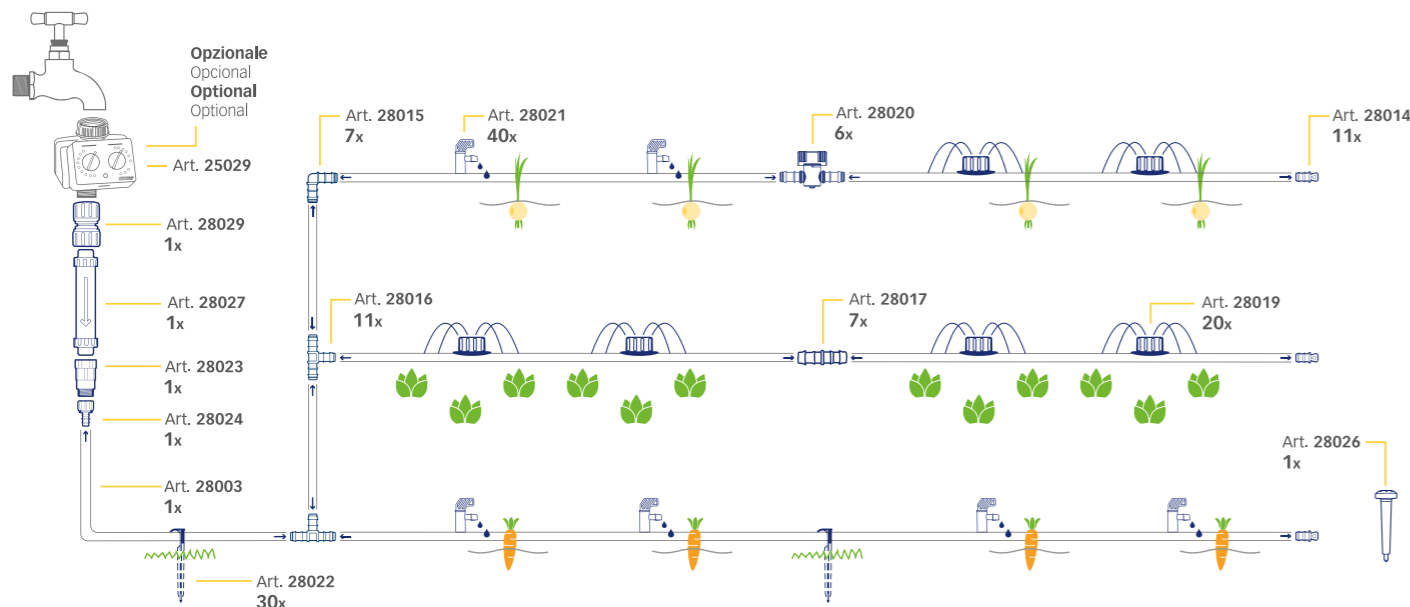

- Set micro irrigazione per orto**
Con tubo da 25 metri.
- Set microrriego para huerto**
Con tubo de 25 metros.
- Micro-Bewässerungsset für Gemüsegarten**
Mit Schlauch von 25 Meter.
- Micro irrigation set for vegetable garden**
With 25 meters tube.



Art.	Ø mm	Pz./St.	€	EAN
28001	13-16	4	70,60-	8 016604 280016

IT **Tappo terminale Ø 13-16 mm**
ES **Tapón terminal Ø 13-16 mm**
DE **Abschlusskappe Ø 13-16 mm**
EN **Terminal cap Ø 13-16 mm**

5 pz./blister
5 pcs/blister
5 St./Blister
5 pcs/blister pack

1/2", 5 x



Art.	Ø mm	Pz./St.	€	EAN
28014	13-16	12	2,10-	8 016604 280146

IT **Raccordo a 90° Ø 13-16 mm**
ES **Conector de 90° Ø 13-16 mm**
DE **Schlauchanschluss 90° Ø 13-16 mm**
EN **90° connector Ø 13-16 mm**

5 pz./blister
5 pcs/blister
5 St./Blister
5 pcs/blister pack

1/2", 5 x



Art.	Ø mm	Pz./St.	€	EAN
28015	13-16	12	2,40-	8 016604 280153

IT **Raccordo a T Ø 13-16 mm**
ES **Conector en forma de T Ø 13-16 mm**
DE **Schlauchanschluss T Ø 13-16 mm**
EN **T connector Ø 13-16 mm**

5 pz./blister
5 pcs/blister
5 St./Blister
5 pcs/blister pack

1/2", 5 x



Art.	Ø mm	Pz./St.	€	EAN
28016	13-16	12	2,70-	8 016604 280160



IT **Raccordo Ø 13-16 mm**
 Pratico anche come raccordo di riparazione.
ES **Conector Ø 13-16 mm**
 También práctico como accesorio de reparación.
DE **Schlauchanschluss Ø 13-16 mm**
 Auch praktisch als Reparaturanschluss.
EN **Connector Ø 13-16 mm**
 Ideal as repairing piece too.

5 pz./blister
5 pcs/blister
5 St./Blister
5 pcs/blister pack

1/2", 5 x



Art.	Ø mm	Pz./St.	€	EAN
28017	13-16	12	1,90-	8 016604 280177



IT **Giunto per raccordo portagomma Ø 13-16 mm**
ES **Junta para conector portagoma Ø 13-16 mm**
DE **Verbindungsstück für Schlauchanschluss Ø 13-16 mm**
EN **Joint for garden hose connector Ø 13-16 mm**

5 pz./blister
5 pcs/blister
5 St./Blister
5 pcs/blister pack

1/2", 5 x



Art.	Ø mm	Pz./St.	€	EAN
28018	13-16	12	3,10-	8 016604 280184



IT **Gocciolatore regolabile a 8 ugelli**
 Da installare direttamente sul tubo.
ES **Goteador regulable de 8 boquillas**
 A instalar directamente en el tubo.
DE **Einstellbarer Tropfer zu 8 Düsen**
 Soll direkt auf den Schlauch installiert werden.
EN **8 nozzle adjustable dripper**
 To be installed directly on the tube.

10 pz./blister
10 pcs/blister
10 St./Blister
10 pcs/blister pack

0-40 l/h, 10 x



Art.	lt/h	Pz./St.	€	EAN
28019	0-40	12	3,40-	8 016604 280191



IT **Valvola di chiusura Ø 13-16 mm**
ES **Válvula de cierre Ø 13-16 mm**
DE **Verschlussventil Ø 13-16 mm**
EN **Shut-off valve Ø 13-16 mm**

1 pz./blister
1 pcs/blister
1 St./Blister
1 pc/blister pack

1/2"



Art.	Ø mm	Pz./St.	€	EAN
28020	13-16	12	3,90-	8 016604 280207



IT **Gocciolatore regolabile**
 Da installare direttamente sul tubo.
ES **Goteador regulable**
 A instalar directamente en el tubo.
DE **Einstellbarer Tropfer**
 Soll direkt auf dem Schlauch installiert werden.
EN **Adjustable dripper**
 To be installed directly on the tube.

10 pz./blister
10 pcs/blister
10 St./Blister
10 pcs/blister pack

0-8 l/h, 10 x



Art.	lt/h	Pz./St.	€	EAN
28021	0-8	12	3,40-	8 016604 280214



- Picchetto per tubo Ø 13-16 mm**
- Estaca para tubo Ø 13-16 mm**
- Halterung für Schlauch Ø 13-16 mm**
- Stake for Ø 13-16 mm tube**



5 pz/blister
5 pcs/Blister
5 St./Blister
5 pcs/blister pack



Art.	Ø mm	Pz./St.	€	EAN
28022	13-16	12	3,80-	8 016604*280221



- Raccordo rubinetto Ø 13-16 mm**
- Conector grifo Ø 13-16 mm**
- Hahnanschluss Ø 13-16 mm**
- Tap connector Ø 13-16 mm**



1 pz/blister
1 pz/blister
1 St./Blister
1 pc/blister pack



Art.	Ø mm	Inch	Pz./St.	€	EAN
28024	13-16	1/2" 3/4"	12	2,20-	8 016604*280245



- Punteruolo fora-tubi**
Per realizzare i fori per i componenti da installare direttamente sul tubo.

- Punzón perfora-tubos**
Para hacer los agujeros para los componentes a instalar directamente en el tubo.

- Lochstecher**
Zum Bohren von Löchern für Komponenten, die direkt auf dem Schlauch installiert werden sollen.

- Punch for tubes**
To punch the tube in order to install the components directly on it.

1 pz/blister
1 pz/blister
1 St./Blister
1 pc/blister pack



Art.	Pz./St.	€	EAN
28026	6	1,70-	8 016604*280269



- IT** • Ideale per irrigare fino a 18 vasi.
- Compatibile con altri sistemi con Ø 4-6 mm.
- Sistema per balcone, personalizzabile e modulare.
- Ottimizza il processo di irrigazione grazie ai diversi gocciolatori inclusi.

- DE** • Ideal zur Bewässerung von bis zu 18 Töpfen.
- Kompatibel mit anderen Systemen zu Ø 4-6 mm.
- Ideal für den Balkon, personalisierbar und modular.
- Optimierte den Bewässerungsprozess dank der verschiedenen Tropfköpfe.

- EN** • Ideal for the irrigation of up to 18 vases.
- Compatible with other Ø 4-6 mm micro-irrigation systems.
- Ideal for the balcony, customizable and scalable system.
- Optimizes the irrigation process thanks to the different drippers included.

Art. 28002

- Set micro irrigazione per balcone**
Con tubo da 15 metri.

- Set microirriego para balcón**
Con tubo de 15 metros.

- Micro-Bewässerungsset für Balkon**
Mit Schlauch von 15 Meter.

- Micro irrigation set for balcony**
With 15 meters tube.



Art.	Ø mm	Pz./St.	€	EAN
28002	4-6	4	28,20-	8 016604*280023

- Tappo terminale Ø 4-6 mm**
- Tapón terminal Ø 4-6 mm**
- Abschlusskappe Ø 4-6 mm**
- Terminal cap Ø 4-6 mm**



10 pz/blister
10 pcs/Blister
10 St./Blister
10 pcs/blister pack



Art.	Ø mm	Pz./St.	€	EAN
28005	4-6	12	1,80-	8 016604*280054



- Raccordo Ø 4-6 mm**
Pratico anche come raccordo di riparazione.

- Conector Ø 4-6 mm**
También práctico como accesorio de reparación.

- Schlauchanschluss Ø 4-6 mm**
Auch praktisch als Reparaturanschluss.

- Connector Ø 4-6 mm**
Ideal as repairing piece too.



10 pz/blister
10 pcs/Blister
10 St./Blister
10 pcs/blister pack



Art.	Ø mm	Pz./St.	€	EAN
28006	4-6	12	2,00-	8 016604*280061



- Raccordo a T Ø 4-6 mm**
- Conector en forma de T Ø 4-6 mm**
- Schlauchanschluss T Ø 4-6 mm**
- T connector Ø 4-6 mm**



10 pz/blister
10 pcs/Blister
10 St./Blister
10 pcs/blister pack



Art.	Ø mm	Pz./St.	€	EAN
28007	4-6	12	2,90-	8 016604*280078



- Raccordo a 90° Ø 4-6 mm**
- Conector de 90° Ø 4-6 mm**
- Schlauchanschluss 90° Ø 4-6 mm**
- 90° connector Ø 4-6 mm**



10 pz/blister
10 pcs/Blister
10 St./Blister
10 pcs/blister pack



Art.	Ø mm	Pz./St.	€	EAN
28008	4-6	12	2,60-	8 016604*280085



- Gocciolatore regolabile**
- Goteador regulable**
- Einstellbarer Tropfer**
- Adjustable dripper**



10 pz/blister
10 pcs/Blister
10 St./Blister
10 pcs/blister pack



Art.	Ø mm	lt/h	Pz./St.	€	EAN
28009	4-6	0-6	12	7,00-	8 016604*280092

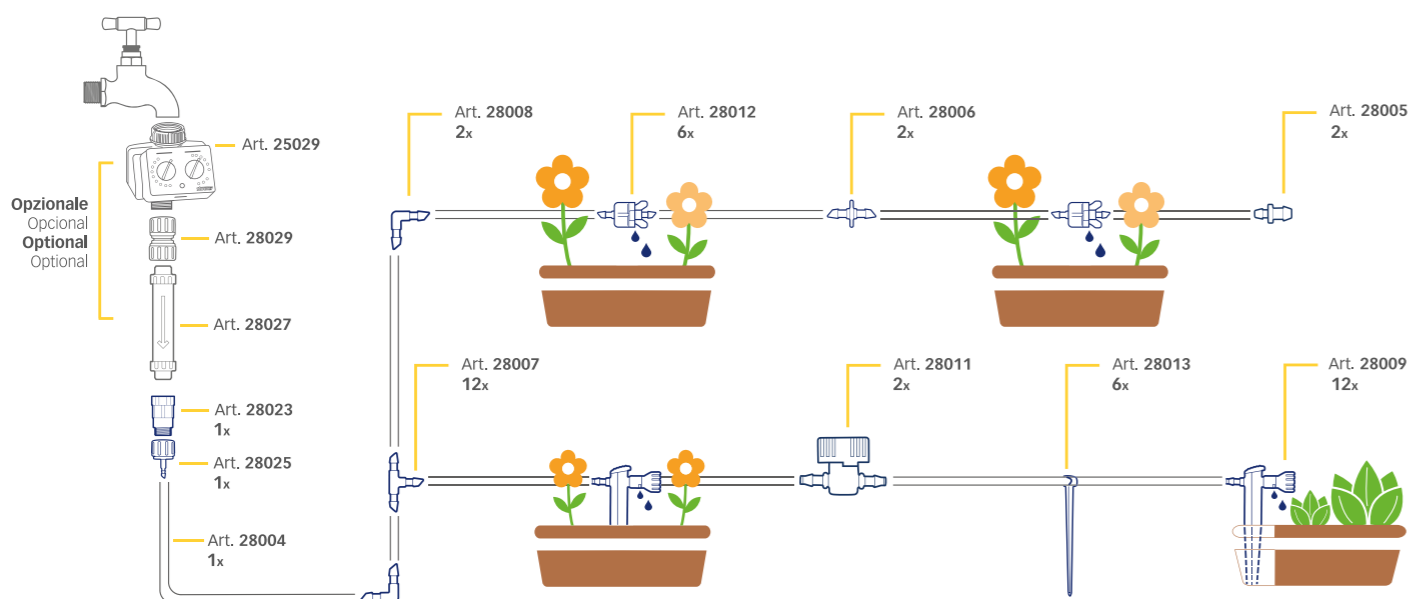

- Gocciolatore regolabile a 8 ugelli**
- Goteador regulable de 8 boquillas**
- Einstellbarer Tropfer zu 8 Düsen**
- 8 nozzle adjustable dripper**



10 pz/blister
10 pcs/blister
10 St./Blister
10 pcs/blister pack



Art.	Ø mm	lt/h	Pz./St.	€	EAN
28010	4-6	0 - 40	12	7,50-	8 016604 280108



- Valvola di chiusura Ø 4-6 mm**
- Válvula de cierre Ø 4-6 mm**
- Verschlussventil Ø 4-6 mm**
- Shut-off valve Ø 4-6 mm**



5 pz/blister
5 pcs/blister
5 St./Blister
5 pcs/blister pack



Art.	Ø mm	Pz./St.	€	EAN
28011	4-6	12	4,40-	8 016604 280115



- Gocciolatore in-line**
- Goteador in-line**
- Tropfer in-line**
- In-line dripper**



10 pz/blister
10 pcs/blister
10 St./Blister
10 pcs/blister pack



Art.	Ø mm	lt/h	Pz./St.	€	EAN
28012	4-6	5	12	4,00-	8 016604 280122



- Picchetto per tubo Ø 4-6 mm**
- Estaca para tubo Ø 4-6 mm**
- Halterung für Schlauch Ø 4-6 mm**
- Stake for Ø 4-6 mm tube**



10 pz/blister
10 pcs/blister
10 St./Blister
10 pcs/blister pack



Art.	Ø mm	Pz./St.	€	EAN
28013	4-6	12	2,20-	8 016604 280139



- Raccordo rubinetto Ø 4-6 mm**
- Conector grifo Ø 4-6 mm**
- Hahnanschluss Ø 4-6 mm**
- Tap connector Ø 4-6 mm**



1 pz/blister
1 pz/blister
1 St./Blister
1 pc/blister pack



Art.	Ø mm	Inch	Pz./St.	€	EAN
28025	4-6	1/2" 3/4"	12	2,20-	8 016604 280252



- Riduttore di pressione**
- Riduce la pressione a 1 bar.

- Reductor de presión**
- Reduce la presión a 1 bar.

- Druckreduzierer**
- Reduziert den Druck auf 1 bar.

- Pressure reducer**
- It reduces the pressure to 1 bar.



1 pz/blister
1 pz/blister
1 St./Blister
1 pc/blister pack



Art.	Inch	Pz./St.	€	EAN
28023	3/4"	6	5,90-	8 016604 280238



- Filtro piccolo**
- Previene l'intasamento per un funzionamento efficiente a lungo.

- Filtro pequeño**
- Evita la obstrucción para un funcionamiento eficiente mucho tiempo.

- Filter klein**
- Verhindert Verstopfungen für einen langfristig effizienten Einsatz.

- 3/4"**
- Small filter**
- It prevents any obstructions for a long-lasting efficiency.



Art.	Ø Inch	Pz./St.	€	EAN
28027	3/4"	6	8,50-	8 016604 280276



- Filtro grande**
- Previene l'intasamento per un funzionamento efficiente a lungo.

- Filtro grande**
- Evita la obstrucción para un funcionamiento eficiente mucho tiempo.

- Filter groß**
- Verhindert Verstopfungen für einen langfristig effizienten Einsatz.

- 3/4"**
- Big filter**
- It prevents any obstructions for a long-lasting efficiency.



Art.	Ø Inch	Pz./St.	€	EAN
28028	3/4"	6	16,70-	8 016604 280283



- Raccordo femmina doppio**
- Conector hembra doble**
- Anschluss Weibchen doppelt**
- Double female connector**



1 pz/blister
1 pz/blister
1 St./Blister
1 pc/blister pack



Art.	Ø Inch	Pz./St.	€	EAN
28029	3/4"	12	2,90-	8 016604 280290



- Tubo micro irrigazione Ø 13-16 mm**
- In polietilene. Per set micro irrigazione per orto.

- Tubo microrriego Ø 13-16 mm**
- De polietileno. Para set microrriego para huerto.

- Schlauch Ø 13-16 mm für Micro-Bewässerung**
- Aus Polyethylen. Für Micro-Bewässerungsset für Gemüsegarten.

- Micro irrigation tube Ø 13-16 mm**
- Made from polyethylene. For micro irrigation system for vegetable garden.



Art.	Ø mm	mt	Pz./St.	€	EAN
28003	13-16	25	1	13,90-	8 016604 280030



- Tubo micro irrigazione Ø 4-6 mm**
- In polietilene. Per set micro irrigazione per balcone.

- Tubo microrriego Ø 4-6 mm**
- De polietileno. Para set microrriego para balcón.

- Schlauch Ø 4-6 mm für Micro-Bewässerung**
- Aus Polyethylen. Für Micro-Bewässerungsset für Balkon.

- Micro irrigation tube Ø 4-6 mm**
- Made from polyethylene. For micro irrigation system for balcony.



Art.	Ø mm	mt	Pz./St.	€	EAN
28004	4-6	25	42	9,70-	8 016604 280047



COME COSTRUIRE L'IMPIANTO DI MICRO-IRRIGAZIONE PER L'ORTO

Uno strumento utile con guida fai-da-te per i tuoi clienti, per personalizzare il loro impianto di irrigazione.



www.stockergarden.com/video/come-irrigare-lorto-durante-le-vacanze/



Art. 25019

SET IRRIGAZIONE

SET RIEGO
BEWÄSSERUNGSSET
IRRIGATION SET

- IT** • Soluzione ideale per l'irrigazione di giardini e aiuole fino a 200 m², in base alla pressione del sistema.
- Sistema personalizzabile e modulare, compatibile con altri sistemi di irrigazione con tubo da 1/2".
- Con ciascun irrigatore è possibile irrigare con il getto circolare a 360° o impostare e direzionare a piacere un angolo d'irrigazione di ampiezza inferiore.
- ES** • Solución ideal para el riego de jardines y parterres de hasta 200 m², según la presión del sistema.
- Sistema personalizable y modular, compatible con otros sistemas de riego con tubo de 1/2".
- Con cada aspersor es posible regar con el chorro circular de 360° o configurar y dirigir un ángulo de riego de amplitud inferior según se desee.
- DE** • Ideale Lösung für die Bewässerung von Gärten und Blumenbeeten bis zu 200 m², abhängig vom Systemdruck.
- Personalisierbares und modulares System, kompatibel mit anderen Bewässerungssystemen mit einem Schlauchdurchmesser von 1/2".
- Uneingeschränkte Personalisierung durch die Möglichkeit den Sprühwinkel und die Richtung nach Belieben anzupassen.
- EN** • Ideal for irrigating gardens or flowerbeds of up to 200 m², depending on the system's pressure.
- Customizable and scalable system, compatible with other irrigation systems with 1/2" hose.
- With each sprinkler it is possible to irrigate with a 360° circular jet or to choose a smaller spraying-angle.

5
BAR

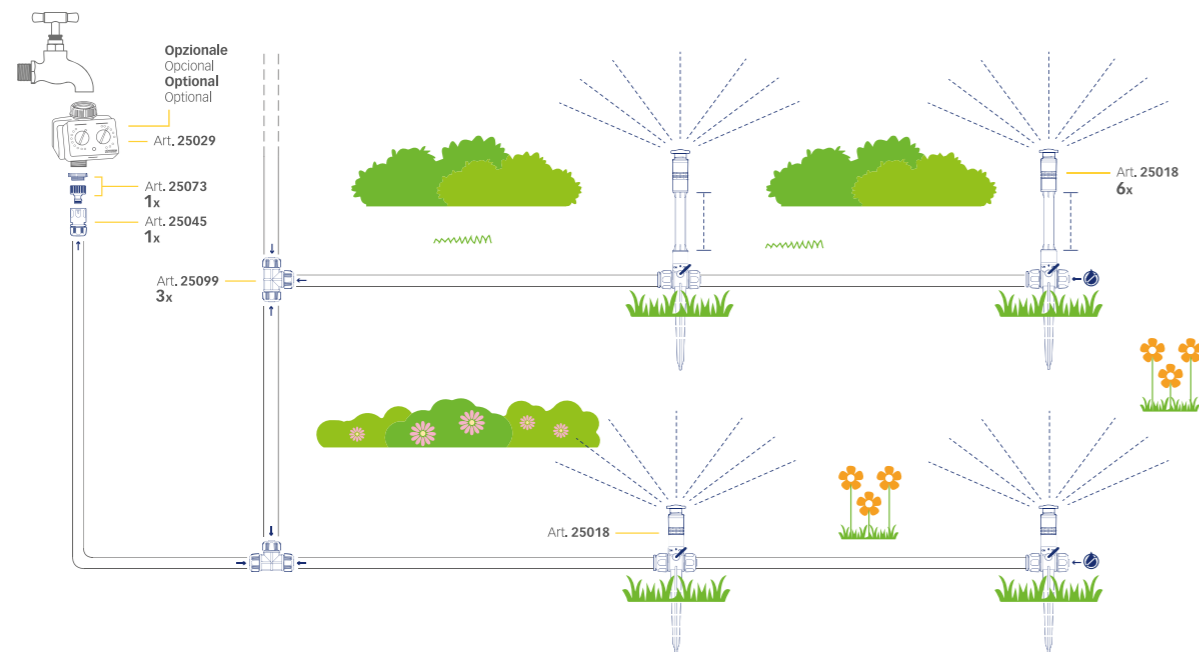

Set irrigazione

Consente di risparmiare il tempo per l'irrigazione manuale e ridurre lo spreco di acqua. Massima flessibilità grazie alla valvola di regolazione o chiusura del flusso d'acqua su ogni irrigatore. Ideale in combinazione con water timer (non incluso). Pressione d'esercizio ottimale: 5 bar. Completo di tubo in pvc da 15 metri.

Set riego

Permite ahorrar el tiempo para el riego manual y reduce el desperdicio de agua. Máxima flexibilidad gracias a la válvula para regular o cerrar el caudal de agua en cada aspersor. Ideal en combinación con temporizador de agua (no incluido). Presión de trabajo óptima: 5 bar. Completo con tubo de pvc de 15 metros.

Bewässerungsset

Spart Zeit für die manuelle Bewässerung und reduziert die Wasserver-schwendung. Maximale Flexibilität dank des regulierbaren Wasserdurchflusses und des Absperrventils an jedem Sprühregner. Ideal in Kombination mit dem Wassertimer (nicht im Lieferumfang enthalten). Optimaler Druck: 5 Bar. Komplet mit PVC-Schlauch zu 15 Metern.

Irrigation set

In comparison to manual irrigation, this system is time-saving and reduces the waste of water. Maximum flexibility thanks to the flow regulation or closure valve on every sprinkler. Best combined with a water timer (not included). Optimal operating pressure: 5 bar. Complete with a 15 meters pvc tube.



* fino ad esaurimento
* hasta agotamiento
* solange der Vorrat reicht
* While supplies last

Art.	Ø mm/Inch	m ²	Pz./St.	€	EAN
25019	12,5 / 1/2"	200 m ²	2	96,50-	8 016604 250194



RACCORDI

CONECTORES
ARMATUREN
GARDEN HOSE VALVES

143

Art. 25098

- ✓ Raccordo rubinetto
- ✚ Conector grifo
- ☞ Hahnanschluss
- ☑ Tap connector



1/2"
3/4"



- ✓ Display raccordo rubinetto
- ✚ Expositor conector grifo
- ☞ Display Hahnanschluss
- ☑ Display tap connector



1/2"
3/4"



Art.	Inch	Pz./St.	€	EAN
25073	1/2" 3/4"	10	2,30-	8 016604 250736

Art.	Inch	Pz./St.	€	EAN
25073/S	1/2" 3/4"	60	2,30-	8 016604 250743

- ✓ Raccordo rubinetto universale
- ✚ Conector grifo universal
- ☞ Universal-Hahnanschluss
- ☑ Universal tap connector



1"
3/4"



- ✓ Display raccordo rubinetto
- ✚ Expositor conector grifo
- ☞ Display Hahnanschluss
- ☑ Display tap connector



1"
3/4"



Art.	Inch	Pz./St.	€	EAN
25075	1" 3/4"	10	2,60-	8 016604 250750

Art.	Inch	Pz./St.	€	EAN
25075/S	1" 3/4"	60	2,60-	8 016604 250767

- ✓ Raccordo rubinetto
- ✚ Conector grifo
- ☞ Hahnanschluss
- ☑ Tap connector



3/4"



- ✓ Display raccordo rubinetto
- ✚ Expositor conector grifo
- ☞ Display Hahnanschluss
- ☑ Display tap connector



3/4"



Art.	Inch	Pz./St.	€	EAN
25070	3/4"	10	1,30-	8 016604 250705

Art.	Inch	Pz./St.	€	EAN
25070/S	3/4"	60	1,30-	8 016604 250712

- ✓ Giunto
- In plastica.
- ✚ Junta
- De plástico.
- ☞ Verbindungsstück
- In Kunststoff.
- ☑ Extension joint
- Made of plastic.



- ✓ Raccordo rubinetto
- Con filettatura esterna, in plastica.
- ✚ Conector grifo
- Con rosca externa, de plástico.
- ☞ Hahnanschluss
- Mit Außengewinde, in Kunststoff.
- ☑ Tap connector
- With external screw thread, made of plastic.



3/4"



Art.	Inch	Pz./St.	€	EAN
25080		10	1,70-	8 016604 250804

Art.	Inch	Pz./St.	€	EAN
25085	3/4"	10	1,30-	8 016604 250859

- ✓ Deviatore a Y
- Per dirigere il flusso in 2 direzioni.
- ✚ Desviador con forma de Y
- Para dirigir el flujo en dos direcciones.
- ☞ Y-Verbinder
- Um den Durchfluss in 2 Richtungen zu lenken.
- ☑ Y hose Connector
- To split the water flow into two.



- ✓ Raccordo rubinetto con filtro
- ✚ Conector grifo con filtro
- ☞ Hahnanschluss mit Filter
- ☑ Tap connector with filter



1"
3/4"
1/2"



Art.	Inch	Pz./St.	€	EAN
25090		10	2,30-	8 016604 250903

Art.	Inch	Pz./St.	€	EAN
25094	1" 3/4" 1/2"	10	10,40-	8 016604 250941

- ✓ Raccordo portagomma Acquastop DELUXE
- ✚ Conector portagoma Acquastop DELUXE
- ☞ Schlauchanschluss DELUXE Wasserstop
- ☑ Hose connector Waterstop DELUXE



1/2"
5/8"
3/4"



- ✓ Display raccordo portagomma DELUXE
- ✚ Expositor conector portagoma DELUXE
- ☞ Display Schlauchanschluss DELUXE Wasserstop
- ☑ Display hose connector DELUXE



1/2"
5/8"
3/4"



Art.	Inch	Pz./St.	€	EAN
27048	1/2" 5/8" 3/4"	10	5,20-	8 016604 270482

Art.	Inch	Pz./St.	€	EAN
27048/S	1/2" 5/8" 3/4"	30	5,20-	8 016604 270499

BESTSELLER



- ✓ Raccordo portagomma DELUXE
- ✚ Conector portagoma DELUXE
- ☞ Schlauchanschluss DELUXE
- ☑ Hose connector DELUXE

1/2"
5/8"
3/4"



Art.	Inch	Pz./St.	€	EAN
27045	1/2" 5/8" 3/4"	10	4,90-	8 016604 270451

- ✓ Raccordo di riparazione DELUXE
- ✚ Conector de reparación DELUXE
- ☞ Reparaturstück DELUXE
- ☑ Fixing connector DELUXE



1/2"
5/8"
3/4"



Art.	Inch	Pz./St.	€	EAN
27050	1/2" 5/8" 3/4"	10	4,90-	8 016604 270505

- ✓ Raccordo a T
- ✚ Conector en forma de T
- ☞ Schlauchanschluss T
- ☑ T connector



1/2"

Art.	Inch	Pz./St.	€	EAN
25099	1/2"	10	3,30-	8 016604 250996

- ✓ Display raccordo portagomma DELUXE
- ✚ Expositor conector portagoma DELUXE
- ☞ Display Schlauchanschluss DELUXE
- ☑ Display hose connector DELUXE



1/2"
5/8"
3/4"



Art.	Inch	Pz./St.	€	EAN
27045/S	1/2" 5/8" 3/4"	30	4,90-	8 016604 270468

- ✓ Display raccordo riparazione DELUXE
- ✚ Expositor conector reparación DELUXE
- ☞ Display Reparaturstück DELUXE
- ☑ Display Fixing connector DELUXE



1/2"
5/8"
3/4"



Art.	Inch	Pz./St.	€	EAN
27050/S	1/2" 5/8" 3/4"	30	4,90-	8 016604 270512

- ✓ Regolatore Aquastop DELUXE
- ✚ Regulador Aquastop DELUXE
- ☞ Regulierstopp Wasserstopp DELUXE
- ☑ Adjustable hose connector Waterstop DELUXE



1/2"

Art.	Inch	Pz./St.	€	EAN
27046	1/2"	10	6,60-	8 016604 270437

- ✓ Universal-Set DELUXE

Comprende i seguenti articoli: 27034, 25073, 27045, 27048.

- ✚ Universal-Set DELUXE

Incluye los siguientes artículos: 27034, 25073, 27045, 27048.

- ☞ Universal-Set DELUXE

Enthält folgende Artikel: 27034, 25073, 27045, 27048.

- ☑ Universal set DELUXE

Includes the following items: 27034, 25073, 27045, 27048.

- ✓ Set lancia e raccordi

Comprende i seguenti articoli: 25033, 25073, 25048, 25045.

- ✚ Set lanza y conectores

Incluye los siguientes artículos: 25033, 25073, 25048, 25045.

- ☞ Set Spritze und Schlauchanschluss

Enthält die folgenden Artikel: 25033, 25073, 25048, 25045.

- ☑ Set lance and connectors

Includes the following items: 25033, 25073, 25048, 25045.



1/2"
5/8"
3/4"



Art.	Inch	Pz./St.	€	EAN
27040	1/2" 5/8" 3/4"	10	15,00-	8 016604 270406



1/2"

Art.	Inch	Pz./St.	€	EAN
25040	1/2"	10	9,30-	8 016604 250408

Raccordo portagomma
 Conector portagoma
 Schnell-Schlauchanschluss
 Hose connector



1/2"

Art.	Inch	Pz./St.	€	EAN
25045	1/2"	10	3,00-	8 016604 250453

Display raccordo portagomma
 Expositor conector portagoma
 Display Schnell-Schlauchanschluss
 Display hose connector



1/2"

Art.	Inch	Pz./St.	€	EAN
25045/S	1/2"	40	3,00-	8 016604 250460

Raccordo portagomma Aquastop
 Conector portagoma Aquastop
 Schnell-Schlauchanschluss Wasserstopp
 Hose connector Waterstop



1/2"



Art.	Inch	Pz./St.	€	EAN
25048	1/2"	10	3,10-	8 016604 250484

Display raccordo portagomma Aquastop
 Expositor conector portagoma Aquastop
 Display Schnell-Schlauchanschluss Wasserstopp
 Display hose connector Waterstop



1/2"



Art.	Inch	Pz./St.	€	EAN
25048/S	1/2"	40	3,10-	8 016604 250491

Raccordo di riparazione
 Conector de reparación
 Reparaturstück
 Fixing connector



1/2"

Art.	Inch	Pz./St.	€	EAN
25050	1/2"	10	2,20-	8 016604 250507

Display raccordo riparazione
 Expositor conector reparación
 Display Reparaturstück
 Display fixing connector



1/2"

Art.	Inch	Pz./St.	€	EAN
25050/S	1/2"	40	2,20-	8 016604 250514

Raccordo portagomma
 Conector portagoma
 Schnell-Schlauchanschluss
 Hose connector



5/8" 3/4"

Art.	Inch	Pz./St.	€	EAN
25055	5/8" 3/4"	10	3,10-	8 016604 250552

Display raccordo portagomma
 Expositor conector portagoma
 Display Schnell-Schlauchanschluss
 Display hose connector



5/8" 3/4"

Art.	Inch	Pz./St.	€	EAN
25055/S	5/8" 3/4"	30	3,10-	8 016604 250545

Raccordo portagomma Acquastop
 Conector portagoma Acquastop
 Schnell-Schlauchanschluss Wasserstopp
 Hose connector Waterstop



5/8" 3/4"



Art.	Inch	Pz./St.	€	EAN
25056	5/8" 3/4"	10	3,20-	8 016604 250569

Display raccordo portagomma Acquastop
 Expositor conector portagoma Acquastop
 Display Schnell-Schlauchanschluss Wasserstopp
 Display hose connector Waterstop



5/8" 3/4"



Art.	Inch	Pz./St.	€	EAN
25056/S	5/8" 3/4"	30	3,20-	8 016604 250576

Raccordo di riparazione
 Conector de reparación
 Reparaturstück
 Fixing connector



5/8" 3/4"

Art.	Inch	Pz./St.	€	EAN
25065	5/8" 3/4"	10	3,20-	8 016604 250651

Display raccordo riparazione
 Expositor conector reparación
 Display Reparaturstück
 Display fixing connector



5/8" 3/4"

Art.	Inch	Pz./St.	€	EAN
25065/S	5/8" 3/4"	30	3,20-	8 016604 250668

Raccordo rubinetto Anti Torsion
 Evita l'attorcigliamento del tubo da giardino grazie all'attacco snodabile a 360°.

Conector grifo Anti Torsion
 Evita el retorcimiento de la manguera de jardín gracias a la conexión articulada de 360°.

Hahnanschluss Anti Torsion
 360° drehbarer Anschluss vermeidet das Knicken und Verdrehen des Schlauches.

Anti Torsion tap connector
 It avoids the torsion of the garden hose thanks to the 360° twisting connection.

Raccordo rubinetto Anti Torsion multifunzione
 Evita l'attorcigliamento del tubo da giardino grazie all'attacco snodabile a 360°. Pratica doccia lava-mani, con due diversi tipi di getto.

Conector grifo Anti Torsion multifunción
 Evita el retorcimiento de la manguera de jardín gracias a la conexión articulada de 360°. Práctica ducha lavamanos, con dos tipos diferentes de chorro.

Multifunktions-Hahnanschluss Anti Torsion
 360° drehbarer Anschluss vermeidet das Knicken und Verdrehen des Schlauches. Praktische Handwaschbrause mit zwei verschiedenen Strahlformen.

Multifunction Anti Torsion tap connector
 It avoids the torsion of the garden hose thanks to the 360° twisting connection. Quick hand-washing function with two different streams.

Raccordo rubinetto a 2 uscite
 2 uscite regolabili separatamente in continuo.

Conector grifo con 2 salidas
 Unión de plástico con 2 salidas regulables por separado.

2-Wege-Hahnanschluss
 Zum Benützen von 2 Anschlussgeräten. Mit 2 regulierbaren Ausgängen.

2 way tap connector
 Used for the connection of two hoses with tap connectors (or for the use of 2 port devices). With two adjustable outputs.

Raccordo rubinetto a 4 uscite
 4 uscite regolabili separatamente in continuo.

Conector grifo con 4 salidas
 Unión de plástico con 4 salidas regulables por separado.

4-Wege-Hahnanschluss
 Zum Benützen von 4 Anschlussgeräten. Mit 4 regulierbaren Ausgängen.

4 way tap connector
 For the use of 4 port devices. With 4 adjustable outputs.

Set O-ring
 Per tutti i raccordi a innesto rapido.

O-Rings
 Para todos los conectores con acople rápido.

O-Ringe
 Ersatzteil für Verbindungsstücke.

O-Rings
 Spare parts for connectors.

Guarnizione piatta
 Per presa rubinetto.

Junta plana
 Para toma de grifo.

Gummidichtung flach
 Für Hahnanschluss.

Flat washer
 For tap connection.



Art.	Inch	Pz./St.	€	EAN
25097	1" 3/4" 1/2"	6	6,60-	8 016604 250972



Art.	Inch	Pz./St.	€	EAN
25098	1" 3/4" 1/2"	6	15,90-	8 016604 250989



Art.	Inch	Pz./St.	€	EAN
25092	1" 3/4"	12	9,30-	8 016604 250927



Art.	Inch	Pz./St.	€	EAN
25096	1" 3/4"	12	18,80-	8 016604 250965



Art.	Inch	Pz./St.	€	EAN
25100		10	3,00-	8 016604 251009



Art.	Inch	Pz./St.	€	EAN
25105	3/4"	10	4,90-	8 016604 251054

stocker

www.stocker.com



LANCE

**LANZAS
BRAUSEN
SPRINKLER HEADS**

Art. 27217

147

Pistola a spruzzo regolabile
 Pistola de pulverización regulable
 Gießpistole mit regulierbarem Jetstrahl
 Adjustable spray gun





Art.	cm	Gr.	Pz./St.	€	EAN
27213	26	265	10	20,80-	8 016604 272134

Pistola a spruzzo regolabile
 Pistola de pulverización regulable
 Gießpistole mit regulierbarem Jetstrahl
 Adjustable spray gun





Art.	cm	Gr.	Pz./St.	€	EAN
26213	20,5	310	10	23,10-	8 016604 262135

Pistola a spruzzo regolabile
 Pistola de pulverización regulable
 Gießpistole mit regulierbarem Jetstrahl
 Adjustable spray gun



Art.	cm	Gr.	Pz./St.	€	EAN
25211	20	145	10	8,90-	8 016604 252112

Lancia speciale
 Lanza especial
 Spezial-Lanze
 Special lance



Art.	cm	Gr.	Pz./St.	€	EAN
27219	20	230	10	16,40-	8 016604 272196

Lancia a spruzzo regolabile
 Lanza de pulverización regulable
 Regulierbare Spritze
 Adjustable spray lance



Art.	cm	Gr.	Pz./St.	€	EAN
25033	14,5	40	10	3,00-	8 016604 250330

Display lancia a spruzzo regolabile
 Expositor lanza de pulverización regulable
 Display regulierbare Spritze
 Display adjustable spray lance



Art.	cm	Gr.	Pz./St.	€	EAN
25033/S			30	3,00-	8 016604 250347

Lancia a spruzzo regolabile DELUXE
 Lanza de pulverización regulable DELUXE
 Regulierbare Spritze DELUXE
 Adjustable spray lance DELUXE



Art.	cm	Gr.	Pz./St.	€	EAN
27034	15	65	10	8,20-	8 016604 270345

Lancia multiuso
 Lanza multiuso
 Multifunktions-Lanze
 Multifunction lance





Art.	cm	Gr.	Pz./St.	€	EAN
27210	21	285	10	19,20-	8 016604 272103

Pistola a doccia multiuso
 Pistola de ducha multiuso
 Multifunktions-Brause
 Multifunction spray gun





Art.	cm	Gr.	Pz./St.	€	EAN
27214	21	275	10	22,30-	8 016604 272141

Pistola a doccia multiuso
 Pistola de ducha multiuso
 Multifunktions-Brause
 Multifunction spray gun



Art.	cm	Gr.	Pz./St.	€	EAN
25212	22	175	10	9,90-	8 016604 252129

Pistola a spruzzo regolabile TWIST
 Pistola de pulverización regulable TWIST
 Regulierbare Gießpistole TWIST
 Adjustable spray gun TWIST





Art.	cm	Gr.	Pz./St.	€	EAN
27215	18	240	10	23,60-	8 016604 272158

Pistola a spruzzo regolabile TWIST
 Pistola de pulverización regulable TWIST
 Regulierbare Gießpistole TWIST
 Adjustable spray gun TWIST







Art.	cm	Gr.	Pz./St.	€	EAN
27216	18	230	10	24,20-	8 016604 272165

Pistola a doccia multiuso TWIST
 Getto a spirale ideale per la pulizia profonda di superfici. Impugnatura ergonomica.

Pistola de ducha multiuso TWIST
 Chorro en espiral ideal para la limpieza profunda de superficies. Empuñadura ergonómica.

Multifunktions-Brause TWIST
 Twist-Spiralstrahl für eine effiziente Oberflächenreinigung. Ergonomischer Komfortgriff.

Multifunction spray gun TWIST
 The twister jet is ideal for thoroughly cleaning surfaces. Comfortable, ergonomic handle.

Art.	cm	Gr.	Pz./St.	€	EAN
27217	19,5	305	10	27,50-	8 016604 272172

Universal-Set DELUXE
 Universal-Set DELUXE
 Universal-Set DELUXE
 Universal set DELUXE





Art.	Inch	Pz./St.	€	EAN
27040	1/2" 5/8" 3/4"	10	15,00-	8 016604 270406

Set lancia e raccordi
 Set lanza y conectores
 Set Spritze und Schlauchanschluss
 Set lance and connectors





Art.	Inch	Pz./St.	€	EAN
25040	1/2"	10	9,30-	8 016604 250408

Pistola a doccia multiuso
 In alluminio e plastica. Dispone di 7 differenti forme di getto e regolazione del flusso d'acqua.

Pistola de ducha multiuso
 De aluminio y plástico. Cuenta con 7 diferentes formas de chorro y regulación del flujo de agua.

Multifunktions-Brause
 Aus Aluminium und Kunststoff. Diese Brause verfügt über 7 verschiedene Formen der Strahl- und Wasserdurchflussregulierung.

Multifunction spray gun
 Made of aluminium and plastic. With 7 different water jet modes and jet regulation.

Art.	cm	Gr.	Pz./St.	€	EAN
26214	20	325	10	24,80-	8 016604 262142

Lancia in alluminio a doccia
 Lanza de aluminio de ducha
 Gießbrause in Aluminium
 Aluminium spray lance

50 cm	95 cm	FUNCTIONS icon	ALU icon
-------	-------	----------------	----------



Art.	cm	Gr.	Pz./St.	€	EAN
26203	50	410	12	31,70-	8 016604 262036
26209	95	470	12	34,00-	8 016604 262098

Lancia in alluminio a doccia
 Lanza de aluminio de ducha
 Gießstab in Aluminium
 Aluminium spray lance

46 cm	94 cm	FUNCTIONS icon	ALU icon
-------	-------	----------------	----------

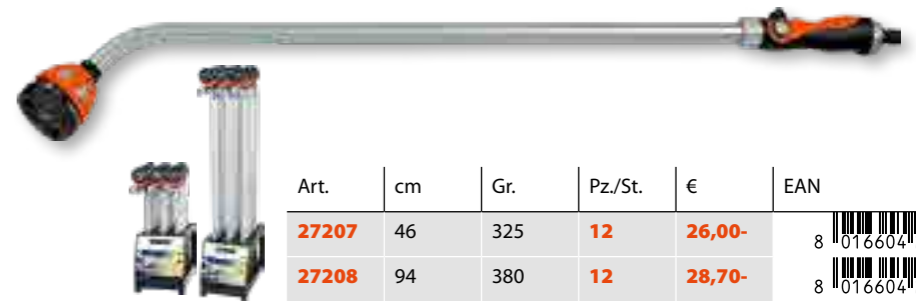

Art.	cm	Gr.	Pz./St.	€	EAN
27207	46	325	12	26,00-	8 016604 272073
27208	94	380	12	28,70-	8 016604 272080

Lancia in alluminio a doccia
 Lanza de aluminio de ducha
 Gießbrause in Aluminium
 Aluminium spray lance

45 cm	92 cm	ALU icon
-------	-------	----------



Art.	cm	Gr.	Pz./St.	€	EAN
26201	45	215	6	17,50-	8 016604 262012
26202	92	280	6	22,20-	8 016604 262029

stocker

www.stockergarden.com



IRRIGATORI

ASPERSORES
REGNER
SPRINKLERS

Art. 25018

152



Irrigatore a spruzzo
Ideale per superfici di massimo 100 m².

Aspersor de pulverización
Ideal para superficies de hasta 100 m².

Sprühregner
Ideal für Flächen bis zu 100 m².

Sprinkler
Ideal for areas not larger than 100 m².



Irrigatore multitestina
Dispone di 8 ugelli che permettono di ottenere 8 forme diverse di getto.

Aspersor con función múltiple
Dispone de 8 boquillas que permiten obtener 8 formas diferentes de chorro.

Sprühregner mit Mehrfachfunktion
Verfügt über 8 Düsen welche 8 verschiedene Strahlformen ermöglichen.

Multifunction sprinkler
With 8 different nozzles that allow for 8 different water jet modes.



Art.	m	Gr.	Pz./St.	€	EAN
25001	8	70	12	6,10-	8 016604 250019

Art.	m	Gr.	Pz./St.	€	EAN
26021	10	150	12	9,00-	8 016604 260216



Jet-Spray 360°
Dispone di 5 forme diverse di getto.

Jet-spray 360°
Cuenta con 5 formas diferentes de chorro.

Jet-Spray 360°
Es hat 5 verschiedene Strahlformen.

Jet-Spray 360°
With 5 different water jet modes.



Jet-spray 360°
Con regolazione di 5 forme diverse di getto. Con base in metallo per una maggiore stabilità.

Jet-spray 360°
Con regulación de 5 formas diferentes de chorro. Con base metálica para una mejor estabilidad.

Jet-Spray 360°
Mit 5 verschiedenen Sprühformen und Metallbasis.

Jet-spray 360°
5 different spray patterns and a metal base.

* fino ad esaurimento
* hasta agotamiento
* solange der Vorrat reicht
* While supplies last



Art.	m	Gr.	Pz./St.	€	EAN
25005	15	280	6	26,10-	8 016604 250057

Art.	m	Gr.	Pz./St.	€	EAN
25006	15	545	6	45,70-	8 016604 250064



Irrigatore a girandola regolabile
Tre braccetti rotanti con 4 ugelli ciascuno più 3 ugelli centrali. Direzione del getto regolabile di 45°.

Aspersor de molinete regulable
Tres brazos rotativos con 4 boquillas cada uno y 3 boquillas centrales. Dirección del chorro ajustable a 45°.

Regulierbarer Kreisregner
Drei-Arm-Kreisregner mit 4 Düsen pro Arm und 3 weiteren zentralen Düsen. Strahlrichtung um 45° einstellbar.

Adjustable rotary sprinkler
Three rotary arms with 4 nozzles each and 3 additional central nozzles. 45° adjustable spraying.



Art.	m	Gr.	Pz./St.	€	EAN
25002	5	228	6	14,60-	8 016604 250026



Irrigatore oscillante
18 ugelli in ottone garantiscono una perfetta emissione del getto.

Aspersor oscilante
18 boquillas garantizan una perfecta emisión del chorro.

Regner mit Schwingvorrichtung
18 Präzisions-Messingdüsen sorgen für eine perfekte Wasserverteilung.

Swinging sprinkler
18 precision brass nozzles distribute the water accurately.



Art.	m ²	Pz./St.	€	EAN
26031	120 - 260 m ²	6	53,60-	8 016604 260315



Irrigatore oscillante
18 ugelli in ottone garantiscono una perfetta emissione del getto.

Aspersor oscilante
18 boquillas garantizan una perfecta emisión del chorro.

Regner mit Schwingvorrichtung
Über 18 Präzisions-Messingdüsen wird das Wasser perfekt verteilt.

Swinging sprinkler
18 precision brass nozzles distribute the water accurately.



Art.	m ²	Pz./St.	€	EAN
26034	120 - 260 m ²	6	27,40-	8 016604 260346



Irrigatore oscillante
15 ugelli di precisione in plastica per una distribuzione perfetta dell'acqua.

Aspersor oscilante
Con 15 boquillas de precisión de plástico el agua se distribuye perfectamente.

Regner mit Schwingvorrichtung
Über 15 Präzisions-Kunststoffdüsen wird das Wasser perfekt verteilt.

Swinging sprinkler
15 precision plastic nozzles distribute the water accurately.



Art.	m ²	Pz./St.	€	EAN
25014	180 m ²	12	19,00-	8 016604 250149



Irrigatore multifunzione
Dispone di 5 forme diverse di getto.

Aspersor multifuncional
Cuenta con 5 formas diferentes de chorro.

Sprühregner mit Mehrfachfunktion
Verfügt über 5 verschiedene Strahlformen.

Multifunction sprinkler
With 5 different water jet modes.



Art.	m	Gr.	Pz./St.	€	EAN
25009	10		12	6,80-	8 016604 250095



Irrigatore a settore
Aspersor sectorial
Sektorenregner
Zone sprinkler



Art.	m	Pz./St.	€	EAN
25008	20	10	6,60-	8 016604 250088



Irrigatore a settore
Aspersor sectorial
Sektorenregner
Zone sprinkler



Art.	m	Pz./St.	€	EAN
26010	20	10	32,20-	8 016604 260100

Irrigatore a spruzzo 360° regolabile

È possibile irrigare con il getto a 360° o impostare e direzionare un angolo d'irrigazione di ampiezza inferiore. Con prolunga per alzare il punto di spruzzo.

Aspersor de pulverización 360° regulable

Es posible regar con el chorro de 360° o configurar y dirigir un ángulo de riego de amplitud inferior. Extensión incluida para elevar el punto de pulverización.

Regulierbarer 360° Sprühregner

Uneingeschränkte Personalisierung durch die Möglichkeit den Sprühwinkel und die Richtung nach Belieben anzupassen. Höhenverstellbarer Sprühkopf durch mitgelieferte Verlängerung.

Adjustable 360° sprinkler

It is possible to irrigate with a 360° jet or to choose and set the direction of a smaller spraying angle. Extension for raising the spraying point included.



Irrigatore a spruzzo 360° regolabile

È possibile irrigare con il getto a 360° o impostare e direzionare un angolo d'irrigazione di ampiezza inferiore. Con prolunga per alzare il punto di spruzzo. Ideale da usare in una linea di irrigazione.

Aspersor de pulverización 360° regulable

Es posible regar con el chorro de 360° o configurar y dirigir un ángulo de riego de amplitud inferior. Extensión incluida para elevar el punto de pulverización. Ideal para usar en una línea de riego.

Regulierbarer 360° Sprühregner

Uneingeschränkte Personalisierung durch die Möglichkeit den Sprühwinkel und die Richtung nach Belieben anzupassen. Höhenverstellbarer Sprühkopf durch mitgelieferte Verlängerung. Einfache Erweiterung mit anderen Sprühregnern.

Adjustable 360° sprinkler

It is possible to irrigate with a 360° jet or to choose and set the direction of a smaller spraying angle. Extension for raising the spraying point included. Ideal to be used in an irrigation line.



* fino ad esaurimento
* hasta agotamiento
* solange der Vorrat reicht
* While supplies last

Art.	m	Gr.	Pz./St.	€	EAN
25017	5	100	6	12,40-	8 016604 250170

Art.	m	Gr.	Pz./St.	€	EAN
25018	5	90	6	12,00-	8 016604 250187

Irrigatore treppiede a settore

Aspersor trípode sectorial

Dreifuß Sektorenregner

Tripod zone sprinkler

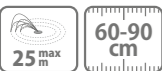

Art.	h cm	Pz./St.	€	EAN
26015	60 - 90 cm	9	65,40-	8 016604 260155

Set irrigazione

Consente di risparmiare il tempo per l'irrigazione manuale e ridurre lo spreco di acqua. Massima flessibilità grazie alla valvola di regolazione o chiusura del flusso d'acqua su ogni irrigatore. Ideale in combinazione con water timer (non incluso). Pressione d'esercizio ottimale: 5 bar. Completo di tubo in pvc da 15 metri. Più informazioni a pagina 152.

Set riego

Permite ahorrar el tiempo para el riego manual y reduce el desperdicio de agua. Máxima flexibilidad gracias a la válvula para regular o cerrar el caudal de agua en cada aspersor. Ideal en combinación con temporizador de agua (no incluido). Presión de trabajo óptima: 5 bar. Completo con tubo de pvc de 15 metros. Más informaciones en la página 152.

Bewässerungsset

Spart Zeit für die manuelle Bewässerung und reduziert die Wasserverschwendung. Maximale Flexibilität dank des regulierbaren Wasserdurchflusses und des Absperrventils an jedem Sprühregner. Ideal in Kombination mit dem Wassertimer (nicht im Lieferumfang enthalten). Optimaler Druck: 5 Bar. Komplett mit PVC-Schlauch zu 15 Metern. Weitere Informationen auf Seite 152.

Irrigation set

In comparison to manual irrigation, this system is time-saving and reduces the waste of water. Maximum flexibility thanks to the flow regulation or closure valve on every sprinkler. Best combined with a water timer (not included).



Optimal operating pressure: 5 bar. Complete with a 15 meters pvc tube. More information on page 152.



* fino ad esaurimento
* hasta agotamiento
* solange der Vorrat reicht
* While supplies last

Art.	Ø mm/Inch	m²	Pz./St.	€	EAN
25019	12,5 / 1/2"	200 m²	2	96,50-	8 016604 250194

Wassertimer manuale

• Irrigazione AUTOMATICA
• PROGRAMMABILE: durata del ciclo: 1, 3, 5, 10, 15, 20, 30, 60, 90, 120 minuti
• Funziona con batteria alcalina 9V (non inclusa)
• Minimo 0,5 bar
• Massimo 12 bar

Temporizador de riego manual

• Riego AUTOMÁTICO
• PROGRAMABLE: Duración del ciclo: 1, 3, 5, 10, 15, 20, 30, 60, 90, 120 minutos
• Funciona con batería alcalina 9V (no incluida)
• Mínimo 0,5 bar
• Máximo 12 bar

Wassertimer manuell

• AUTOMATISCHE Bewässerung
• PROGRAMMIERBAR: Bewässerungsdauer: 1, 3, 5, 10, 15, 20, 30, 60, 90, 120 Minuten
• Erforderliche Batterie: 9V Alkaline Batterie (nicht enthalten)
• Minimum 0,5 Bar
• Maximum 12 Bar

Manual wassertimer

• AUTOMATIC irrigation
• PROGRAMMABLE: cycle time: 1, 3, 5, 10, 15, 20, 30, 60, 90, 120 minutes
• required battery: 9V alkaline (not included)
• minimum 0.5 bar
• maximum 12 bar



Art.	cm	Gr.	Pz./St.	€	EAN
25029			9	55,30-	8 016604 250293

Wassertimer digitale

• Irrigazione AUTOMATICA a due zone
• PROGRAMMABILE: irrigazione separata ed indipendente di due zone differenti. Frequenza (1, 2, 3, 4, 6, 8, 12 ore, 1-7 giorni)
• Funziona con batteria alcalina 9V (non inclusa)
• Minimo 0,5 bar • Massimo 8 bar

Temporizador de riego digital

• Riego AUTOMÁTICO para dos zonas
• PROGRAMABLE: Riego separado e independiente de dos zonas diferentes. Frecuencia (1, 2, 3, 4, 6, 8, 12 horas, 1-7 días)
• Funciona con batería alcalina 9V (no incluida)
• Mínimo 0,5 bar • Máximo 8 bar

Wassertimer digital

• AUTOMATISCHE Bewässerung von zwei Zonen
• PROGRAMMIERBAR: Zwei unabhängig voneinander programmierbare Zonen. Frequenz (1, 2, 3, 4, 6, 8, 12 Stunden, 1-7 Tage)
• Erforderliche Batterie: 1 x 9V Alkaline (nicht enthalten)
• Minimum 0,5 Bar • Maximum 8 Bar

Digital wassertimer

• AUTOMATIC: for the irrigation of two zones
• PROGRAMMABLE: two independently programmed zones. Frequency (1, 2, 3, 4, 6, 8, 12 hours, 1-7 days)
• required Battery: 1 x 9V alkaline (not included)
• minimum 0.5 bar • maximum 8 bar



Art.	cm	Gr.	Pz./St.	€	EAN
25027			9	97,80-	8 016604 250279

Wassertimer digitale

• Irrigazione AUTOMATICA
• PROGRAMMABILE: durata del ciclo (1-199 minuti). Frequenza (1, 2, 3, 4, 6, 8, 12 ore, 1-7 giorni)
• Funziona con batteria alcalina 9V (non inclusa)
• Minimo 0,5 bar • Massimo 12 bar

Temporizador de riego digital

• Riego AUTOMÁTICO
• PROGRAMABLE: Duración del ciclo (1-199 minutos). Frecuencia (1, 2, 3, 4, 6, 8, 12 horas, 1-7 días)
• Funciona con batería alcalina 9V (no incluida)
• Mínimo 0,5 bar • Máximo 12 bar

Wassertimer digital

• AUTOMATISCHE Bewässerung
• PROGRAMMIERBAR: Dauer (1-199 Minuten). Frequenz (1, 2, 3, 4, 6, 8, 12 Stunden, 1-7 Tage)
• Erforderliche Batterie: 1 x 9V Alkaline (nicht enthalten)
• Minimum 0,5 Bar • Maximum 12 Bar

Digital wassertimer

• AUTOMATIC: for the irrigation of two zones
• PROGRAMMABLE: two independently programmed zones. Frequency (1, 2, 3, 4, 6, 8, 12 hours, 1-7 days)
• required battery: 1 x 9V alkaline (not included)
• minimum 0.5 bar • maximum 8 bar



Art.	cm	Gr.	Pz./St.	€	EAN
25028			9	71,30-	8 016604 250286

☑ Watertimer manuale
Per disattivare automaticamente l'irrigazione dopo una durata da 5 a 120 minuti.

☑ Temporizador de riego manual
Para desactivar automáticamente el riego después de una duración de 5 a 120 minutos.

☑ Watertimer manuell
Start-/Abschaltautomatik einstellbar von 5 bis 120 Minuten.

☑ Manual watertimer
Adjustable starter, with an automatic switch after 5-120 minutes.



Art.	cm	Gr.	Pz./St.	€	EAN
25025			12	26,60-	8 016604 250255

☑ Watertimer manuale
A due zone.
Per disattivare automaticamente l'irrigazione dopo una durata da 5 a 120 minuti.

☑ Temporizador de riego manual
2 zonas. Para desactivar automáticamente el riego después de una duración de 5 a 120 minutos.

☑ Watertimer manuell
Start-/Abschaltautomatik einstellbar von 5 bis 120 Minuten.

☑ Manual watertimer
For 2 areas. Adjustable starter, with an automatic switch after 5-120 minutes.



* fino ad esaurimento
* hasta agotamiento
* solange der Vorrat reicht
* While supplies last

Art.	cm	Gr.	Pz./St.	€	EAN
25026			10	45,50-	8 016604 250262

☑ Avvolgitubo
Connettore del tubo angolato che ne impedisce l'attorcigliamento.

☑ Portamanguera
La conexión de manguera angulada impide un torcimiento de la manguera.

☑ Schlauchhalter
Abgewinkelter Schlauchanschluss verhindert das Abknicken des Schlauches.

☑ Hose reel
The angled hose connector prevents the kinking of the hose.



Art.	cm	Gr.	Pz./St.	€	EAN
25060			4	36,50-	8 016604 250606

☑ Carrello avvolgitubo
Maniglia regolabile in altezza.

☑ Carro portamanguera
Con manija ajustable en altura.

☑ Schlauchwagen
Mit höhenverstellbarem Handgriff.

☑ Trolley hose reel
With a height-adjustable handle.



Art.	cm	Gr.	Pz./St.	€	EAN
25062			4	47,50-	8 016604 250620

☑ Set avvolgitubo MINI
Comprensivo di tubo da 8 metri e pistola a doccia.

☑ Set Portamanguera MINI
Incluye tubo de 8 metros y pistola de ducha.

☑ Set Schlauchhalter MINI
Inklusive 8-Meter-Schlauch und Gießbrause.

☑ MINI hose reel
It includes a 8 meters hose and a spray gun.



Art.	cm	Gr.	Pz./St.	€	EAN
26067			4	28,40-	8 016604 260674

☑ Portatubo a parete
Fino a 35 m di tubo da 1/2".

☑ Portamanguera de pared
Hasta 35 m de tubo de 1/2".

☑ Wand-Schlauchhalter
Für bis zu 35 m 1/2" Schlauch.

☑ Garden hose wall hanger
For up to 35 meters of 1/2" hose.



Art.	cm	Gr.	Pz./St.	€	EAN
26084			10	4,60-	8 016604 260841





Art.	Ø mm/Inch	mt	bar	Pz./St.	€	EAN
27070	12,5 / 1/2"	25	27	1	31,45-	8 016604270703
27071	12,5 / 1/2"	50	27	1	59,30-	8 016604270710
27072	19 / 3/4"	25	24	1	58,50-	8 016604270727
27073	19 / 3/4"	50	24	1	109,50-	8 016604270734
27074	15 / 5/8"	15	27	1	23,80-	8 016604270741
27075	15 / 5/8"	25	27	1	39,65-	8 016604270758
27076	15 / 5/8"	50	27	1	74,70-	8 016604270765
27069	25 / 1"	25	21	1	92,70-	8 016604270697



☑ Tubo Tornio Anti Torsion
Con rinforzo magliato Anti Torsione in poliestere ad alta tenacità. Temperatura d'esercizio: -10°C/+60°C. Anti-alga e anti UV.

☑ Tubo Tornio Anti Torsion
Con refuerzo mallado Anti Torsión en poliéster de alta tenacidad. Temperatura de trabajo: -10°C/+60°C. Anti-algas y anti UV.

☑ Gartenschlauch Tornio Anti Torsion
Verstärkt mit „Anti Torsion“-Strickgewebe aus reißfestem Polyester. Temperaturbeständigkeit: -10°C/+60°C. Algen- und UV-beständig.

☑ Torsion anti-torsion garden hose
High tenacity knitted „Anti Torsion“ polyester reinforcement. Temperature resistance: -10°C/+60°C. Anti-algae and UV resistant.



Art.	Ø mm/Inch	mt	bar	Pz./St.	€	EAN
27077	12,5 / 1/2"	25	45	1	37,70-	8 016604270772
27078	12,5 / 1/2"	50	45	1	71,00-	8 016604270789
27079	19 / 3/4"	25	30	1	70,40-	8 016604270796
27080	19 / 3/4"	50	30	1	131,50-	8 016604270802
27081	15 / 5/8"	15	40	1	29,65-	8 016604270819
27082	15 / 5/8"	25	40	1	49,65-	8 016604270826
27083	15 / 5/8"	50	40	1	93,70-	8 016604270833



☑ Tubo Eos Anti Torsion
Tubo a 6 strati. Con doppio rinforzo combinato magliato e retinato in poliestere ad alta tenacità. Temperatura d'esercizio: -10°C/+60°C. Anti-alga e anti UV. La superficie esterna è realizzata con PVC metallizzato "Soft Touch".

☑ Tubo Eos Anti Torsion
Tubo con 6 estratos. Con doble refuerzo mallado y tejido en poliéster de alta tenacidad. Temperatura de trabajo: -10°C/+60°C. Anti-algas y anti UV. La superficie exterior está realizada con PVC metalizado "Soft Touch".

☑ Gartenschlauch Eos Anti Torsion
6-lagig. Doppelgeweebeeinlage (Kreuz- und Strickgewebe) aus reißfestem Polyester. Temperaturbeständigkeit: -10°C/+60°C. Algen- und UV-beständig. Schlauchmantel aus metallisiertem „Soft Touch“-PVC.

☑ Eos anti-torsion garden hose
6 layers. Double combined braided and knitted high tenacity polyester reinforcement. Temperature resistance: -10°C/+60°C. Anti-algae and UV resistant. The outer layer of the hose is made of metallized „Soft Touch“ PVC.



Art.	Ø mm/Inch	mt	bar	Pz./St.	€	EAN
27084	12,5 / 1/2"	15	40	1	13,55-	8 016604270840
27085	12,5 / 1/2"	25	40	1	22,55-	8 016604270857
27086	15 / 5/8"	15	36	1	15,25-	8 016604270864
27087	15 / 5/8"	25	36	1	25,30-	8 016604270871
27088	25 / 1"	25	21	1	59,10-	8 016604270888



☑ Tubo Vera
Tubo in PVC a tre strati con rinforzo retinato in poliestere ad alta tenacità. Temperatura d'esercizio: -5°C/+50°C. Anti-alga.

☑ Tubo Vera
Manguera en PVC con tres capas y refuerzo tejido en poliéster de alta tenacidad. Temperatura de trabajo: -5°C/+50°C. Anti-algas.

☑ Gartenschlauch Vera
Dreilagiger PVC-Gartenschlauch mit Kreuzgeweebeeinlage aus reißfestem Polyester. Temperaturbeständigkeit: -5°C/+50°C. Algenbeständig.

☑ Vera garden hose
Three layers PVC garden hose with high tenacity polyester reinforcement. Temperature resistance: -5°C/+50°C. Anti-algae.

☑ Tubo poroso 20 m, 1/2"
Il tubo poroso trasuda acqua dalle pareti. Completo di 1 raccordo portagomma 1/2", 1 raccordo portagomma 1/2" acqua-stop e 1 riduttore di pressione.

☑ Tubo poroso 20 m, 1/2"
Este tubo basa su riego en la exudación de agua de sus paredes. Set completo con 1 conector de 1/2", 1 conector agua-stop de 1/2" y 1 reductor de presión.

☑ Sickerschlauch 20 m, 1/2"
Poröser Schlauch aus dem über die gesamte Schlauchdecke Wasser sickert. Komplett mit 1 Schlauchschnellanschluss 1/2", 1 Schlauchschnellanschluss 1/2" Wasserstopp und 1 Druckregler.

☑ Soaker hose 20 m, 1/2"
Water exudes from the surface of the hose. Complete with a rapid hose connector, 1/2" rapid hose connector, 1/2" water stopper, 1 pressure regulator.



Art.	Ø mm (")	m	Pz./St.	€	EAN
26170	12,5 mm (1/2")	20	10	28,10-	8 016604261701



☑ Tubo gocciolante per irrigazione 25 m, 1/2"
Tubo in polietilene dotato di gocciolatori interni a labirinto da 2 litri/ora, posizionati ogni 33 cm.

☑ Tubo de riego por goteo 25 m, 1/2"
Tubo de polietileno con goteros interiores a laberinto de 2 litros/hora, ubicados cada 33 cm.

☑ Tropfschlauch zur Bewässerung 25 m, 1/2"
Rohr aus Polyethylen, ausgestattet mit fest installierten Tropfern im Abstand von 33 cm. Wasserfluss 2 Liter/Stunde.



Art.	Ø mm (")	m	Pz./St.	€	EAN
26085	12,5 mm (1/2")	25	1	21,85-	8 016604260858



☑ Soaker hose 25 m, 1/2"
Pipe made of polyethylene, equipped with fixed drippers, installed at a 33 cm distance. Water flow of 2 liters per hour.

☑ Tubo micro irrigazione Ø 13-16 mm
In polietilene. Per set micro irrigazione per orto. Compatibile con altri sistemi di micro irrigazione da Ø 13-16 mm. Pressione massima di esercizio: 4 bar.

☑ Tubo microrriego Ø 13-16 mm
De polietileno. Para set microrriego para huerto. Compatible con otros sistemas de microrriego de Ø 13-16 mm. Presión máxima: 4 bar.

☑ Schlauch Ø 13-16 mm für Micro-Bewässerung
Aus Polyethylen. Für Micro-Bewässerungssysteme für Gemüsegarten. Kompatibel mit anderen Micro-Bewässerungssystemen von Ø 13-16 mm. Maximaler Druck: 4 bar.

☑ Micro irrigation tube Ø 13-16 mm
Made from polyethylene. For micro irrigation system for vegetable garden. Compatible with other Ø 13-16 mm micro-irrigation systems. Max. operating pressure: 4 bar.



Art.	Ø mm	mt	Pz./St.	€	EAN
28003	13-16	25	1	13,90-	8 016604280030



☑ Tubo micro irrigazione Ø 4-6 mm
In polietilene. Per set micro irrigazione per balcone. Compatibile con altri sistemi di micro irrigazione da Ø 4-6 mm. Pressione massima di esercizio: 4 bar.

☑ Tubo microrriego Ø 4-6 mm
De polietileno. Para set microrriego para balcón. Compatible con otros sistemas de microrriego de Ø 4-6 mm. Presión máxima: 4 bar.

☑ Schlauch Ø 4-6 mm für Micro-Bewässerung
Aus Polyethylen. Für Micro-Bewässerungssysteme für Balkon. Kompatibel mit anderen Micro-Bewässerungssystemen von Ø 4-6 mm. Maximaler Druck: 4 bar.

☑ Micro irrigation tube Ø 4-6 mm
Made from polyethylene. For micro irrigation system for balcony. Compatible with other Ø 4-6 mm micro-irrigation systems. Max. operating pressure: 4 bar.



Art.	Ø mm	mt	Pz./St.	€	EAN
28004	4-6	25	42	9,70-	8 016604280047



stocker

www.stockergarden.com



ATTREZZI

HERRAMIENTAS
GARTENWERKZEUGE
GARDEN TOOLS

Art. 2476

166



- Manico intercambiabile
- Mango intercambiable
- Austauschbarer Stiel
- Interchangeable handle

Art.	cm	Gr.	Pz./St.	€	EAN
2018	80	384	12	8,00-	8 016604 200496



- Piantatore regolabile
- Plantador regulable
- Automatik-Pflanzer
- Adjustable planter

Art.	cm	Gr.	Pz./St.	€	EAN
2027	23,5	262	12	8,70-	8 016604 020278



- Zappetta a cuore bidente
- Azada binadora en forma de corazón
- Herzförmige Hacke
- 2-teeth heart-shaped hoe

Art.	cm	Gr.	Pz./St.	€	EAN
2000	31	226	12	8,50-	8 016604 200557



- Zappetta quadrata bidente
- Azada cuadrada binadora
- Kombihacke viereckig
- 2-teeth small squared hoe

Art.	cm	Gr.	Pz./St.	€	EAN
2040	31	250	12	8,80-	8 016604 200533



- Paletta larga
- Pala ancha
- Kelle breit
- Wide shovel

Art.	cm	Gr.	Pz./St.	€	EAN
2002	33	240	12	7,10-	8 016604 200519



- Paletta stretta
- Pala estrecha
- Kelle gerade
- Thin shovel

Art.	cm	Gr.	Pz./St.	€	EAN
2004	32	174	12	6,90-	8 016604 200564



- Rastrellino
- Rastrillo
- Kleinrechen
- Small rake

Art.	cm	Gr.	Pz./St.	€	EAN
2012	31	212	12	7,40-	8 016604 200571



- Estirpatore
- Extirpador
- Unkrautstecher
- Weeder

Art.	cm	Gr.	Pz./St.	€	EAN
2044	36,5	186	12	6,90-	8 016604 200434



- Coltivatore
- Cultivador
- Kultivator
- Weeder

Art.	cm	Gr.	Pz./St.	€	EAN
2042	42	244	12	7,30-	8 016604 201554



- Sarchiello
- Cultivador
- Kleingrubber
- Weeder

Art.	cm	Gr.	Pz./St.	€	EAN
2038	42	230	12	8,00-	8 016604 201509



- Scopetta Denti rotondi.
- Escobilla Dientes redondos.
- Kleinfächer-Besen Runde Zinken.
- Hand rake Round teeth.

Art.	cm	Gr.	Pz./St.	€	EAN
2036	42,5	212	12	7,30-	8 016604 200632



- Scopetta Denti piatti.
- Escobilla Dientes planos.
- Kleinfächer-Besen Flache Zinken.
- Hand rake Flat teeth.

Art.	cm	Gr.	Pz./St.	€	EAN
2037	38	186	12	7,30-	8 016604 200601



- Piantatoio
- Plantador
- Pflanzer
- Planter

Art.	cm	Gr.	Pz./St.	€	EAN
2026	35	234	12	7,40-	8 016604 020261



- Zappetta a cuore bidente
- Azada binadora en forma de corazón
- Herzförmige Doppelhacke
- 2-teeth heart-shaped hoe

Art.	cm	*140 cm	Pz./St.	€	EAN
2260			4	13,60-	8 016604 022609
2202			12	8,80-	8 016604 022029

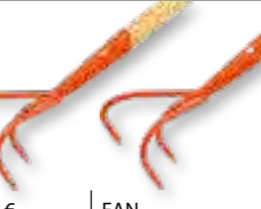

- Coltivatore
- Cultivador
- Kultivator
- Weeder

Art.	cm	*140 cm	Pz./St.	€	EAN
2262			4	13,10-	8 016604 022623
2204			12	6,90-	8 016604 022043



- Rastrello a 10 denti
- Rastrillo de 10 dientes
- Rechen mit 10 Zinken
- 10-teeth rake

Art.	cm	*140 cm	denti/dientes	Pz./St.	€	EAN
2264	25		10	4	13,50-	8 016604 022647
2205	25		10	12	7,40-	8 016604 022050



- Rastrello a 14 denti
- Rastrillo de 14 dientes
- Rechen mit 14 Zinken
- 14-teeth rake

Art.	cm	*140 cm	denti/dientes	Pz./St.	€	EAN
2266	35		14	4	16,80-	8 016604 022661
2207	35		14	12	10,20-	8 016604 022074



- Paletta In alluminio.
- Pala De aluminio.
- Gartenkelle In Aluminium.
- Small shovel In aluminum.

Art.	cm	Gr.	Pz./St.	€	EAN
2016	29	206	12	10,60-	8 016604 020162



- Zappetta quadrata bidente
- Azada cuadrada binadora
- Kombihacke viereckig
- 2-teeth squared hoe

Art.	cm	*140 cm	Pz./St.	€	EAN
2261			4	13,30-	8 016604 022616
2203			12	8,70-	8 016604 022036

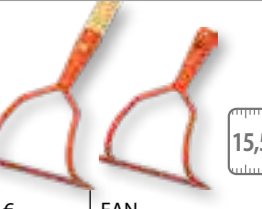

- Sarchiatore Larghezza 15,5 cm.
- Escardilla Ancho 15,5 cm.
- Bügeljäter Breite 15,5 cm.
- Weeder Width 15.5 cm.

Art.	cm	*140 cm	Pz./St.	€	EAN
2263	15,5		4	20,00-	8 016604 022630
2213	15,5		12	12,40-	8 016604 022135



- Rastrello a 12 denti
- Rastrillo de 12 dientes
- Rechen mit 12 Zinken
- 12-teeth rake

Art.	cm	*140 cm	denti/dientes	Pz./St.	€	EAN
2265	30		12	4	15,60-	8 016604 022654
2206	30		12	12	8,90-	8 016604 022067

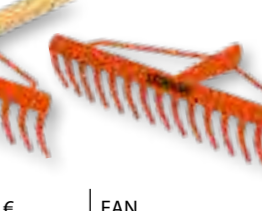

- Rastrello a 16 denti
- Rastrillo de 16 dientes
- Rechen mit 16 Zinken
- 16-teeth rake

Art.	cm	*140 cm	denti/dientes	Pz./St.	€	EAN
2267	40		16	4	19,00-	8 016604 022678
2209	40		16	12	11,50-	8 016604 022098



Rastrello per erba
 Rastrillo para hierba
 Raseenrechen
 Rake



Art.	cm	denti/dientes	Pz./St.	€	EAN
2217	52	32	10	23,20-	8 016604 022173

Rastrello areatore
 Rastrillo aireador
 Rasenlüfter
 Lawn areator rake



Art.	cm	lame/cuchillas	Pz./St.	€	EAN
2216	40	12	4	54,80-	8 016604 022166

Rastrello areatore
 Rastrillo aireador
 Rasenlüfter
 Lawn areator rake



Art.	cm	denti/dientes	Pz./St.	€	EAN
2215	34	21/11	10	29,50-	8 016604 022159

Coglifrutta
 Recolector de fruta
 Obstpflücker
 Fruit picker



Art.	Ø cm	Gr.	Pz./St.	€	EAN
2208	14		12	8,20-	8 016604 022081

Rastrello per foglie
 Senza manico.
 Rastrillo para follaje
 Sin mango.
 Laubrechen
 Ohne Stiel.
 Fan rake
 Without handle.



Art.	cm	denti/dientes	Pz./St.	€	EAN
2031	44	22	12	16,80-	8 016604 020315

Rastrello per foglie
 Con 22 denti regolabili, senza manico.
 Rastrillo para follaje
 Con 22 dientes regulables, sin mango.
 Fächerbesen für Laub
 22 verstellbare Zinken, ohne Stiel.
 Fan rake
 22 adjustable teeth, without handle.



Art.	cm	denti/dientes	Pz./St.	€	EAN
2033	22	22	12	15,20-	8 016604 020339

Manico in legno
 Mango de madera
 Holzstiel
 Wooden handle

* Per/para/für/for Art. 2217, 2216, 2215, 2208, 2031, 2033, 2201, 2034



Art.	mt	Ø mm	Pz./St.	€	EAN
2218*	1,8 mt	28 mm	12	7,10-	8 016604 022180
2200*	1,5 mt	26 mm	12	5,70-	8 016604 022005
2210*	1,4 mt	26 mm	12	5,50-	8 016604 022104

Scopa per erba e foglie
 Con manico in legno. Larghezza 58 cm.
 Escoba para hierba y follaje
 Con mango de madera. Ancho 58 cm.
 Gras- und Laubbesen Mit Holzstiel. Breite 58 cm.
 Fan rake With wooden handle. Width 58 cm.

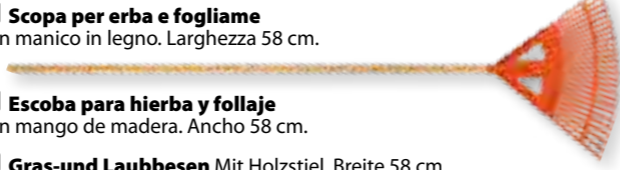

Art.	cm	denti/dientes	Pz./St.	€	EAN
2227	182	27	12	18,10-	8 016604 022272

Rastrello per foglie
 Senza manico.
 Rastrillo para follaje
 Sin mango.
 Laubrechen
 Ohne Stiel.
 Fan rake
 Without handle.



Art.	denti/dientes	Pz./St.	€	EAN
2201	22	12	12,60-	8 016604 022012

Rastrello per foglie
 Dentatura regolabile, senza manico.
 Rastrillo para follaje
 Dentadura regulable, sin mango.
 Fächerbesen für Laub
 Verstellbare Zinken, ohne Stiel.
 Fan rake
 Adjustable teeth, without handle.



Art.	denti/dientes	Pz./St.	€	EAN
2034	22	12	15,80-	8 016604 020346

Espositore per rastrelli
 Con manico in legno Art. 2210. (24 pz x Art. 2201)
 Expositor para rastrillos
 Con mango de madera Art. 2010. (24 pzs x art. 2201)
 Display für Laubbesen
 Mit Holzstiel Art. 2210. (24 St. x Art. 2201)
 Display for rakes
 With wooden handle Art. 2210. (24 pcs x Art. 2201)



Art.	cm	Pz./St.	€	EAN
2257	140	24	17,10-	8 016604 022579

Espositore per rastrelli
 Con manico in legno Art. 2210. (24 pz x Art. 2034)
 Expositor para rastrillos
 Con mango de madera Art. 2010. (24 pzs x art. 2034)
 Display mit Fächerbesen
 Mit Holzstiel Art. 2210. (24 St. x Art. 2034)
 Display for rakes
 With wooden handle Art. 2210. (24 pcs x Art. 2034)



Art.	cm	Pz./St.	€	EAN
2281	140	24	18,40-	8 016604 022814

Rastrello per foglie
 Modello con manico in alluminio.
 Rastrillo para follaje
 Modelo con mango de aluminio.
 Fächerbesen für Laub Mit Aluminium-Stiel.
 Fan rake With an aluminium handle.

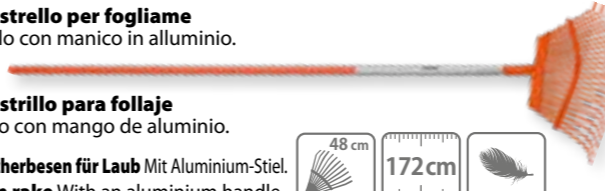

Art.	cm	denti/dientes	Pz./St.	€	EAN
2020	172	25	6	32,10-	8 016604 020209

Scopa per erba
 Con manico in legno. Larghezza 38 cm.
 Escoba para hierba
 Con mango de madera. Ancho 38 cm.
 Grasbesen Mit Holzstiel. Breite 38 cm.
 Lawn rake With a wooden handle. Width 38 cm.

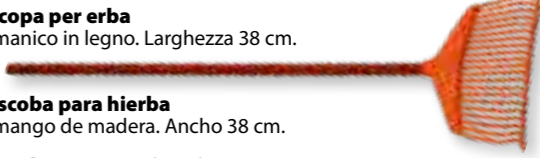

Art.	cm	denti/dientes	Pz./St.	€	EAN
2021	165	21	12	22,10-	8 016604 020216

Rastrello per foglie
 Denti regolabili, con manico telescopico in alluminio.
 Rastrillo para follaje
 Dientes regulables, con mango telescópico de aluminio.
 Laubrechen
 Mit Aluminium-Teleskopstiel und verstellbaren Zinken.
 Fan rake
 With an adjustable telescopic aluminium handle and adjustable teeth.



Art.	cm	denti/dientes	Pz./St.	€	EAN
2030	136-170	15	12	26,80-	8 016604 020308

BESTSELLER

Rastrello per foglie
 Denti regolabili, con manico telescopico.
 Rastrillo para follaje
 Dientes regulables, con mango telescópico.
 Fächerbesen
 Mit Teleskop-Stiel und verstellbaren Zinken.
 Fan rake
 With telescopic handle and adjustable teeth.



Art.	cm	denti/dientes	Pz./St.	€	EAN
2029	128-160	15	12	17,40-	8 016604 020292

Espositore per rastrelli
 (24 pz x Art. 2029)
 Expositor para rastrillos
 (24 pzs x art. 2029)
 Display für Fächerbesen
 (24 St. x Art. 2029)
 Display for rakes
 (24 pcs x Art. 2029)



Art.	cm	Pz./St.	€	EAN
2269	128-160	24	17,20-	8 016604 022692



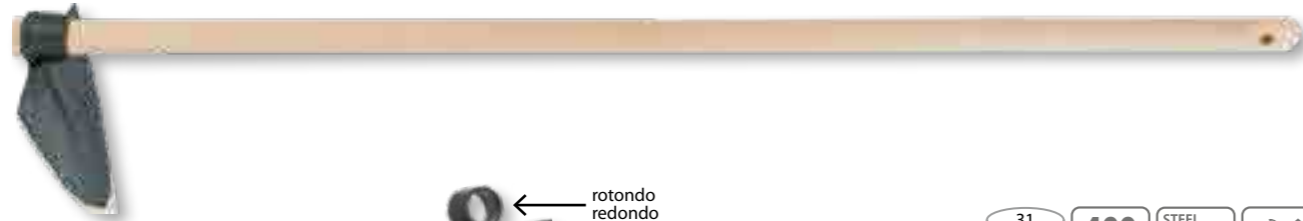

- ✓ **Zappa a cuore 400 g**
- ES **Azada en forma de corazón 400 g**
- DE **Herzförmige Hacke 400 g**
- EN **Heart-shaped hoe 400 g**



Art.	Gr.	*130 cm	Pz./St.	€	EAN
2482	942		4	14,05-	8 016604 024825
2282	400		12	8,50-	8 016604 022821



400 gr



- ✓ **Zappa a cuore 600 g**
- ES **Azada en forma de corazón 600 g**
- DE **Herzförmige Hacke 600 g**
- EN **Heart-shaped hoe 600 g**



Art.	Gr.	*130 cm	Pz./St.	€	EAN
2483	1238		4	15,85-	8 016604 024832
2283	600		12	10,20-	8 016604 022838



600 gr



- ✓ **Zappa a cuore 800 g**
- ES **Azada en forma de corazón 800 g**
- DE **Herzförmige Hacke 800 g**
- EN **Heart-shaped hoe 800 g**



Art.	Gr.	*130 cm	Pz./St.	€	EAN
2484	1630		4	17,35-	8 016604 024849
2284	800		12	11,40-	8 016604 022845



800 gr



- ✓ **Zappa a cuore 1000 g**
- ES **Azada en forma de corazón 1000 g**
- DE **Herzförmige Hacke 1000 g**
- EN **Heart-shaped hoe 1000 g**

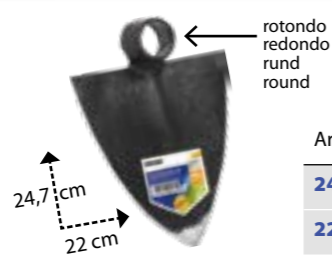

Art.	Gr.	*130 cm	Pz./St.	€	EAN
2485	1950		4	18,75-	8 016604 024856
2285	1000		12	12,75-	8 016604 022852



1000 gr



- ✓ **Manico in legno 1,3 m**
- ES **Mango de madera 1,3 m**
- DE **Holzstiel 1,3 m**
- EN **Wooden handle 1,3 m**

Art.	cm	Gr.	Pz./St.	€	EAN
2214*	130 cm	542	12	5,90-	8 016604 022142
2222*	130 cm	830	12	6,25-	8 016604 022227
2223*	130 cm	638	12	6,00-	8 016604 022234

* 2214: Per/para/für/for Art. 2270, 2274, 2275, 2282, 2288, 2289, 2470, 2474, 2475, 2482, 2488, 2489
 * 2222: Per/para/für/for Art. 2272, 2273, 2284, 2285, 2472, 2473, 2484, 2485
 * 2223: Per/para/für/for Art. 2271, 2283, 2471, 2483

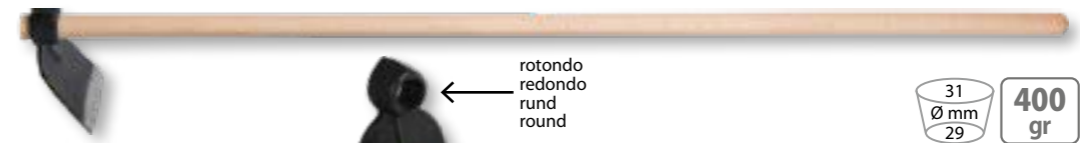

- ✓ **Zappa occhio tondo 400 g**
- ES **Azada ojo redondo 400 g**
- DE **Hacke Auge rund 400 g**
- EN **Round eye hoe 400 g**



Art.	Gr.	*130 cm	Pz./St.	€	EAN
2470	942		4	14,45-	8 016604 024702
2270	400		12	9,00-	8 016604 022708



400 gr

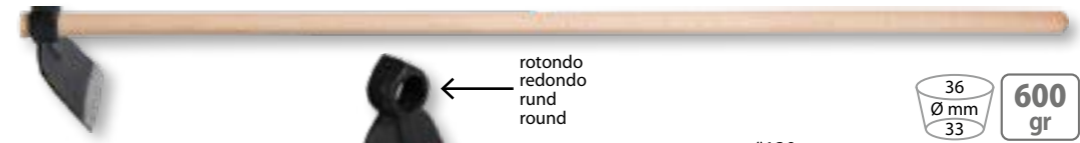

- ✓ **Zappa occhio tondo 600 g**
- ES **Azada ojo redondo 600 g**
- DE **Hacke Auge rund 600 g**
- EN **Round eye hoe 600 g**

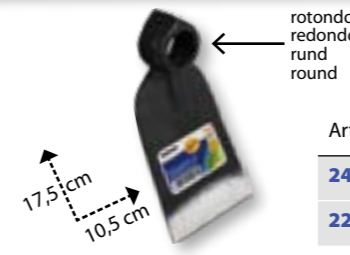

Art.	Gr.	*130 cm	Pz./St.	€	EAN
2471	1238		4	15,35-	8 016604 024719
2271	600		12	9,45-	8 016604 022715



600 gr



- ✓ **Zappa occhio tondo 800 g**
In acciaio forgiato e con manico in legno da 130 cm.
- ES **Azada ojo redondo 800 g**
De acero forjado y con mango de madera de 130 cm.
- DE **Hacke Auge rund 800 g**
Aus geschmiedetem Stahl und mit 130 cm Holzgriff.
- EN **Round eye hoe 800 g**
In forged steel with wooden-handle of 130 cm.



Art.	Gr.	*130 cm	Pz./St.	€	EAN
2472	1630		4	16,65-	8 016604 024726
2272	800		12	10,65-	8 016604 022722



800 gr



- ✓ **Espositore per zappa 800 g**
Con manico in legno. (24 pz x Art. 2472)
- ES **Expositor para azada 800 g**
Con mango de madera. (24 pzs x art. 2472)
- DE **Display für Hacken 800 g**
Mit Holzstiel. (24 St. x Art. 2472)
- EN **Display for hoes 800 g**
With wooden handle. (24 pcs for item 2472)



Art.	Gr.	*130 cm	Pz./St.	€	EAN
2248	1630		24	15,80-	

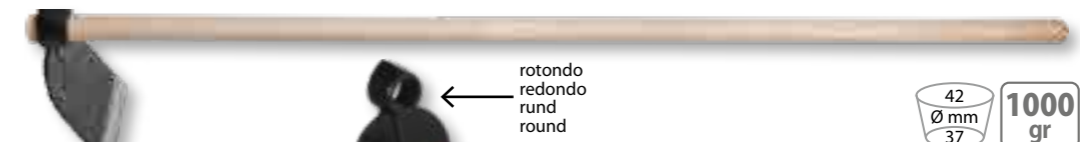

- ✓ **Zappa occhio tondo 1000 g**
- ES **Azada ojo redondo 1000 g**
- DE **Hacke Auge rund 1000 g**
- EN **Round eye hoe 1000 g**



Art.	Gr.	*130 cm	Pz./St.	€	EAN
2473	1830		4	17,55-	8 016604 024733
2273	1000		12	11,55-	8 016604 022739



1000 gr





rotondo
redondo
rund
round

28,2 cm
7 cm

500 gr STEEL

Art.	Gr.	*130 cm	Pz./St.	€	EAN
2474	1042		4	14,95-	8 016604 024740
2274	500		12	9,25-	8 016604 022746

32
Ø mm
29

Zappa bidente 500 g
 Azada binadora 500 g
 Doppelhacke 500 g
 2-teeth hoe 500 g



rotondo
redondo
rund
round

31 cm
7,5 cm

600 gr STEEL

Art.	Gr.	*130 cm	Pz./St.	€	EAN
2475	1142		4	15,95-	8 016604 024757
2275	600		12	10,20-	8 016604 022753

32
Ø mm
29

Zappa bidente 600 g
 Azada binadora 600 g
 Doppelhacke 600 g
 2-teeth hoe 600 g



600 gr STEEL

Art.	cm	Pz./St.	€	EAN	
2247	1142		24	15,20-	

Espositore per zappa 600 g
 Con manico in legno. (24 pz x Art. 2475)
 Expositor para azada 600 g
 Con mango de madera. (24 pzs x art. 2475)
 Display für Hacke 600 g
 Mit Holzstiel. (24 St. x Art. 2475)
 Display for hoes 600 g
 With wooden handle. (24 pcs for item 2475)



rotondo
redondo
rund
round

28,8 cm
8 cm

500 gr STEEL

Art.	Gr.	*130 cm	Pz./St.	€	EAN
2488	1042		4	14,40-	8 016604 024887
2288	500		12	8,75-	8 016604 022883

31
Ø mm
29

Zappa a cuore bidente 500 g
 Azada binadora en forma de corazón 500 g
 Herzförmige Doppelhacke 500 g
 Heart-shaped 2-teeth hoe 500 g



rotondo
redondo
rund
round

28,8 cm
8 cm

600 gr STEEL

Art.	Gr.	*130 cm	Pz./St.	€	EAN
2489	1142		4	15,00-	8 016604 024894
2289	600		12	9,35-	8 016604 022890

31
Ø mm
29

Zappa a cuore bidente 600 g
 Azada binadora en forma de corazón 600 g
 Herzförmige Doppelhacke 600 g
 Heart-shaped 2-teeth hoe 600 g



38x51
Ø mm
34x49

1500 gr STEEL

Art.	Gr.	*100 cm	Pz./St.	€	EAN
2476	2194		4	17,35-	8 016604 024764
2276	1500		6	11,80-	8 016604 022760

49,5 cm
5,4 cm

Piccone in acciaio 1,5 kg
 Pico de acero 1,5 kg
 Spitzhacke 1,5 kg
 Steel pick 1,5 kg



Art.	Gr.	*170 cm	Pz./St.	€	EAN
2492	1670		4	17,80-	8 016604 024924
2292	700		12	12,60-	8 016604 022920

Forca a 3 denti tondi
 Horquilla con 3 dientes redondos
 Heu- und Dunggabel mit 3 Zinken rund
 Fork with 3 round prong



Art.	Gr.	*175 cm	Pz./St.	€	EAN
2493	1770		4	18,25-	8 016604 024931
2293	800		12	13,10-	8 016604 022937

Forca a 4 denti tondi
 Horquilla con 4 dientes redondos
 Heu- und Dunggabel mit 4 Zinken rund
 Fork with 4 round prong



Art.	Gr.	cm	Pz./St.	€	EAN
2258	1900	125 cm	2	29,20-	8 016604 022586

Forca a 4 denti piatti
 Horquilla con 4 dientes planos
 Heu- und Dunggabel mit 4 Zinken platt
 Fork with 4 plane prong



- Manico in legno 1 m**
- Mango de madera 1 m**
- Holzstiel 1 m**
- Wooden handle 1 m**

Per/para/für/for Art. 2276, 2476



Art.	cm	Gr.	Pz./St.	€	EAN
2211	100 cm	694	12	6,00-	8 016604 022111

- Pala in alluminio**
- Pala de aluminio**
- Aluminiumschaufel**
- Aluminium shovel**



Art.	Gr.	*140 cm	Pz./St.	€	EAN
2477	1460		4	16,15-	8 016604 024777
2277	490		12	11,10-	8 016604 022777

- Pala in acciaio**
- Pala de acero**
- Stahlschaufel**
- Steel shovel**

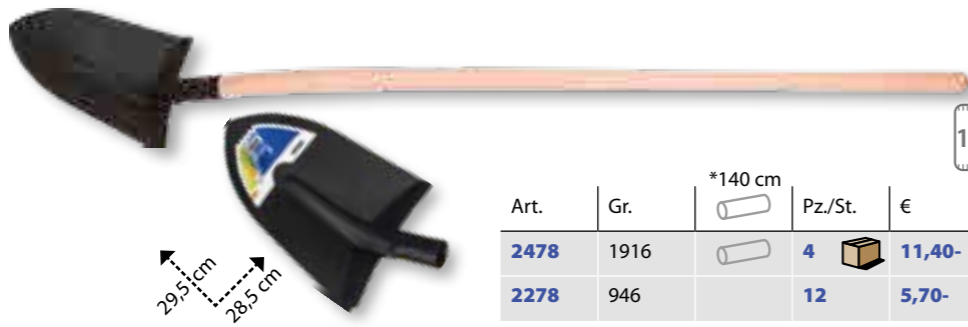

Art.	Gr.	*140 cm	Pz./St.	€	EAN
2478	1916		4	11,40-	8 016604 024788
2278	946		12	5,70-	8 016604 022784

- Espositore per pale**
Con manico in legno. (24 pz x Art. 2478)

- Expositor para palas**
Con mango de madera. (24 pzs x art. 2478)

- Display für Stahlschaufeln**
Mit Holzstiel. (24 St. x Art. 2478)

- Display for shovels**
With wooden handle. (24 pcs for item 2478)



Art.	Gr.	Pz./St.	€	EAN
2249	1916	24	10,75-	

- Vanga a cuore 1390 g**
- Pala en forma de corazón 1390 g**
- Herzförmiger Spaten 1390 g**
- Heart-shaped spade 1390 g**

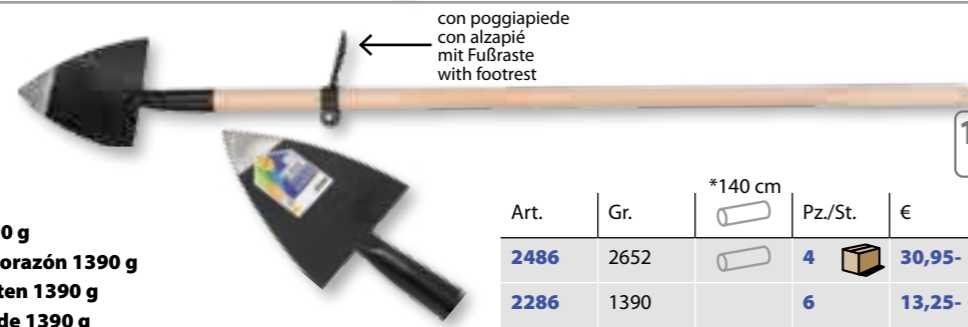

Art.	Gr.	*140 cm	Pz./St.	€	EAN
2486	2652		4	30,95-	8 016604 024863
2286	1390		6	13,25-	8 016604 022869

- Manico in legno 1,4 m**
- Mango de madera 1,4 m**
- Holzstiel 1,4 m**
- Wooden handle 1,4 m**

* 2212: Per/para/für/for Art. 2277, 2278, 2279, 2292, 2293, 2477, 2478, 2479, 2480, 2492, 2493

* 2225: Per/para/für/for Art. 2286, 2287, 2486, 2487, 2481



Art.	cm	Gr.	Pz./St.	€	EAN
2212*	140 cm	970	12	5,80-	8 016604 022128
2225*	140 cm	1012	12	6,45-	8 016604 022258

BESTSELLER

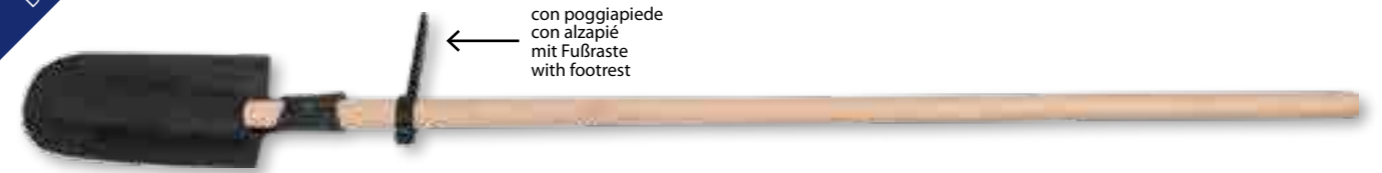

- Vanga ortolano 1300 g**
In acciaio forgiato e con manico in legno da 140 cm.

- Pala verdulero 1300 g**
De acero forjado y con mango de madera de 140 cm.

- Gärtnerspaten 1300 g**
Aus geschmiedetem Stahl und mit 140 cm Holzgriff.

- Gardener's spade 1300 g**
In forged steel with wooden-handle of 140 cm.



Art.	Gr.	*140 cm	Pz./St.	€	EAN
2487	2562		4	39,40-	8 016604 024870
2287	1300		6	21,05-	8 016604 022876

- Poggiapiede per vanga**
- Alzapié para pala**
- Fußraste für Spaten**
- Footrest for spade**



Art.	Gr.	*140 cm	Pz./St.	€	EAN
2481	250		12	10,75-	8 016604 024818

- Vanga larga**
Con manico in legno e pratica impugnatura.

- Pala ancha**
Con mango de madera y práctica empuñadura.

- Gärtnerspaten breit**
Mit Holzstiel und praktischem Griff.

- Wide spade**
With wooden handle and D-grip.



Art.	cm	Gr.	Pz./St.	€	EAN
2250	116		2	21,85-	8 016604 022500

NEWSLETTER - DIRETTAMENTE A + 35.000 CONTATTI

Appassionati e professionisti che vogliono rimanere aggiornati su tutte le novità:

nuovi prodotti, promozioni ed eventi!

Un'ottima occasione per coniugare prodotti e conoscenze.

NEWSLETTER: DIRECTLY TO + 35,000 CONTACTS

Enthusiasts and professionals who want to keep up to date with all the latest news:

new products, promotions and events!

An excellent opportunity to combine products and knowledge.



Pala in acciaio
Con manico in legno e pratica impugnatura.



124 cm

Pala de acero
Con mango de madera y práctica empuñadura.

Schaufel aus Stahl
Mit Holzstiel und praktischem Handgriff.

Steel shovel
With wooden handle and D-grip.

Art.	cm	Gr.	Pz./St.	€	EAN
2251	124		2	19,45-	8 016604 022517

Pala in acciaio
Con manico in legno e pratica impugnatura.



70 cm

Pala de acero
Con mango de madera y práctica empuñadura.

Schaufel aus Stahl
Mit Holzstiel und praktischem Handgriff.

Steel shovel
With wooden handle and D-grip.

Art.	cm	Gr.	Pz./St.	€	EAN
2252	70		2	14,50-	8 016604 022524

Pala in acciaio
Con manico in legno.



150 cm

Pala de acero
Con mango de madera.

Schaufel aus Stahl
Mit Holzstiel.

Steel shovel
With wooden handle.

Art.	cm	Gr.	Pz./St.	€	EAN
2253	150		4	21,75-	8 016604 022531

Vanga ortolano
Con manico in legno e pratica impugnatura.



124 cm

Pala verdulero
Con mango de madera y práctica empuñadura.

Gärtnerspaten
Mit Holzstiel und praktischem D-Griff.

Gardener's spade
With wooden handle and D-grip.

Art.	cm	Gr.	Pz./St.	€	EAN
2256	124		2	20,00-	8 016604 022562

41 cm

33,5 cm

Ø mm 39

175 cm

ALU

Art.	Gr.	*140 cm	Pz./St.	€	EAN
2479	1712		4	22,50-	8 016604 024795
2279	742		5	16,20-	8 016604 022791

Pala da neve e grano
 Pala de nieve y trigo
 Schnee- und Getreideschaufel
 Snow and grain shovel

170 cm

Art.	cm	*140 cm	Pz./St.	€	EAN
2480	170 cm	1356	4	34,70-	8 016604 024801

Pala da neve e grano
 Pala de nieve y trigo
 Schnee- und Getreideschaufel
 Snow and grain shovel



KIDS GARDEN



Pala KIDS GARDEN
In metallo.

Pala KIDS GARDEN
De metal.

Gartenschaufel KIDS GARDEN
Aus Metall.

Shovel KIDS GARDEN
Metal. **CE**



Scopa KIDS GARDEN
Escoba KIDS GARDEN
Gartenbesen KIDS GARDEN
Broom KIDS GARDEN

Art.	cm	col./Farbe	Pz./St.	€	EAN
2303	78		4	10,70-	8 016604 023033
2306	78		4	10,70-	8 016604 023064
2320	78		4	10,70-	8 016604 023200

Art.	cm	col./Farbe	Pz./St.	€	EAN
2301	78		4	8,80-	8 016604 023019
2304	78		4	8,80-	8 016604 023040
2318	78		4	8,80-	8 016604 023187



Secchiello KIDS GARDEN
In metallo.

Balde KIDS GARDEN
De metal.

Eimer KIDS GARDEN
Aus Metall.

Bucket KIDS GARDEN
Metal. **CE**

Art.	lt.	col./Farbe	Pz./St.	€	EAN
4913	1		6	6,90-	8 016604 049132
4915	1		6	6,90-	8 016604 049156
4926	1		6	6,90-	8 016604 049262



Set attrezzi e secchiello KIDS GARDEN
Set herramientas y balde KIDS GARDEN
Set Gartenwerkzeug und Eimer KIDS GARDEN
Garden tools and bucket set KIDS GARDEN **CE**

Art.	lt.	col./Farbe	Pz./St.	€	EAN
2326			6	17,10-	8 016604 023262
2322			6	17,10-	8 016604 023224
2329			6	17,10-	8 016604 023293



Rastrello KIDS GARDEN
In metallo.

Rastrillo KIDS GARDEN
De metal.

Rechen KIDS GARDEN
Aus Metall.

Rake KIDS GARDEN
Metal. **CE**



Rastrello KIDS GARDEN
Con 7 denti.

Rastrillo KIDS GARDEN
Con 7 dientes.

Rechen KIDS GARDEN
Mit 7 Zinken.

Rake KIDS GARDEN
With 7 teeth. **CE**

Art.	cm	col./Farbe	Pz./St.	€	EAN
2302	78		4	8,80-	8 016604 023026
2305	78		4	8,80-	8 016604 023057
2321	78		4	8,80-	8 016604 023217

Art.	cm	col./Farbe	Pz./St.	€	EAN
2323	65		4	9,20-	8 016604 023231
2324	65		4	9,20-	8 016604 023248
2325	65		4	9,20-	8 016604 023255



Secchiello KIDS GARDEN
In plastica.

Balde KIDS GARDEN
De plástico.

Eimer KIDS GARDEN
Aus Kunststoff.

Bucket KIDS GARDEN
Plastic. **CE**

Art.	lt.	col./Farbe	Pz./St.	€	EAN
4927	1		12	6,00-	8 016604 049279
4928	1		12	6,00-	8 016604 049286



Carriola KIDS GARDEN
Con vasca in metallo.

Carretilla KIDS GARDEN
Con bandeja de metal.

Schubkarren KIDS GARDEN
Mit Metallwanne.

Wheelbarrow KIDS GARDEN
With a metal tray. **CE**

Art.	cm	Pz./St.	€	EAN
2316	75 x 37 x h 40,5 cm	4	37,70-	8 016604 023163



Espositore KIDS GARDEN
Expositor KIDS GARDEN
Display KIDS GARDEN
Display KIDS GARDEN

per /para /für /for Art. 2301, 2302, 2303, 2304, 2305, 2306, 2318, 2320, 2321

Art.	cm	Gr.	Pz./St.	€	EAN
2308					8 016604 023088



Set attrezzi KIDS GARDEN
Set herramientas KIDS GARDEN
Set Gartenwerkzeug KIDS GARDEN
Garden tools set KIDS GARDEN **CE**

Art.	cm	col./Farbe	Pz./St.	€	EAN
2309			6	6,40-	8 016604 023095
2310			6	6,40-	8 016604 023101



Innaffiatoio KIDS GARDEN
In metallo.

Regadera KIDS GARDEN
De metal.

Gießkanne KIDS GARDEN
Aus Metall.

Watering can KIDS GARDEN
Metal. **CE**

Art.	lt.	col./Farbe	Pz./St.	€	EAN
4914	1		6	12,00-	8 016604 049149
4916	1		6	12,00-	8 016604 049163
4924	1		6	12,00-	8 016604 049248



Innaffiatoio KIDS GARDEN
Regadera KIDS GARDEN
Gießkanne KIDS GARDEN
Watering can KIDS GARDEN **CE**

Art.	lt.	col./Farbe	Pz./St.	€	EAN
4919	0,35		12	5,40-	8 016604 049194
4920	0,35		12	5,40-	8 016604 049200
4925	0,35		12	5,40-	8 016604 049255



Paletta KIDS GARDEN
Paletta in metallo con manico in legno.

Pala KIDS GARDEN
Pequeña pala de metal con mango de madera.

Kleine Schaufel KIDS GARDEN
Metallschaufel mit Holzgriff.

Small shovel KIDS GARDEN
Small metal shovel with a wooden handle.

Art.	cm	col./Farbe	Pz./St.	€	EAN
2313		■	12	3,80-	8 016604 023132



Set attrezzi KIDS GARDEN
In metallo.

Set herramientas KIDS GARDEN
De metal.

Set Gartenwerkzeug KIDS GARDEN
Aus Metall.

Garden tools set KIDS GARDEN
Metal.

Art.	cm	Gr.	Pz./St.	€	EAN
2307			6	8,20-	8 016604 023071



Vanghetta KIDS GARDEN
Vanghetta in metallo con manico in legno.

Pala KIDS GARDEN
Pequeña pala de metal con mango de madera.

Kleiner Spaten KIDS GARDEN
Metallspaten mit Holzgriff.

Small spade KIDS GARDEN
Small metal shovel with a wooden handle.

Art.	cm	col./Farbe	Pz./St.	€	EAN
2314		■	12	3,80-	8 016604 023149



Rastrellino KIDS GARDEN
Rastrellino in metallo con manico in legno.

Rastrillo KIDS GARDEN
Pequeño rastrillo de metal con mango de madera.

Kleinrechen KIDS GARDEN
Metallrechen mit Holzgriff.

Small rake KIDS GARDEN
Small metal rake with a wooden handle.

Art.	cm	col./Farbe	Pz./St.	€	EAN
2315		■	12	3,80-	8 016604 023156

Guanti da giardino KIDS GARDEN
Con polsino regolabile. In materiale di alta qualità.

Guantes de jardín KIDS GARDEN
Con velcro regulable. Con material de alta calidad.

Gartenhandschuhe KIDS GARDEN
Mit Klettverschluss. Erstklassige Qualität.

Garden gloves KIDS GARDEN
With velcro fastening. First-class material.

Art.	cm	col./Farbe	Pz./St.	€	EAN
22068		■	6	5,80-	8 016604 220685
22069		■	6	5,80-	8 016604 220692



Guanti da giardino KIDS GARDEN
Guantes de jardín KIDS GARDEN
Gartenhandschuhe KIDS GARDEN
Garden gloves KIDS GARDEN

Art.	cm	col./Farbe	Pz./St.	€	EAN
22056		■	12	2,75-	8 016604 220562



Guanti da giardino KIDS GARDEN
Guantes de jardín KIDS GARDEN
Gartenhandschuhe KIDS GARDEN
Garden gloves KIDS GARDEN

Art.	cm	col./Farbe	Pz./St.	€	EAN
22057		■	12	2,75-	8 016604 220579



Guanti da giardino KIDS GARDEN
Guantes de jardín KIDS GARDEN
Gartenhandschuhe KIDS GARDEN
Garden gloves KIDS GARDEN

Art.	cm	col./Farbe	Pz./St.	€	EAN
22058		■	12	2,75-	8 016604 220586



Lissi Mangiatoia da colorare KIDS GARDEN
Lissi Comedero para pintar KIDS GARDEN
Lissi Futterhaus zum anmalen KIDS GARDEN
Lissi paint a bird feeder KIDS GARDEN

* fino ad esaurimento
* hasta agotamiento
* solange der Vorrat reicht
* While supplies last

Art.	cm	Pz./St.	€	EAN
4415	22 x 16 x h 19 cm	4	45,40-	8 016604 044151



Cappello in paglia KIDS GARDEN
Sombrero de paja KIDS GARDEN
Strohhut KIDS GARDEN
Straw hat KIDS GARDEN

Art.	mis./Gr.	Pz./St.	€	EAN
1601	53	12	6,90-	8 016604 016011

* Con gancio per esposizione
 * Con gancho para exposición
 * Mit Haken für Verkaufsständer
 * With hook for display



Zoccoli da giardino KIDS GARDEN perforato verde
 Comodi e leggerissimi, in morbido materiale EVA antiscivolo e resistente all'abrasione. Chiusura a sandalo che evita che lo zoccolo si sfili.

Zuecos de jardín KIDS GARDEN perforado verde
 Cómodi y muy ligeros, de suave material EVA antideslizante y resistente a la abrasión. Cierre de sandalia que evita que el zueco se quite.

Gelochte Gartenschuhe KIDS GARDEN Grün
 Komfortabel und leicht, aus weichem, rutschfestem, abriebfestem EVA-Material. Sandalenverschluss, für einen besseren Halt.

Garden shoes KIDS GARDEN perforated green
 Comfortable and super-light, made from soft EVA rubber, non slip and abrasion-resistant. Back-closure that avoids losing the shoe.

Art.	mis./Gr.	col./Farbe	Pz./St.	€	EAN
3726	26-27	■	4	14,40-	8 016604 037269
3728	28-29	■	4	14,40-	8 016604 037283
3730	30-31	■	4	14,40-	8 016604 037306
3732	32-33	■	4	14,40-	8 016604 037320
3734	34-35	■	4	14,40-	8 016604 037344

* Con gancio per esposizione
 * Con gancho para exposición
 * Mit Haken für Verkaufsständer
 * With hook for display



Zoccoli da giardino KIDS GARDEN perforato arancione
 Comodi e leggerissimi, in morbido materiale EVA antiscivolo e resistente all'abrasione. Chiusura a sandalo che evita che lo zoccolo si sfili.

Zuecos de jardín KIDS GARDEN perforado naranja
 Cómodi y muy ligeros, de suave material EVA antideslizante y resistente a la abrasión. Cierre de sandalia que evita que el zueco se quite.

Gelochte Gartenschuhe KIDS GARDEN Orange
 Komfortabel und leicht, aus weichem, rutschfestem, abriebfestem EVA-Material. Sandalenverschluss, für einen besseren Halt.

Garden shoes KIDS GARDEN perforated orange
 Comfortable and super-light, made from soft EVA rubber, non slip and abrasion-resistant. Back-closure that avoids losing the shoe.

Art.	mis./Gr.	col./Farbe	Pz./St.	€	EAN
3826	26-27	■	4	14,40-	8 016604 038266
3828	28-29	■	4	14,40-	8 016604 038280
3830	30-31	■	4	14,40-	8 016604 038303
3832	32-33	■	4	14,40-	8 016604 038327
3834	34-35	■	4	14,40-	8 016604 038341

* Con gancio per esposizione
 * Con gancho para exposición
 * Mit Haken für Verkaufsständer
 * With hook for display



* fino ad esaurimento
 * hasta agotamiento
 * solange der Vorrat reicht
 * While supplies last



Stivali rana KIDS GARDEN
Botas rana KIDS GARDEN
Stiefel Frosch KIDS GARDEN
Rain boots frog KIDS GARDEN

Art.	mis./Gr.	col./Farbe	Pz./St.	€	EAN
1821	21	■	12	19,20-	8 016604 018213
1822	22	■	12	19,20-	8 016604 018220
1823	23	■	12	19,20-	8 016604 018237
1824	24	■	12	19,20-	8 016604 018244
1825	25	■	12	19,20-	8 016604 018251
1826	26	■	12	19,20-	8 016604 018268
1827	27	■	12	19,20-	8 016604 018275
1828	28	■	12	19,20-	8 016604 018282
1829	29	■	12	19,20-	8 016604 018299
1830	30	■	12	19,20-	8 016604 018305
1831	31	■	12	19,20-	8 016604 018312
1832	32	■	12	19,20-	8 016604 018329
1833	33	■	12	19,20-	8 016604 018336
1834	34	■	12	19,20-	8 016604 018343
2135	35	■	12	19,20-	8 016604 021350

* Con gancio per esposizione
 * Con gancho para exposición
 * Mit Haken für Verkaufsständer
 * With hook for display



* fino ad esaurimento
 * hasta agotamiento
 * solange der Vorrat reicht
 * While supplies last



Stivali pirata KIDS GARDEN
Botas pirata KIDS GARDEN
Pirat Stiefel KIDS GARDEN
Rain boots pirate KIDS GARDEN

Art.	mis./Gr.	col./Farbe	Pz./St.	€	EAN
1127	27	■	24	22,40-	8 016604 011276
1128	28	■	24	22,40-	8 016604 011283
1129	29	■	24	22,40-	8 016604 011290
1130	30	■	24	22,40-	8 016604 011306
1131	31	■	24	22,40-	8 016604 011313
1132	32	■	24	22,40-	8 016604 011320
1133	33	■	24	22,40-	8 016604 011337
1134	34	■	24	22,40-	8 016604 011344
1135	35	■	24	22,40-	8 016604 011351

* Con gancio per esposizione
 * Con gancho para exposición
 * Mit Haken für Verkaufsständer
 * With hook for display



* fino ad esaurimento
 * hasta agotamiento
 * solange der Vorrat reicht
 * While supplies last



Stivali farfalla KIDS GARDEN
Botas mariposa KIDS GARDEN
Stiefel Schmetterling KIDS GARDEN
Rain boots butterfly KIDS GARDEN

Art.	mis./Gr.	col./Farbe	Pz./St.	€	EAN
2821	21	■	12	19,20-	8 016604 028212
2822	22	■	12	19,20-	8 016604 028229
2823	23	■	12	19,20-	8 016604 028236
2824	24	■	12	19,20-	8 016604 028243
2825	25	■	12	19,20-	8 016604 028250
2826	26	■	12	19,20-	8 016604 028267
2827	27	■	12	19,20-	8 016604 028274
2828	28	■	12	19,20-	8 016604 028281
2829	29	■	12	19,20-	8 016604 028298
2830	30	■	12	19,20-	8 016604 028304
2831	31	■	12	19,20-	8 016604 028311
2832	32	■	12	19,20-	8 016604 028328
2833	33	■	12	19,20-	8 016604 028335
2834	34	■	12	19,20-	8 016604 028342
2835	35	■	12	19,20-	8 016604 028359

* Con gancio per esposizione
 * Con gancho para exposición
 * Mit Haken für Verkaufsständer
 * With hook for display



* fino ad esaurimento
 * hasta agotamiento
 * solange der Vorrat reicht
 * While supplies last



Stivali pirata KIDS GARDEN
Botas pirata KIDS GARDEN
Pirat Stiefel KIDS GARDEN
Rain boots pirate KIDS GARDEN

Art.	mis./Gr.	col./Farbe	Pz./St.	€	EAN
1227	27	■	24	22,40-	8 016604 012273
1228	28	■	24	22,40-	8 016604 012280
1229	29	■	24	22,40-	8 016604 012297
1230	30	■	24	22,40-	8 016604 012303
1231	31	■	24	22,40-	8 016604 012310
1232	32	■	24	22,40-	8 016604 012327
1233	33	■	24	22,40-	8 016604 012334
1234	34	■	24	22,40-	8 016604 012341
1235	35	■	24	22,40-	8 016604 012358

stocker

www.stockergarden.com

LEGATRICI E COLTELLI

ATADORAS Y NAVAJAS
BINDEGERÄTE UND MESSER
BINDERS AND KNIVES

Art. 753

180

Ascia da taglio 600 g
Testa da 500 grammi in acciaio al carbonio con rivestimento anti-attrito. Manico leggero in nylon e fibra di vetro con interno vuoto che riduce le vibrazioni. Custodia con passante per cintura.

Hacha de corte 600 g
Cabeza de 500 gramos de acero al carbono con revestimiento antifricción. Mango ligero de nylon y fibra de vidrio con interior vacío que reduce las vibraciones. Funda con lazo para cinturón.

Forstbeil 600 g
500 Gramm schwerer Karbon-Stahl Kopf mit Antihafbeschichtung. Der leichte Griff aus Nylon und Glasfaser mit leerem Innenraum reduziert Vibrationen. Hülle mit Gürtelschleife.

Chopping ax 600 g
High-carbon steel 500 grams cutting-head with anti-friction coating. Light fibreglass and nylon handle that is empty inside to reduce the vibrations. Cover with belt-loop.

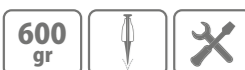

Art.	cm	Gr.	Pz./St.	€	EAN
752	25	600	4	24,00-	8 016604 007521



Ascia da taglio 700 g
Testa da 500 grammi in acciaio al carbonio con rivestimento anti-attrito. Manico leggero in nylon e fibra di vetro con interno vuoto che riduce le vibrazioni.

Hacha de corte 700 g
Cabeza de 500 gramos de acero al carbono con revestimiento antifricción. Mango ligero de nylon y fibra de vidrio con interior vacío que reduce las vibraciones.

Forstbeil 700 g
500 Gramm schwerer Karbon-Stahl Kopf mit Antihafbeschichtung. Der leichte Griff aus Nylon und Glasfaser mit leerem Innenraum reduziert Vibrationen.

Chopping ax 700 g
500 grams high-carbon steel cutting-head with anti-friction coating. Light fibreglass and nylon handle that is empty inside to reduce the vibrations.

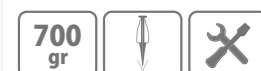

Art.	cm	Gr.	Pz./St.	€	EAN
753	35	700	4	30,10-	8 016604 007538



Ascia da taglio 900 g
Testa da 700 grammi in acciaio al carbonio con rivestimento anti-attrito. Manico leggero in nylon e fibra di vetro con interno vuoto che riduce le vibrazioni. Custodia con passante per cintura.

Hacha de corte 900 g
Cabeza de 700 gramos de acero al carbono con revestimiento antifricción. Mango ligero de nylon y fibra de vidrio con interior vacío que reduce las vibraciones. Funda con lazo para cinturón.

Forstbeil 900 g
700 Gramm schwerer Karbon-Stahl Kopf mit Antihafbeschichtung. Der leichte Griff aus Nylon und Glasfaser mit leerem Innenraum reduziert Vibrationen. Hülle mit Gürtelschleife.

Chopping ax 900 g
High-carbon steel 700 grams cutting-head with anti-friction coating. Light fibreglass and nylon handle that is empty inside to reduce the vibrations. Cover with belt-loop.

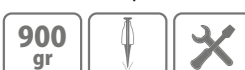

Art.	cm	Gr.	Pz./St.	€	EAN
760	45	900	4	34,50-	8 016604 007606



Ascia da spacco 1000 g
Testa da 800 grammi in acciaio al carbonio con rivestimento anti-attrito. Manico leggero in nylon e fibra di vetro con interno vuoto che riduce le vibrazioni. Custodia con passante per cintura.

Hacha de hendidura 1000 g
Cabeza de 800 gramos de acero al carbono con revestimiento antifricción. Mango ligero de nylon y fibra de vidrio con interior vacío que reduce las vibraciones. Funda con lazo para cinturón.

Spaltax 1000 g
800 Gramm schwerer Karbon-Stahl Kopf mit Antihafbeschichtung. Der leichte Griff aus Nylon und Glasfaser mit leerem Innenraum reduziert Vibrationen. Hülle mit Gürtelschleife.

Splitting ax 1000 g
High-carbon steel 800 grams cutting-head with anti-friction coating. Light fibreglass and nylon handle that is empty inside to reduce the vibrations. Cover with belt-loop.



Art.	cm	Gr.	Pz./St.	€	EAN
761	45	1000	4	35,40-	8 016604 007613



Ascia da spacco 1400 g
Testa in acciaio al carbonio da 1 kg con rivestimento anti-attrito. Manico leggero in nylon e fibra di vetro con interno vuoto che riduce le vibrazioni. Custodia con passante per cintura.

Hacha de hendidura 1400 g
Cabeza en acero al carbono de 1 kilo con revestimiento antifricción. Mango ligero de nylon y fibra de vidrio con interior vacío que reduce las vibraciones. Funda con lazo para cinturón.

Spaltax 1400 g
1 kg schwerer Karbon-Stahl Kopf mit Antihafbeschichtung. Der leichte Griff aus Nylon und Glasfaser mit leerem Innenraum reduziert Vibrationen. Hülle mit Gürtelschleife.

Splitting ax 1400 g
High-carbon steel 1 kg cutting-head with anti-friction coating. Light fibreglass and nylon handle that is empty inside to reduce the vibrations. Cover with belt-loop.



Art.	cm	Gr.	Pz./St.	€	EAN
754	60	1400	4	46,55-	8 016604 007545



Ascia da spacco 2100 g
Testa in acciaio al carbonio da 1,5 kg con rivestimento anti-attrito. Manico leggero in nylon e fibra di vetro con interno vuoto che riduce le vibrazioni. Robusta custodia con impugnatura.

Hacha de hendidura 2100 g
Cabeza de acero al carbono de 1,5 kg con revestimiento antifricción. Mango ligero de nylon y fibra de vidrio con interior vacío que reduce las vibraciones. Funda resistente con empuñadura.

Spaltax 2100 g
1,5 kg schwerer Karbon-Stahl Kopf mit Antihafbeschichtung. Der leichte Griff aus Nylon und Glasfaser mit leerem Innenraum reduziert Vibrationen. Mit robuster Hülle und praktischem Griff.

Splitting ax 2100 g
High-carbon steel 1,5 kg cutting-head with anti-friction coating. Light fibreglass and nylon handle that is empty inside to reduce the vibrations. Sturdy sheath with handle.



Art.	cm	Gr.	Pz./St.	€	EAN
762	70	2100	4	57,30-	8 016604 007620



BESTSELLER

Roncola 270 MC

Lama in acciaio al carbonio con rivestimento anti-atrito. Manico leggero in nylon e fibra di vetro con interno vuoto che riduce le vibrazioni. Punta arrotondata per una maggiore sicurezza. Custodia con passante per cintura.

Machete 270 MC

Hoja en acero al carbono con revestimiento antifricción. Mango ligero de nylon y fibra de vidrio con interior vacío que reduce las vibraciones. Punta redondeada para una mayor seguridad. Funda con lazo para cinturón.

Machete 270 MC

Klinge aus Karbon-stahl mit Antihafbeschichtung. Der leichte Griff aus Nylon und Glasfaser mit leerem Innenraum reduziert Vibrationen. Abgerundete Spitze für zusätzliche Sicherheit. Hülle mit Gürtelschleufe.

Billhook 270 MC

High-carbon steel blade with anti-friction coating. Light fibreglass and nylon handle that is empty inside to reduce the vibrations. Rounded tip for more safety. Cover with belt-loop.



Art.	cm	Gr.	Pz./St.	€	EAN
755	61	450	4	27,75-	8 016604 007552



Roncola 270 ML

Lama in acciaio al carbonio con rivestimento anti-atrito. Manico leggero in nylon e fibra di vetro con interno vuoto che riduce le vibrazioni. Punta arrotondata per una maggiore sicurezza. Custodia con passante per cintura.

Machete 270 ML

Hoja en acero al carbono con revestimiento antifricción. Mango ligero de nylon y fibra de vidrio con interior vacío que reduce las vibraciones. Punta redondeada para una mayor seguridad. Funda con lazo para cinturón.

Machete 270 ML

Klinge aus Karbon-stahl mit Antihafbeschichtung. Der leichte Griff aus Nylon und Glasfaser mit leerem Innenraum reduziert Vibrationen. Abgerundete Spitze für zusätzliche Sicherheit. Hülle mit Gürtelschleufe.

Billhook 270 ML

High-carbon steel blade with anti-friction coating. Light fibreglass and nylon handle that is empty inside to reduce the vibrations. Rounded tip for more safety. Cover with belt-loop.



Art.	cm	Gr.	Pz./St.	€	EAN
756	76	600	4	33,20-	8 016604 007569



Roncola 300 MC

Lama in acciaio al carbonio con rivestimento anti-atrito. Manico leggero in nylon e fibra di vetro con interno vuoto che riduce le vibrazioni. Punta arrotondata per una maggiore sicurezza. Custodia con passante per cintura.

Machete 300 MC

Hoja en acero al carbono con revestimiento antifricción. Mango ligero de nylon y fibra de vidrio con interior vacío que reduce las vibraciones. Punta redondeada para una mayor seguridad. Funda con lazo para cinturón.

Machete 300 MC

Klinge aus Karbon-stahl mit Antihafbeschichtung. Der leichte Griff aus Nylon und Glasfaser mit leerem Innenraum reduziert Vibrationen. Abgerundete Spitze für zusätzliche Sicherheit. Hülle mit Gürtelschleufe.

Billhook 300 MC

High-carbon steel blade with anti-friction coating. Light fibreglass and nylon handle that is empty inside to reduce the vibrations. Rounded tip for more safety. Cover with belt-loop.



Art.	cm	Gr.	Pz./St.	€	EAN
757	65	470	4	28,75-	8 016604 007576



Roncola 300 ML

Lama in acciaio al carbonio con rivestimento anti-atrito. Manico leggero in nylon e fibra di vetro con interno vuoto che riduce le vibrazioni. Punta arrotondata per una maggiore sicurezza. Custodia con passante per cintura.

Machete 300 ML

Hoja en acero al carbono con revestimiento antifricción. Mango ligero de nylon y fibra de vidrio con interior vacío que reduce las vibraciones. Punta redondeada para una mayor seguridad. Funda con lazo para cinturón.

Machete 300 ML

Klinge aus Karbon-stahl mit Antihafbeschichtung. Der leichte Griff aus Nylon und Glasfaser mit leerem Innenraum reduziert Vibrationen. Abgerundete Spitze für zusätzliche Sicherheit. Hülle mit Gürtelschleufe.

Billhook 300 ML

High-carbon steel blade with anti-friction coating. Light fibreglass and nylon handle that is empty inside to reduce the vibrations. Rounded tip for more safety. Cover with belt-loop.



Art.	cm	Gr.	Pz./St.	€	EAN
758	79	620	4	34,20-	8 016604 007583



☑ Affilame per asce e roncole
Impugnare l'affilame con la mano sul lato nero in morbida gomma, mantenendo il lato arrotondato verso il basso. Inserire la lama nell'apposito spazio e farla scorrere dall'alto verso il basso con una moderata energia.

☑ Afilador para achas y machetes
Sostener el afilador con la mano en el lado negro de suave goma, manteniendo el lado redondeado hacia abajo. Insertar la hoja en el espacio provisto y hacerla deslizar de arriba abajo con una energía moderada.

☑ Messerschärfer für Äxte und Macheten
Greifen Sie den Griff auf der schwarzen Gummiseite, wobei die abgerundete Seite nach unten zeigt. Setzen Sie die Klinge in den dafür vorgesehenen Schlitz ein und lassen Sie sie mit gemäßigter Energie von oben nach unten gleiten.

☑ Sharpening tool for axes and billhooks
Grab the handle on the black rubber side, with the rounded side facing downwards. Insert the blade in the dedicated slot and make it slide from top to bottom with moderated energy.



Art.	cm	Gr.	Pz./St.	€	EAN
9081	13,5	78	12	7,70-	8 016604 090813

* fino ad esaurimento
* hasta agotamiento
* solange der Vorrat reicht
* While supplies last

☑ Espositore per asce e roncole
In legno. Con ganci removibili in acciaio.

☑ Expositor para hachas y machetes
De madera. Con ganchos extraíbles de acero.

☑ Verkaufsständer für Äxte und Macheten
Hergestellt aus Holz. Mit abnehmbaren Stahlhaken.

☑ Display for axes and billhooks
Made from wood. With removable steel hooks.



Art.	cm	Pz./St.	€	EAN
46	110 x 38 x h 150			8 016604 000461

* fino ad esaurimento
* hasta agotamiento
* solange der Vorrat reicht
* While supplies last

Per/para/für/for Art. 752, 753, 754, 760, 761, 762, 755, 756, 757, 758.



☑ Legatrice Stocktap
Per nastri di diversi spessori.

☑ Atadora Stocktap
Para cintas de diversos espesores.

☑ Bindezange Stocktap
Für verschiedene Bandstärken.

☑ Stocktap binding machine
Strong band for different strengths of tape.

☒ vedi pag. 300
ver página 300
siehe Seite 300
see on page 300



Art.	cm	Gr.	Pz./St.	€	EAN
2055			5	47,35-	8 016604 020551

☑ Nastro
10 rotoli = 1 pz./St.

☑ Cinta
10 rollos = 1 pz./St.

☑ Band
10 Rollen = 1 pz./St.

☑ Tape
10 rolls = 1 pz./St.



Art.	m	col./Farbe	Pz./St.	€	EAN
2064/R	16 m	■	30	6,90-	8 016604 201202
2064/V	16 m	■	30	6,90-	8 016604 201202

☑ Nastro
10 rotoli = 1 pz./St.

☑ Cinta
10 rollos = 1 pz./St.

☑ Band
10 Rollen = 1 pz./St.

☑ Tape
10 rolls = 1 pz./St.



Art.	m	col./Farbe	Pz./St.	€	EAN
2065/T	20 m	/ (transp.)	30	6,85-	8 016604 020650
2065/B	26 m	■	30	6,90-	8 016604 200755
2065/V	26 m	■	30	6,90-	8 016604 200755

☑ Nastro
10 rotoli = 1 pz./St.

☑ Cinta
10 rollos = 1 pz./St.

☑ Band
10 Rollen = 1 pz./St.

☑ Tape
10 rolls = 1 pz./St.



Art.	m	col./Farbe	Pz./St.	€	EAN
2068/BO	40 m	□	30	7,25-	8 016604 020681
2068/V	40 m	■	30	7,25-	8 016604 020681

☑ Punta per legatrice
10 x 4800 punte (confezione) = 1 pz.

☑ Puntas para atadora
10 x 4800 grapas (confección) = 1 pz.

☑ Klammern für Bindezange
10 x 4800 Klammern (Verpackung) = 1 St.

☑ Staples for binding machine
10 x 4800 staples = 1 box.



6x4 mm

Art.	cm	Gr.	Pz./St.	€	EAN
2066			10	28,95-	8 016604 020667

- Lame per legatrice**
Hojas para atadora
Ersatzblatt für Bindezange
Blades for binding machine



3 x

Art.	cm	Gr.	Pz./St.	€	EAN
2067			12	6,40-	8 016604020674

- Legatrice Stockfix 19**
Ideale per la legatura di vigneti, frutteti e vivai.

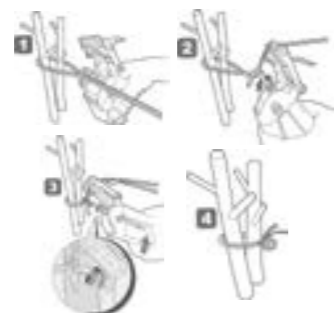

- Atadora Stockfix 19**
Ideal para la atadura de árboles frutales.

- Bindezange Stockfix 19**
Ideal für Bindearbeiten im Obst- und Weinbau.

- Stockfix binding machine 19**
Ideal for binding fruit-trees.



Art.	cm	Gr.	Pz./St.	€	EAN
2157	19 cm	280	5	27,00-	8 016604021572

- Legatrice manuale**
Per filo di ferro incartato o plastificato.

- Atadora manual**
Para hilo de hierro en papel o plastificado.

- Bindezange**
Ideal zum Arbeiten mit Bindendraht oder Kunststoff-Bindegarn.

- Manual binding machine**
Can be used with biodegradable wire or plastic covered wire.



Art.	cm	Gr.	Pz./St.	€	EAN
2057			5	19,85-	8 016604020575

- Pinza Legafix**
Legafix è una pinza ideale per la legatura nel frutteto.

- Pinza Legafix**
Legafix es una pinza ideal para entutorar en el huerto.

- Legafix Bindezange**
Legafix ermöglicht einfaches und schnelles fixieren des neu gepflanzten Baumes durch Baumfix.

- Legafix pliers**
Ideal for binding in your orchard.



Art.	cm	Gr.	Pz./St.	€	EAN
2059	18	190	12	17,00-	8 016604020599

- Coltello ad anello**
In plastica.

- Cuchillo de anillo**
De plástico.

- Ring-Schneidemesser**
Aus Kunststoff.

- Ring knife**
Plastic.



Art.	Ø	Gr.	Pz./St.	€	EAN
2049	20-24 mm		24	2,60-	8 016604020490

- Coltello ad anello**
In alluminio.

- Cuchillo de anillo**
En aluminio.

- Ring-Schneidemesser**
In Aluminium.

- Ring knife**
Aluminium.



Art.	Ø	Gr.	Pz./St.	€	EAN
2052	20 mm		24	3,90-	8 016604020520
2054	22 mm		24	3,90-	8 016604020544
2056	24 mm		24	3,90-	8 016604020568

- Set coltello ad anello**
In alluminio. 5 pezzi in blister.

- Set cuchillo de anillo**
En aluminio. 5 piezas por blister.

- Set Ring-Schneidemesser**
In Aluminium. 5 Stück im Blister.

- Ring knife set**
5 pieces per pack.



Art.	Ø	Gr.	Pz./St.	€	EAN
20520	20 mm		12	13,50-	8 016604205200
20540	22 mm		12	13,50-	8 016604205408
20560	24 mm		12	13,50-	8 016604205606

- Coltello da caccia**
Con lama inox e manico in legno.

- Cuchillo de caza**
Con hoja inox y mango de madera.

- Jagdmesser**
Mit Klinge aus Inox-Stahl und Holzgriff.

- Hunting knife**
With stainless steel blade and wooden handle.



Art.	mm	Gr.	Pz./St.	€	EAN
743	70	50	12	26,20-	8 016604007439
744	85	64	12	27,45-	8 016604007446
745	100	92	12	30,55-	8 016604007453

- Coltello universale L con fodero**
Dotato di affilatore integrato e pratica custodia con aggancio per la cintura o i pantaloni.

- Cuchillo universal L con funda**
Equipado con afilador integrado y práctico estuche con gancho para el cinturón o los pantalones.

- Universalmesser L mit Hülle**
Ausgestattet mit integriertem Messerschleifer und praktischer Hülle, die am Gürtel oder der Hose befestigt werden kann.

- Universal knife L with sheath**
Equipped with an integrated sharpener and a practical sheath that can be attached to a belt or the pants.



Art.	mm	Gr.	Pz./St.	€	EAN
751	85	131	12	14,40-	8 016604007514



- Coltello universale XL con fodero**
Dotato di affilatore integrato e pratica custodia con aggancio per la cintura o i pantaloni.

- Cuchillo universal XL con funda**
Equipado con afilador integrado y práctico estuche con gancho para el cinturón o los pantalones.

- Universalmesser XL mit Hülle**
Ausgestattet mit integriertem Messerschleifer und praktischer Hülle, die am Gürtel oder der Hose befestigt werden kann.

- Universal knife XL with sheath**
Equipped with an integrated sharpener and a practical sheath that can be attached to a belt or the pants.



Art.	mm	Gr.	Pz./St.	€	EAN
746	110	143	12	15,20-	8 016604007460

- Coltello da innesto 54**
Cuchillo de injerto 54
Okuliermesser 54
Grafting knife 54



Art.	mm	Gr.	Pz./St.	€	EAN
747	54	48	12	17,70-	8 016604007477

Coltello da innesto 44
Dotato di solleva corteccia in ottone.

Cuchillo de injerto 44
Con levanta corteza en latón.

Okuliermesser 44
Mit Messingklinge zum Lösen der Rinde.

Grafting knife 44
With brass bark lifter.



Art.	mm	Gr.	Pz./St.	€	EAN
748	44	36	12	28,70-	8 016604 007484

Coltello innesto roncola professionale
Cuchillo injerto machete profesional
Professionelle Baumschulhippe
Professional grafting billhook knife



Art.	mm	Gr.	Pz./St.	€	EAN
749	64	58	12	21,00-	8 016604 007491
750	69	78	12	23,70-	8 016604 007507

Coltello innesto roncola professionale 70
Cuchillo injerto machete profesional 70
Professionelle Baumschulhippe 70
Professional grafting billhook knife 70



Art.	mm	Gr.	Pz./St.	€	EAN
759	70	66	12	24,70-	8 016604 007590

Coltello da innesto roncola 55
Cuchillo de injerto roncola 55
Baumschulhippe 55
Grafting billhook knife 55



Art.	mm	Gr.	Pz./St.	€	EAN
740	55	66	12	26,10-	8 016604 007408

Coltello da innesto 55
Con lama in acciaio temperato e penna solleva corteccia.

Cuchillo de injerto 55
Con hoja en acero templado y cuña.

Okuliermesser 55
Mit Edelstahlklinge und einklappbarem Löser.

Grafting knife 55
With stainless steel blade and bark lifter.



Art.	mm	Gr.	Pz./St.	€	EAN
785	55	50	12	18,50-	8 016604 007859

Coltello da innesto
Cuchillo de injerto
Okuliermesser
Grafting knife



Art.	mm	Gr.	Pz./St.	€	EAN
741	50	48	12	24,75-	8 016604 007415
742	55	70	12	24,60-	8 016604 007422

Coltello da innesto
Con lama in acciaio temperato.

Cuchillo de injerto
Con hoja en acero templado.

Okuliermesser
Mit Edelstahlklinge.

Grafting knife
Stainless steel blade.



Art.	mm	Gr.	Pz./St.	€	EAN
779	50	40	12	16,70-	8 016604 007798
783	55	50	12	17,50-	8 016604 007835

Innestatrice Top
Lame per innesto a V. Lame in acciaio di altissima qualità. Ø 10 mm.

Máquina de injerto Top
Ejecuta un corte largo en V. Las hojas están realizadas con materiales de la más alta calidad. Ø 10 mm.

Veredelungszange Top
Ermöglicht V-Schnitt. Klingen aus hochwertigem Stahl. Ø 10 mm.

Top grafting machine
Executes the long V cut. High quality steel blades. Ø 10 mm.



Art.	cm	Gr.	Pz./St.	€	EAN
2170	29 cm	650	6	49,50-	8 016604 021701

Buddy Tape non perforato
Larghezza 25 mm. Rotolo da 60 m

Buddy Tape no perforado
Ancho 25 mm. Rollos de 60 m

Buddy Tape nicht perforiert
Breite 25 mm. Rollen zu 60 m

Non-perforated buddy-tape
Width 25 mm. Rolls 60 m



Art.	mm	m	Pz./St.	€	EAN
2075	25 mm	60 m	6	46,65-	8 016604 020759

Buddy Tape non perforato
Larghezza 25 mm. Rotolo da 5 m

Buddy Tape no perforado
Ancho 25 mm. Rollos de 5 m

Buddy Tape nicht perforiert
Breite 25 mm. Rollen zu 5 m

Non-perforated buddy-tape
Width 25 mm. Rolls 5 m



Art.	mm	m	Pz./St.	€	EAN
2081	25 mm	5 m	10	12,00-	8 016604 020810

Buddy Tape perforato
Ideale per innesto a fasciature. Aumenta la sua lunghezza di 8 volte. Autoadesivo.

Buddy Tape perforado
Ideal para injertos de vendaje. Aumenta su longitud de 8 veces, autoadhesivo y perforado.

Buddy Tape perforiert
Ideal für Veredelung und Tischveredelung. Elastisch und selbstklebend, schließt die Veredelungsstelle luftdicht ab (verlängert sich um ein Achtfaches).

Buddy Tape perforato
Buddy Tape is an innovative tape for grafting devised with a unique formulation to allow easy and rapid application. Self-adhesive and can stretch up to 8 times its original length.



Art.	mm	m	Perf.	Pz./St.	€	EAN
2071	25 mm	60 m	40 mm	6	49,85-	8 016604 020711
2077	30 mm	60 m	70 mm	5	50,30-	8 016604 020773
2088*	30 mm	60 m	40 mm	5	53,60-	8 016604 020889

* fino ad esaurimento
* hasta agotamiento
* solange der Vorrat reicht
* While supplies last





stocker

www.stockergarden.com

LEGACCI

ATADURAS
BINDEMATERIAL
BINDING MATERIAL

Art. 2063

195



Padrafix spago animato 500 m
Biodegradabile

Padrafix cuerda animada 500 m
Biodegradable

Padrafix Bindedraht 500 m
Biologisch abbaubar

Padrafix animated twine 500 m
Biodegradable



Art.	m x mm	Pz./St.	€	EAN
2048	500 m x 1 mm	20	14,80-	8 016604 197734

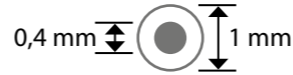

Padrafix spago animato 200 m
Biodegradabile



Padrafix cuerda animada 200 m
Biodegradable

Padrafix Bindedraht 200 m
Biologisch abbaubar

Padrafix animated twine 200 m
Biodegradable



Art.	m x mm	Pz./St.	€	EAN
2046	200 m x 0,8 mm	100	11,20-	8 016604 204692

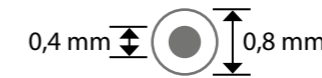

Padrafix spago animato
Biodegradabile



Padrafix cuerda animada
Biodegradable

Padrafix Bindedraht
Biologisch abbaubar

Padrafix animated twine
Biodegradable



Art.	Gr.	mm	Pz./St.	€	EAN
2062	1000	1,5 mm	12	21,35-	8 016604 206290

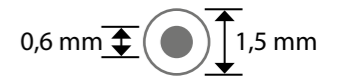

Padrafix spago animato 250 m
Biodegradabile



Padrafix cuerda animada 250 m
Biodegradable

Padrafix Bindedraht 250 m
Biologisch abbaubar

Padrafix animated twine 250 m
Biodegradable



Legafix spago animato
Biodegradabile



Legafix cuerda animada
Biodegradable

Legafix Bindedraht
Biologisch abbaubar

Legafix animated twine
Biodegradable



Art.	m x mm	Pz./St.	€	EAN
2158	250 m x 1 mm	30	5,50-	8 016604 021589
2148	500 m x 1 mm	20	10,05-	8 016604 021480

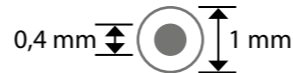

Padrafix spago animato
Biodegradabile



Padrafix cuerda animada
Biodegradable

Padrafix Bindedraht
Biologisch abbaubar

Padrafix animated twine
Biodegradable



Art.	cm x mm	Ø mm	gr/g	Pz./St.	€	EAN
2050	16 x 1,5	0,5	500	20	12,70-	8 016604 205064
2076	15 x 1,5	0,4	300	30	7,25-	8 016604 207662
2078	20 x 1,5	0,4	360	30	7,35-	8 016604 207808
2080	25 x 1,5	0,4	360	30	7,35-	8 016604 208034



Legafix spago biodegradabile
Filo in acciaio.



Legafix cuerda biodegradabile
Hilo en acero.

Legafix Bindedraht biologisch abbaubar
Stahldraht.

Legafix biodegradable twine
Steel wire.



Art.	cm	pz.conf./St. Verp.	Pz./St.	€	EAN
20110	10 cm	1.000	100	2,30-	8 016604 201103

* fino ad esaurimento
* hasta agotamiento
* solange der Vorrat reicht
* While supplies last

Stofix piattina animata
Biodegradabile. Bobina di filo animato incartato.



Stofix alambre animado
Biodegradable. Bobina de alambre forrado.

Stofix Bindedraht flach
Biologisch abbaubar. Bindedraht, flach.

Stofix animated flat binding wire
Biodegradable. Binding twine.



Stofix piattina animata
Bobina di piattina in plastica animata.



Stofix alambre animado
Bobina de alambre forrado de plástico.

Stofix Bindedraht flach
Kunststoff-Bindedraht flach.

Stofix animated flat binding wire
Plastic coated binding wire.



Art.	m x mm	Pz./St.	€	EAN
21250	250 m x 2,6 mm	30	5,90-	8 016604 212505
21500	500 m x 2,6 mm	20	10,10-	8 016604 215001

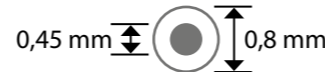

Stofix piattina animata
Biodegradabile



Stofix alambre animado
Biodegradable

Stofix Bindedraht flach
Biologisch abbaubar

Stofix animated flat binding wire
Biodegradable



Art.	cm	pz.conf./St. Verp.	Pz./St.	€	EAN
20210	10 cm	1.000	100	1,80-	8 016604 202100
20212	12 cm	1.000	90	2,10-	8 016604 202124
20215	15 cm	1.000	70	2,50-	8 016604 202155
20220	20 cm	1.000	50	3,25-	8 016604 202209
20225	25 cm	1.000	40	4,10-	8 016604 202254
20230	30 cm	1.000	30	4,60-	8 016604 202308
20235	35 cm	1.000	30	5,20-	8 016604 202353

Stofix piattina animata
Mazzetto di filo animato rivestito in plastica.



Stofix alambre animado
Manojo de alambre forrado plastificado.

Stofix Bindedraht flach
Bindedraht flach aus Kunststoff.

Stofix animated flat binding wire
Plastic Twist Tie.



Art.	cm	pz.conf./St. Verp.	Pz./St.	€	EAN
21212	12 cm	1.000	50	2,40-	8 016604 212123
21215	15 cm	1.000	40	2,95-	8 016604 212154
21220	20 cm	1.000	30	3,75-	8 016604 212208
21225	25 cm	1.000	20	5,15-	8 016604 212253
21230	30 cm	1.000	20	6,15-	8 016604 212307

Stofix piattina animata
Filo plastificato.

Stofix alambre animado
Hilo plastificado.

Stofix Bindedraht flach
Bindedraht plastifiziert.

Stofix animated flat binding wire
Plastic (PVC) twist tie.

30 m 50 m



Stofix piattina animata 30 m
Piattina biodegradabile.

Stofix alambre animado 30 m
Cinta plana biodegradable.

Stofix Bindedraht flach 30 m
Bindedraht flach biologisch.

Stofix animated flat binding wire 30 m
Binding twine biodegradable.

30 m eco

Art.	m	Gr.	Pz./St.	€	EAN
2073	30 m		20	2,20-	8 016604 020735
2060	50 m		20	4,20-	8 016604 020605
20130	30 m		20	2,40-	8 016604 201301



Filo zincato antiruggine
Hilo galvanizado inoxidable
Gartendraht verzinkt Rostschutz
Zinc-plated anti-rust wire

20 m



Art.	m	Ø mm	Pz./St.	€	EAN
20122	20 m	1 mm	12	2,30-	8 016604 201226
20125	20 m	1,4 mm	12	3,00-	8 016604 201257

Filo zincato antiruggine
Hilo galvanizado inoxidable
Gartendraht verzinkt Rostschutz
Zinc-plated anti-rust wire

40 m

Art.	m	Ø mm	Pz./St.	€	EAN
20127	40 m	0,6 mm	40	3,70-	8 016604 201271



Filo zincato plastificato
Hilo galvanizado plastificado
Gartendraht verzinkt plastifiziert
Zinc-plated plastified wire

20 m



Art.	m	Ø mm	Pz./St.	€	EAN
20123	20 m	1,2 mm	12	2,60-	8 016604 201233
20124	20 m	2 mm	12	3,40-	8 016604 201240

Filo zincato plastificato
Hilo galvanizado plastificado
Gartendraht verzinkt plastifiziert
Zinc-plated plastified wire

40 m

Art.	m	Ø mm	Pz./St.	€	EAN
20126	40 m	0,6 mm	40	3,70-	8 016604 201264



Tubetto PVC morbido
Macarrón PVC suave
Kunststoff-Hohlschnur
Soft PVC tubing

Art.	Ø mm	Gr.	Pz./St.	€	EAN
2051	2 mm	500	24	5,70-	8 016604 020513
20510	4 mm	1000	12	10,80-	8 016604 205101
20512	5 mm	1000	12	10,90-	8 016604 205125

Tubetto biodegradabile
Antigelo. Maggiore elasticità rispetto ai tubi convenzionali.

Macarrón biodegradabile
Anticongelante. Mayor elasticidad que los macarrones convencionales.

Biologisch abbaubare Hohlschnur
Frostsicher. Höhere Elastizität im Vergleich zu konventionellen Hohlschnuren.

Biodegradable tubing
Antifreeze. Higher elasticity compared to conventional tubings.

Art.	Ø mm	m	Pz./St.	€	EAN
2063	2 mm	100 m	24	11,90-	8 016604 020636
2089	3 mm	100 m	18	15,90-	8 016604 020896
2093	5 mm	100 m	12	21,80-	8 016604 020933



Stofix piattina animata
Laccetto biodegradabile.
Confezioni da 100 pz.

Stofix alambre animado
Cinta biodegradable.
Confección de 100 pz.

Stofix Bindedraht flach
Bindedraht biologisch.
Verpackung zu 100 St.

Stofix animated flat binding wire
Biodegradable binding twine.
Package of 100 pcs.

15 cm 20 cm 100 x eco



Art.	cm	Gr.	Pz./St.	€	EAN
20115	15 cm		20	1,20-	8 016604 201158
20121	20 cm		20	1,50-	8 016604 201219

Rafia naturale
Mazzetto.

Rafia natural
Manojo.

Naturbast
Bündel.

Natural raffia
Bundle.

eco



Art.	Gr.	Pz./St.	€	EAN
2074	50	48	2,00-	8 016604 586842
2079	150	24	4,70-	8 016604 020797



- ☑ **Rafia sintentica 50 m**
- ☑ **Rafia sintética 50 m**
- ☑ **Kunstbast 50 m**
- ☑ **Synthetic raffia 50 m**



50 m

Art.	m	Gr.	Pz./St.	€	EAN
2069	50 m		24	3,00-	8 016604 020698

- ☑ **Rafia sintentica 400 m**
- ☑ **Rafia sintética 400 m**
- ☑ **Kunstbast 400 m**
- ☑ **Synthetic raffia 400 m**



400 m

Art.	m	Gr.	Pz./St.	€	EAN
2070	400 m		20	4,40-	8 016604 020704

- ☑ **Jutec Filo in juta biodegradabile 50 m**
- Filo di iuta biodegradabile al 100%.

- ☑ **Jutec Hilo de yute biodegradable 50 m**
- Hilo de yute biodegradable al 100%.

- ☑ **Jutec Jutegarn biologisch abbaubar 50 m**
- Jutegarn zu 100% biologisch abbaubar.

- ☑ **Jutec biodegradable jute twine 50 m**
- Jute garden twine 100% biodegradable.



50 m



Art.	m	col./Farbe	Pz./St.	€	EAN
4698	50 m		24	3,50-	8 016604 046988
4697	50 m		24	3,50-	8 016604 046971

- ☑ **Jutec Filo in juta biodegradabile**
- Filo in fibra di iuta biodegradabile al 100%.

- ☑ **Jutec Hilo de yute biodegradable**
- Hilo en fibra de yute biodegradable 100%.

- ☑ **Jutec Jutegarn biologisch abbaubar**
- Jutespagat 100% biologisch abbaubar.

- ☑ **Jutec biodegradable jute twine**
- Jute Rope. The jute is 100% biodegradable.



100 m

250 m



Art.	m	Gr.	Pz./St.	€	EAN
4695	100 m		12	2,20-	8 016604 046957
4696	250 m		12	4,40-	8 016604 046964

- ☑ **Protac Fascia per tronco**
- 100% iuta. Bobina.

- ☑ **Protac - Faja para tronco**
- 100% yute. Bobina.

- ☑ **Protac Jutestreifen**
- 100% Jute. Spule.

- ☑ **Protac band for tree trunk**
- Made of 100% jute material. Roll.



25 m



Art.	m x m	Gr./m ²	Pz./St.	€	EAN
4640	0,15 x 25 m	210	12	18,60-	8 016604 046407

- ☑ **Corda in cocco a 7 fili**
- 100% fibra di cocco a 7 fili, corda intrecciata piatta. 1,8 KN.

- ☑ **Cuerda de coco con 7 hilos**
- 100% fibra de coco con 7 hilos, cuerda trenzada plana. 1,8 KN.

- ☑ **Kokoskordel mit 7 Fäden**
- Kokoskordel geflochten aus 100% Kokos. 1,8 KN.

- ☑ **Coconut twine 7 threads**
- 100% coconut fiber with 7 strands. Flat braided rope. 1.8 KN.



100 m



Art.	mm x m	Pz./St.	€	EAN
4620	ca. 20 mm x 100 m	6	96,30-	8 016604 046209

- ☑ **Corda di cocco**
- Corda al 100% di cocco. Alto valore ecologico, biodegradabile. Protegge le piante da ferite.

- ☑ **Cuerda de coco**
- Cuerda 100% de coco. Ecológica, biodegradable. Evita heridas en las plantas.

- ☑ **Kokosgarn**
- Seil aus 100% Kokos. Ökologisch wertvoll, biologisch abbaubar. Verhindert Verletzungen der Pflanzen.

- ☑ **Coconut twine**
- 100% biodegradable coconut fiber. Prevents injury to plants.

Art.	m	Gr.	Pz./St.	€	EAN
4670	100 m		6	23,00-	8 016604 046704
4675	15 m		12	2,40-	8 016604 046759



- ☑ **Cintura porta attrezzi piccola**
- Lunghezza cintura da 87 a 124 cm.

- ☑ **Correa cuelga herramientas pequeña**
- Longitud correa de 87 a 124 cm.

- ☑ **Werkzeuggürtel klein**
- Gürtellänge von 87 bis 124 cm.

- ☑ **Garden tools belt small**
- Belt lenght from 87 to 124 cm.



Art.	cm	Gr.	Pz./St.	€	EAN
492	18 x 24,5	130	12	12,10-	8 016604 004926

- ☑ **Cintura porta attrezzi**
- Lunghezza cintura da 87 a 124 cm.

- ☑ **Correa cuelga herramientas**
- Longitud correa de 87 a 124 cm.

- ☑ **Werkzeuggürtel**
- Gürtellänge von 87 bis 124 cm.

- ☑ **Garden tools belt**
- Belt lenght from 87 to 124 cm.



Art.	cm	Gr.	Pz./St.	€	EAN
491	27 x 26,5	156	12	13,70-	8 016604 004919

- ☑ **Fodero in cuoio per legacci**
- ☑ **Funda de cuero para ataduras**
- ☑ **Ledertasche für Bindematerialien**
- ☑ **Leather pouch bag**

Art.	cm	Gr.	Pz./St.	€	EAN
421	21 x 13,5 x h 22	273	4	25,40-	8 016604 004216



- ☑ **Fodero in nylon e pvc per legacci**
- Maggiore comodità grazie agli elastici regolabili per il fissaggio alla gamba. Con zip di chiusura.

- ☑ **Funda de nylon y pvc para ataduras**
- Mayor comodidad gracias a los elásticos ajustables para la fijación a la pierna. Con cremallera de cierre.

- ☑ **Tasche aus Nylon und Pvc für Bindematerialien**
- Elastische Bänder zum Anbringen der Tasche am Bein für mehr Stabilität. Mit Reißverschluss.

- ☑ **Nylon and pvc pouch bag**
- The adjustable elastics allow to fasten it to the leg for advanced comfort. With zip closure.



- ☑ **Fodero in nylon per legacci**
- ☑ **Funda de nylon para ataduras**
- ☑ **Nylontasche für Bindematerialien**
- ☑ **Nylon pouch bag**

Art.	cm	Gr.	Pz./St.	€	EAN
422	18 x 12 x h 21	178	6	15,80-	8 016604 004223



stocker

www.stockergarden.com

PROTEZIONE

PROTECCIÓN
ABDECKMATERIALIEN
PROTECTION

Art. 4690

205



- ☑ **Protex Tessuto non tessuto in PP**
Bianco
- ☑ **Protex Tejido no tejido de PP**
Blanco
- ☑ **Protex Gartenvlies aus PP**
Weiß
- ☑ **Protex PP non woven**
White

17
gr/m²

Art.	m x m	Gr./m ²	Pz./St.	€	EAN
4507	1,6 x 5 m	17	30	4,10-	8 016604 045073
4503	1,6 x 10 m	17	30	5,50-	8 016604 045035
4511	2 x 10 m	17	30	7,20-	8 016604 045110

- ☑ **Protex Tessuto non tessuto in PP**
Bianco
- ☑ **Protex Tejido no tejido de PP**
Blanco
- ☑ **Protex Gartenvlies aus PP**
Weiß
- ☑ **Protex PP non woven**
White

19
gr/m²

Art.	m x m	Gr./m ²	Pz./St.	€	EAN
4502	1,6 x 5 m	19	30	4,80-	8 016604 832055
4509	4 x 5 m	19	25	8,40-	8 016604 173691
4500	1,6 x 10 m	19	30	7,00-	8 016604 112232
4501	2 x 10 m	19	25	8,70-	8 016604 440014
4508	1,6 x 20 m	19	15	13,10-	8 016604 045080



- ☑ **Protex Tessuto non tessuto invernale in PP**
Bianco
- ☑ **Protex Tejido no tejido invernale de PP**
Blanco
- ☑ **Protex Wintervlies aus PP**
Weiß
- ☑ **Protex winter PP non woven**
White

30
gr/m²



Art.	m x m	Gr./m ²	Pz./St.	€	EAN
4512	1,6 x 5 m	30	30	6,60-	8 016604 201004
4515	1,6 x 10 m	30	20	10,00-	8 016604 045158

- ☑ **Protex Tessuto non tessuto tubolare**
Bianco
- ☑ **Protex Tejido no tejido tubular**
Blanco
- ☑ **Protex Gartenvlies schlauchförmig**
Weiß
- ☑ **Protex tubular non woven**
White

19
gr/m²



Art.	m x m	Gr./m ²	Pz./St.	€	EAN
4506	0,8 x 9 m	19	30	8,80-	8 016604 439544
4514	1,5 x 6 m	19	25	9,40-	8 016604 200052



- ☑ **Protex Tessuto non tessuto in PP**
Bianco
- ☑ **Protex Tejido no tejido de PP**
Blanco
- ☑ **Protex Gartenvlies aus PP**
Weiß
- ☑ **Protex PP non woven**
White

17
gr/m²

Art.	m x m	Gr./m ²	Pz./St.	€	EAN
4468	1,6 x 5 m	17	60	4,10-	8 016604 044687
4469	1,6 x 10 m	17	40	5,50-	8 016604 044694
4470	2 x 10 m	17	30	7,20-	8 016604 044700



- ☑ **Protex Tessuto non tessuto invernale in PP**
Bianco
- ☑ **Protex Tejido no tejido invernale de PP**
Blanco
- ☑ **Protex Wintervlies aus PP**
Weiß
- ☑ **Protex winter PP non woven**
White

19
gr/m²

Art.	m x m	Gr./m ²	Pz./St.	€	EAN
4740 *	1,6 x 10 m	19	24	6,50-	8 016604 047404
4741 *	1,6 x 10 m	19	72	6,40-	8 016604 047411
4738 *	2 x 10 m	19	24	7,90-	8 016604 047381
4739	2 x 20 m	19	12	15,60-	8 016604 047398



- ☑ **Protex Tessuto non tessuto in PP**
Bianco
- ☑ **Protex Tejido no tejido de PP**
Blanco
- ☑ **Protex Gartenvlies aus PP**
Weiß
- ☑ **Protex PP non woven**
White

17
gr/m²

Art.	m x m	Gr./m ²	Pz./St.	€	EAN
4737 *	1,6 x 10 m	17	24	5,60-	8 016604 047374
4735 *	2 x 10 m	17	24	6,90-	8 016604 047350
4736	2 x 20 m	17	12	12,50-	8 016604 047367



- ☑ **Protex Tessuto non tessuto invernale in PP**
Bianco
- ☑ **Protex Tejido no tejido invernale de PP**
Blanco
- ☑ **Protex Wintervlies aus PP**
Weiß
- ☑ **Protex winter PP non woven**
White

30
gr/m²



Art.	m x m	Gr./m ²	Pz./St.	€	EAN
4734 *	1,6 x 10 m	30	12	9,70-	8 016604 047343
4732 *	2 x 10 m	30	24	11,20-	8 016604 047329
4733 *	2 x 20 m	30	12	20,90-	8 016604 047336



- Tessuto non tessuto bianco bobina
- Tejido no tejido blanco bobina
- Gartenvlies weiß Rolle
- White non woven spool

17 gr/m²

Art.	m x m	Gr./m ²	Pz./St.	€	EAN
4516	1,6 x 250 m	17	1	74,30-	8 016604 045165
4517	2 x 250 m	17	1	96,40-	8 016604 045172



- Tessuto non tessuto tubolare bobina
Bianco
- Tejido no tejido tubular bobina
Blanco
- Gartenvlies schlauchförmig Rolle
Weiß
- Tubular non woven spool
White

19 gr/m²

Art.	m x m	Gr./m ²	Pz./St.	€	EAN
4562	0,8 x 100 m	19	1	43,30-	8 016604 045622
4564	1,5 x 100 m	19	1	91,40-	8 016604 045646
4558	0,8 x 500 m	19	1	214,00-	8 016604 045585



- Tessuto non tessuto bianco bobina
- Tejido no tejido blanco bobina
- Gartenvlies weiß Rolle
- White non woven spool

19 gr/m²

* fino ad esaurimento
* hasta agotamiento
* solange der Vorrat reicht
* While supplies last

Art.	m x m	Gr./m ²	Pz./St.	€	EAN
4504	***1,6 x 250 m	19	1	99,10-	8 016604 045042
4505	2 x 250 m	19	1	124,00-	8 016604 045059
4546	**3,2 x 250 m	19	1	198,50-	8 016604 045462
4548	**3,95 x 250 m	19	1	262,00-	8 016604 045486
4524*	*5,2 x 250 m	19	1	282,00-	8 016604 045240



- Tessuto non tessuto bianco bobina
- Tejido no tejido blanco bobina
- Gartenvlies weiß Rolle
- White non woven spool

27 gr/m²

* h rotolo / rollo / Rolle / roll: 2,1 mt
** h rotolo / rollo / Rolle / roll: 2 mt

Art.	m x m	Gr./m ²	Pz./St.	€	EAN
4567	*3,2 x 250 m	27	1	349,00-	8 016604 045677
4541	**3,95 x 250 m	27	1	412,00-	8 016604 045417



- Tessuto non tessuto bianco bobina 2 x 250 m
- Tejido no tejido blanco bobina 2 x 250 m
- Gartenvlies weiß Rolle 2 x 250 m
- White non woven spool 2 x 250 m

30 gr/m²

Art.	m x m	Gr./m ²	Pz./St.	€	EAN
4525	2 x 250 m	30	1	217,00-	8 016604 045257



- Fruit Bag Protezione per frutta
Pratici sacchetti in tessuto non tessuto per proteggere i grappoli d'uva, le mele e altra frutta dall'attacco degli uccelli.
Confezione da 50 sacchetti.

- Fruit Bag Protección para fruta
Prácticas bolsas de tela bioprotectora para proteger los racimos de uva, manzanas y otras frutas del ataque de los pájaros. Confección de 50 bolsas.

- Fruit Bag Schutz für Früchte
Vliesbeutel zum Schutz der Ernte. Schützt Trauben, Äpfel und andere Früchte vor Wespen und Vogelfraß. 50 Stück/Packung.

- 50 x Fruit bag fruit protection
Made from lightweight fabric to protect grapes, apples and other fruits against birds and wasps. 50 pieces per unit.

Art.	cm	Pz./St.	€	EAN
4743	20 x 30 cm	12	15,60-	8 016604 047435



- Tessuto non tessuto tubolare bobina
Bianco
- Tejido no tejido tubular bobina
Blanco
- Gartenvlies schlauchförmig Rolle
Weiß
- Tubular non woven spool
White

19 gr/m²

Art.	m x m	Gr./m ²	Pz./St.	€	EAN
4562	0,8 x 100 m	19	1	43,30-	8 016604 045622
4564	1,5 x 100 m	19	1	91,40-	8 016604 045646
4558	0,8 x 500 m	19	1	214,00-	8 016604 045585

20 cm 10 x

Art.	cm	Gr.	Pz./St.	€	EAN
2166	20 cm		24	6,60-	8 016604 021664

- Picchetti di fissaggio 20 cm
10 picchetti (confezione) = 1 pz.
- Estacas de fijación 20 cm
10 estacas (confección) = 1 pz.
- Folienhalter 20 cm
10 Folienhalter (Verpackung) = 1 St.
- Plastic ground stakes 20 cm
10 per package.

10,5 cm 10 x

Art.	cm	Gr.	Pz./St.	€	EAN
2163	10,5 cm		24	3,20-	8 016604 021633

- Picchetti di fissaggio 10,5 cm
10 picchetti (confezione) = 1 pz.
- Estacas de fijación 10,5 cm
10 estacas (confección) = 1 pz.
- Folienhalter 10,5 cm
10 Folienhalter (Verpackung) = 1 St.
- Plastic ground stakes 10,5 cm
10 per package.

11,5 cm 15 cm 20 cm 10 x

Art.	cm	Gr.	Pz./St.	€	EAN
2162	11,5 cm		24	2,30-	8 016604 021626
2168	15 cm		24	2,70-	8 016604 021688
2169	20 cm		24	3,60-	8 016604 021695

- Picchetti di fissaggio
10 picchetti (confezione) = 1 pz.
- Estacas de fijación
10 estacas (confección) = 1 pz.
- Folienhalter
10 Folienhalter (Verpackung) = 1 St.
- Plastic ground stakes
10 per package.

**Protex Cappuccio protettivo**

Bianco

Protex Funda protectora

Blanco

Protex Pflanzenschutzhaube

Weiß

Protex plant cover

White

17 gr/m² 3 x

Art.	m x m	Gr./m ²	Pz./St.	€	EAN
4510	1 x 1,6 m	17	12	7,20-	8 016604 306679
4513	2 x 2,4 m	17	12	13,30-	8 016604 045134

Protex Cappuccio protettivo

Offre protezione traspirabile a tutti i tipi di piante contro il freddo.

Protex Funda protectora

Ofrece protección transpirable a todos tipos de plantas contra frío.

Protex Pflanzenschutzhaube

Bietet atmungsaktiven Schutz für alle Arten von Pflanzen vor Kälte.

Protex plant cover

Provides protection to all types of plants from frost.

30 gr/m² 2 x

Art.	m x m	col./Farbe	Pz./St.	€	EAN
4746	1,2 x 1,6		34	8,30-	8 016604 047466
4753	1,5 x 2,4		12	13,50-	8 016604 047534
4751	2 x 2,4		12	14,70-	8 016604 047510



** Display

**Protex Cappuccio protettivo**

Offre protezione traspirabile a tutti i tipi di piante contro il freddo.

Protex Funda protectora

Ofrece protección transpirable a todos tipos de plantas contra frío.

Protex Pflanzenschutzhaube

Bietet atmungsaktiven Schutz für alle Arten von Pflanzen vor Kälte.

Protex plant cover

Provides protection to all types of plants from frost.

30 gr/m² 2 x

Art.	m x m	col./Farbe	Pz./St.	€	EAN
4767*	2 x 2,4	□	12	14,50-	8 016604 047671
4768	2 x 2,4	□	12	11,90-	8 016604 047688
4742**	1,5 x 3,6		12	16,00-	8 016604 047428

* con corda
 * con cuerda
 * mit Band
 * with ribbon tie

Protex Cappuccio protettivo 1,8 x 2 m

Offre protezione traspirabile a tutti i tipi di piante contro il freddo.

Protex Funda protectora 1,8 x 2 m

Ofrece protección transpirable a todos tipos de plantas contra frío.

Protex Pflanzenschutzhaube 1,8 x 2 m

Bietet atmungsaktiven Schutz für alle Arten von Pflanzen vor Kälte.

Protex plant cover 1,8 x 2 m

Provides protection to all types of plants from frost.

45 gr/m² 2 x

Art.	m x m	col./Farbe	Pz./St.	€	EAN
4747	1,8 x 2		12	15,90-	8 016604 047473

**Jutebag Sacco in juta**

In fibra di iuta biodegradabile al 100%. Rappresenta una protezione ottimale contro il freddo.

Jutebag Saco de yute

En fibra de yute biodegradable 100%. Ofrece una protección óptima contra el frío.

Jutebag Jutesack

Aus 100% biologisch abbaubaren Jutefasern. Bietet Pflanzen optimalen Schutz gegen Kälte.

Jute bag

Made from 100% biodegradable jute material, this bag provides long lasting protection for plants against the frost.

Art.	cm x cm	col./Farbe	Pz./St.	€	EAN
4690	60 x 80 cm		24	5,40-	8 016604 046902
4691	60 x 110 cm		24	6,60-	8 016604 046919
4689	100 x 110 cm		24	10,20-	8 016604 046896
4692	98 x 110 cm		24	11,20-	8 016604 046926
4693	100 x 160 cm		24	13,60-	8 016604 046933
4694	98 x 160 cm		24	14,90-	8 016604 046940

**Protex Telo in juta**

In fibra di iuta biodegradabile al 100%. Rappresenta una protezione ottimale contro il freddo.

Protex Telo de yute

En fibra de yute biodegradable 100%. Ofrece una protección óptima contra el frío.

Protex Jutegewebematte

Aus 100% biologisch abbaubaren Jutefasern. Bietet Pflanzen optimalen Schutz gegen Kälte.

Protex jute fabric

Made from 100% biodegradable jute material, this bag provides long lasting protection for plants against the frost.

Art.	m x m	col./Farbe	Pz./St.	€	EAN
4684	1 x 5 m		12	20,40-	8 016604 046841
4685	0,98 x 5 m		24	20,40-	8 016604 046858

**Protex Stuoia di cocco**

In fibra di cocco al 100% biodegradabile. Protegge contro il gelo. Adatto in casa e in giardino.

Protex Esterilla de coco

En fibra de coco biodegradable 100%. Protege contra las heladas. Apta para la casa y el jardín.

Protex Kokosmatte

Aus 100% biologisch abbaubaren Kokosfasern. Schützt vor Frost. Vielseitige Anwendungsmöglichkeiten in Haus und Garten.

Protex jute felt

Made from 100% biodegradable coconut fiber. Protects the plant against frost. Can be used in house and garden.

Art.	m x m	Gr./m ²	Pz./St.	€	EAN
4655	0,5 x 1,5 m	700	12	12,90-	8 016604 046551

**Protex Telo pacciatura**

Nero

Protex Tejido acolchado

Negro

Protex Unkrautvlies

Schwarz

Protex mulch foil

Black

50 gr/m²

Art.	m x m	Gr./m ²	Pz./St.	€	EAN
4563	0,8 x 5 m	50	30	6,70-	8 016604 163333
4565	1,6 x 5 m	50	25	12,40-	8 016604 155840
4553	1,6 x 10 m	50	15	24,30-	8 016604 045530
4566	2 x 10 m	50	16	25,40-	8 016604 045660



- Tessuto non tessuto bobina Nero**
- Tejido no tejido bobina Negro**
- Unkrautvlies Rolle Schwarz**
- Non woven spool Black**

50 gr/m²

Art.	m x m	Gr./m²	Pz./St.	€	EAN
4560	0,8 x 250 m	50	1	142,00-	8 016604 045608
4561	1,6 x 250 m	50	1	284,00-	8 016604 045615
4555	2 x 250 m	50	1	354,00-	8 016604 045554

Protex Telo per pacciamatura
Impedisce il formarsi di erbacce senza l'uso di prodotti chimici. Permette la penetrazione di acqua e umidità. Mantiene il suolo umido. Per aiuole e sentieri.

Protex Tejido para acolchado
Impide la formación de malezas sin uso de productos químicos. Permite que el agua y la humedad penetren. Mantiene el suelo húmedo. Para caminos y parterres.

Protex Unkrautvlies
Stoppt Unkrautwuchs ohne Chemie. Lässt Wasser und Feuchtigkeit durch. Hält die Erde feucht. Für Beete und Wege.

Protex mulch foil
Prevents weeds from growing. Allows water and moisture for the soil. For flowerbeds and paths.



50 gr/m²



Art.	m x m	Gr./m²	Pz./St.	€	EAN
4730	2 x 10 m	50	12	20,50-	8 016604 047305
4731	2 x 20 m	50	12	38,10-	8 016604 047312



Telo pacciamatura cocco 1,2 x 42 m
Tessuto pacciamante composto da uno strato di telo microforato con l'aggiunta di uno strato di fibra di cocco.

Tejido acolchado coco 1,2 x 42 m
Tejido compuesto de una capa de tela microperforada en conjunto con otra capa de fibra de coco.

Mulchmatte Kokos 1,2 x 42 m
100% Kokosfaser-Auflage. Untenliegende, aufgeklebte, schwarze Porenfolie mit PP-Netz verstept.

PP coconut mulch foil 1,2 x 42 m
Upper part: 100% coconut fiber. Lower part: black porosity foil with PP net.

Art.	m x m	Gr./m²	Pz./St.	€	EAN
4659	1,2 x 42 m	600	1	381,00-	8 016604 046599



Telo pacciamatura in PP
Impedisce la crescita di piante infestanti evitando l'uso di erbicidi.

Tejido acolchado de PP
Impide el pasaje de la luz evitando así el crecimiento de hierba invadiente.

Mulchfolie aus PP
Verhindert das Wachsen von Unkraut, ohne Herbizide anzuwenden.

PP mulch foil
Prevents the growth of weeds without herbicides.

Art.	m x m	Gr./m²	Pz./St.	€	EAN
4663	1 x 10 m		12	22,30-	8 016604 046636
4664	1 x 20 m		8	34,60-	8 016604 046643



Telo pacciamatura biodegradabile
Nero. Durata da 4-6 mesi. Riduce la produzione di rifiuti plastici. Non provoca inquinamento del suolo.

Tejido acolchado biodegradable
Negro. Dura de 4-6 meses. Reduce la producción de residuos plásticos. No causa la contaminación del suelo.

Biologisch abbaubare Mulchfolie
Schwarz. Dauer: 4-6 Monate. Reduziert Plastikabfälle. Der Boden wird nicht mit Rückständen verschmutzt.

Biodegradable mulch foil
Black. Duration: 4-6 months. Reduces plastic waste. Does not cause soil pollution.

18 µm (micrometer) eco

Art.	m x m	µm	Pz./St.	€	EAN
4860	0,8 x 5 m	18	25	6,70-	8 016604 048602
4861	0,8 x 10 m	18	25	9,30-	8 016604 048616
4862	1,4 x 5 m	18	25	8,30-	8 016604 048626
4863	1,4 x 10 m	18	25	12,50-	8 016604 048630



Telo pacciamatura biodegradabile bobina
Nero. Durata da 4-6 mesi. Riduce la produzione di rifiuti plastici. Non provoca inquinamento del suolo.

Tejido acolchado biodegradable bobina
Negro. Dura de 4-6 meses. Reduce la producción de residuos plásticos. No causa la contaminación del suelo.

Biologisch abbaubare Mulchfolie Rolle
Schwarz. Dauer: 4-6 Monate. Reduziert Plastikabfälle. Der Boden wird nicht mit Rückständen verschmutzt.

Biodegradable mulch foil spool
Black. Duration: 4-6 months. Reduces plastic waste. Does not cause soil pollution.

18 µm (micrometer) eco

Art.	m x m	µm	Pz./St.	€	EAN
4864	0,8 x 100 m	18	1	30,10-	8 016604 048647
4865	0,8 x 250 m	18	1	75,30-	8 016604 048654
4866	1,4 x 100 m	18	1	53,70-	8 016604 048661
4867	1,4 x 250 m	18	1	132,00-	8 016604 048678



Biotessuto in juta 1,22 x 50 m
Con funzione antierosiva e biodegradabile, adatto al rinverdimento delle scarpate.

Biotejido de yute 1,22 x 50 m
Con función anti erosiva, biodegradable, idóneo para el reverdecimiento de los pendientes escarpados.

Böschungsschutz in Jute 1,22 x 50 m
Als Erosionsschutz bei Böschungsanlagen. Schweres Material.

Bio jute fabric 1,22 x 50 m
Prevents soil erosion. For new embankments and bank reinforcement.

Art.	m x m	Gr./m²	Pz./St.	€	EAN
4681	1,22 x 50 m	500	10	111,50-	



Protex Protezione per pendii

In fibra di iuta biodegradabile al 100%.

Protex Protección para pendientes
En fibra de yute biodegradable 100%.

Protex Böschungs-Schutz in Jute
Aus 100% biologisch abbaubaren Jutefasern.

Protex embankment protection
100% biodegradable.

Art.	m x m	Gr./m²	Pz./St.	€	EAN
4680	1 x 100 m	250	1	352,00-	8 016604 046803
4679	1 x 100 m	190	1	277,00-	8 016604 046797

Disco pacciamatura in iuta

In fibra di iuta e lana. Trattiene l'umidità - impedisce la crescita delle erbacce.

Disco acolchado de yute
En fibra de yute y lana. Retiene la humedad, impide el crecimiento de las malezas.

Mulchscheibe aus Jute
Aus Jutefasern und Wolle. Verhindert die Unkrautbildung und hält die Feuchtigkeit.

Jute mulching disc
Made from jute and wool. Prevents weed and moisture loss.

Art.	cm x cm	Gr./m²	Pz./St.	€	EAN
4600	45 x 45	600	50	1,95-	8 016604 046001
4650	55 x 55	600	50	3,00-	8 016604 046506

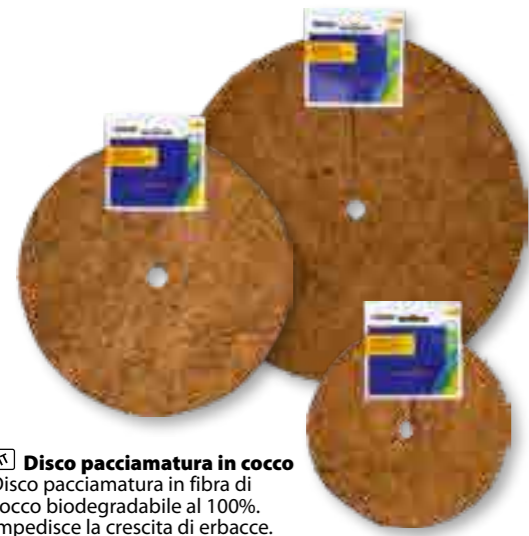

Disco pacciamatura in cocco

Disco pacciamatura in fibra di cocco biodegradabile al 100%. Impedisce la crescita di erbacce.

Disco acolchado de coco
Disco ecológico in fibra de coco biodegradable al 100%. Impide el crecimiento de malezas.

Kokosmatte
Mulchscheibe aus 100% biologisch abbaubaren Kokosfasern. Verhindert die Unkrautbildung. Hält die Feuchtigkeit.

Coconut mulching disc
Made of coconut fibers. Shuts out the moisture. 100% biodegradable.

Art.	Ø cm	Gr./m²	Pz./St.	€	EAN
4652	25 cm	700	24	6,60-	8 016604 046520
4653	35 cm	700	24	9,40-	8 016604 046537
4654	45 cm	700	24	12,10-	8 016604 046544

Disco pacciamatura in iuta

In fibra di iuta. Trattiene l'umidità e impedisce la crescita dell'erbacce.

Disco acolchado de yute
De fibra de yute. Retiene la humedad y impide el crecimiento de las malezas.

Mulchscheibe aus Jute
Aus 100% biologisch abbaubaren Jutefasern. Verhindert die Unkrautbildung und hält die Feuchtigkeit.

Jute mulching disc
Made of 100% biodegradable jute. Prevents weed and moisture loss.

Art.	Ø cm	Gr./m²	Pz./St.	€	EAN
4611	45 cm	250	200	1,30-	8 016604 046117
4612	55 cm	250	200	1,95-	8 016604 046124

Protect Kit Serra Tunnel
Kit incluso di: 3 archi in plastica, telo in polietilene 1,8 x 3 m, 2 picchetti per fissare il telo nel terreno, 9 clips per il fissaggio del telo e degli archi.



Protect Kit Invernadero Túnel
Kit incluso de: 3 arcos de plástico, cubierta de polietileno 1,8 x 3 m, 2 estacas para fijar la tela, 9 clips para la fijación de la tela y de los arcos.

Protect Kit Folientunnel
Kit inklusive: 3 Kunststoffstäbe, Polyethylen-Folie 1,8 x 3 m, 2 Fixierhaken zum Befestigen der Frühbeet-Folie im Erdreich, 9 Clips zum Fixieren an den Kunststoffstäben.

Protect kit tunnel
Kit includes: 3 plastic rods, polyethylene film 1.8 x 3 m, 2 hooks to attach to the ground, 9 clips to secure the rods.

* fino ad esaurimento
* hasta agotamiento
* solange der Vorrat reicht
* While supplies last

Art.	m x m	Pz./St.	€	EAN
9627	0,5 x 3 m	12	11,80-	8 016604 096273

Archi per tunnel

In acciaio plastificato e particolarmente resistenti possono supportare diversi tipi di teli (tessuto non tessuto, reti ombreggianti, rete anti insetti, ecc). Sono incluse 3 clips di fissaggio per ogni arco.



Arcos para túnel

Hecho de acero plastificado, muy resistente pueden cargar diferentes tipos de tejidos. (bioprotectores, mallas sombreadoras, mallas anti-insectos etc.). 3 clips de fijaje para cada arco.

Federstahlstäbe für Tunnel

Aus plastifiziertem Stahl, ideal in Kombination mit Gartenvliesen, Schattennetzen, Insekten-Schutz-Netzen, usw. 3 Befestigungs-Clips je Bogen inklusive.

Frames for tunnel

Made of steel. The covering is made of plastic. Can be combined with non-woven material, shadow nets or insect-nets. Each arch is provided with 3 fastening clips.

Art.	cm x cm	Ø mm	conf.	Pz./St.	€	EAN
9651	h 45 x 55 cm	11 mm	4	12	10,60-	8 016604 096518
9650	h 60 x 65 cm	11 mm	4	12	13,50-	8 016604 096501
9652	h 52 x 88 cm	11 mm	4	12	13,80-	8 016604 096525
9618	h 80 x 100 cm	11 mm	4	12	16,50-	8 016604 096181



Spugna per fiori freschi
Esponja para flores frescas
Steckschaum für frische Blumen
Foam for fresh flowers

Art.	cm	Pz./St.	€	EAN
21038	23 x 11 x h 7 cm	48	3,20-	8 016604 210389

Protect Kit Serra anti-insetti
Kit incluso di: 3 archi in plastica, rete anti insetti 1,8 x 3 m, picchetti per il fissaggio della rete nel terreno, 9 clips per il fissaggio della rete agli archi.



Protect Kit Invernadero anti insectos
Kit incluso de: 3 arcos de plástico, red anti-insectos 1,8 x 3 m, estacas para fijar la red al terreno, 9 clips para fijar la red y los arcos.

Protect Kit Gewächshaus Anti-Insekten
Kit inklusive: 3 Kunststoffstäbe, Insekten-Netz 1,8 x 3 m, Fixierhaken zum Befestigen der Folie im Erdreich, 9 Clips zum Fixieren des Netzes an den Stäben.

Protect kit anti-insect tunnel
Kit includes: 3 plastic rods, insect net 1.8 x 3 m, hooks to attach the net to the ground, 9 clips to secure the net.

* fino ad esaurimento
* hasta agotamiento
* solange der Vorrat reicht
* While supplies last

Art.	m x m	Pz./St.	€	EAN
9628	0,5 x 3 m	12	15,30-	8 016604 096280

Misuratore combi per suolo

3-in-1 Misuratore per suolo:
- Valore indicativo dell'umidità vicino alle radici
- Valore pH del suolo
- Luminosità (all'esterno)
Funziona senza corrente o batterie.



Medidor combi para suelo

3-in-1 medidor para suelo:
- valor indicativo de la humedad alrededor de las raíces
- valor pH del suelo
- luminosidad (al aire libre)
Funciona sin pilas y sin corriente.

Kombi Bodenmessgerät

3-in-1 Messgerät: Anhaltswert für Feuchtigkeit an der Wurzel, pH-Wert der Erde, Standort-Helligkeit (nur für Außenbereich). Strom- und batteriefrei.

Combi soil tester

3-in-1 Soil Tester: humidity value for root-zone, soil pH value, light intensity of position (only for outdoor areas). Battery and current-free.

Art.	cm	Gr.	Pz./St.	€	EAN
9646			6	21,50-	8 016604 096464

Spugna per fiori secchi
Esponja para flores secas
Foamschaum für getrocknete Blumen
Foam for dried flowers



Art.	cm	Pz./St.	€	EAN
21039	23 x 11 x h 7 cm	48	4,00-	8 016604 210396



- Rete antiuccelli
- Red anti pájaros
- Vogelschutz-Netz
- Bird netting

Art.	m x m	Gr./m ²	Pz./St.	€	EAN
4570	2 x 5 m	7	12	4,30-	8 016604045707
4574	4 x 5 m	8-9	24	7,20-	8 016604045745
4572	2 x 10 m	7	12	6,90-	8 016604045721
4576	4 x 10 m	8-9	12	14,20-	8 016604045769



- Rete antigrandine
- Red antigranizo
- Hagelschutznetz
- Hail protection net

Art.	m x m	Gr./m ²	Pz./St.	€	EAN
4750	2 x 10 m	45	6	21,20-	8 016604047503
4754	4 x 10 m	45	6	41,60-	8 016604047541
4752	2 x 20 m	45	6	41,60-	8 016604047527



- Rete rampicante
- Red trepadora
- Ranken-Netz
- Creeper plants support netting

Art.	m x m	Gr./m ²	Pz./St.	€	EAN
4577 *	1,2 x 10 m		40	6,50-	8 016604045776
4581 *	1,2 x 25 m		36	10,40-	8 016604045813
4583 *	1,2 x 50 m		16	17,60-	8 016604045837
4589	1,5 x 25 m		25	13,50-	8 016604045899
4587	1,5 x 50 m		12	23,50-	8 016604045875
4588	1,5 x 100 m		6	37,40-	8 016604045882
4520	2 x 5 m		50	5,30-	8 016604045202
4578	2 x 10 m		30	7,00-	8 016604045783
4579	2 x 25 m		20	15,70-	8 016604045790
4580	2 x 50 m		12	28,80-	8 016604045806
4582	2 x 100 m		6	42,85-	8 016604045820
4585	2 x 500 m		1	187,00-	8 016604045851



Con fori occhiali e rinforzati sul bordo. Con foros botoneados y fortificados a los bordes. Mit verstärkten Knopflöchern am Saum. Extra strength protection ring to hold the netting in place.



- Rete ombreggiante 2 x 10 m
- Ombreggiante 75%

- Red sombreadora 2 x 10 m
- Sombreadora 75%

- Schatten-Netz 2 x 10 m
- Beschattung 75%

- Shadow net 2 x 10 m
- Shading 75%

Art.	m x m	col./Farbe	Pz./St.	€	EAN
4596	2 x 10 m		6	41,40-	8 016604045967



- Clips di fissaggio
- In plastica, per fissare reti ombreggianti, antiuccelli o di protezione contro la grandine. 6 Clips (confezione) = 1 pz.

- Clips de fijación
- de plástico para fijar mallas sombreadoras, mallas anti-pájaros y mallas antigranizo. 6 Clips (confección) = 1 pz.

- Fixierclips
- in Kunststoff, zum fixieren von Schatten netzen, Vogelnetzen und Hagelnetzen. 6 Clips (Verpackung) = 1 St.

- Fixing clips
- Plastic clips for securing nets. Used for bird and hail nets. Six clips per package.

Art.	mm x mm	Gr.	Pz./St.	€	EAN
2165			12	2,30-	8 016604021657

COMMUNITY DI APPASSIONATI DEL VERDE:

Trasmettere conoscenze e creare una rete di appassionati della potatura e della cura del verde.

Il consumatore finale cerca esperienze, non solo prodotti!

Tramite l'esperienza pratica e diretta del prodotto il cliente si fidelizza al prodotto e al marchio!

www.stockergarden.com/eventi-servizio/eventi/

COMMUNITY OF GREEN ENTHUSIASTS:

Passing on knowledge and creating a network of pruning and green care enthusiasts.

The end consumer is looking for experiences, not just products!

Through the practical and direct experience of the product, the customer gains loyalty to the product and the brand!



**PUOI ORGANIZZARE CORSI
CON NOI, SCRIVICI PER
SAPERE DI PIÙ**

info@stockergarden.com



Vasoio miniserra con 12 vasetti
Per la coltivazione facile di giovani piantine.
1 x 12 vasetti.

Bandeja mini invernadero con 12 macetas
Para cultivar fácilmente plantas jóvenes.
1 x 12 macetas.

Treibhaus mit Topfplatte 12 Töpfe
Für optimale Jungpflanzenanzucht.
1 x 12 Kunststofftöpfe.

12 x Seed tray 12 pots
Ideal to grow young plants.
1 x 12 plastic pots.

Art.	cm	Pz./St.	€	EAN
9623	20 x 14,5 x h 11 cm	12	5,10-	8 016604 096235



Vasoio miniserra con 40 vasetti
Per la coltivazione facile di giovani piantine.
1 x 40 vasetti.

Bandeja mini invernadero con 40 macetas
Para cultivar fácilmente plantas jóvenes.
1 x 40 macetas.

Treibhaus mit Topfplatte 40 Töpfe
Für optimale Jungpflanzenanzucht.
1 x 40 Kunststofftöpfe.

40 x Seed tray 40 pots
Ideal to grow young plants.
1 x 40 plastic pots.

Art.	cm	Pz./St.	€	EAN
9624	37 x 24 x h 11 cm	6	13,00-	8 016604 096242



Semanzio in plastica
Per art. 9622 e 9623.
Set 6 x 12 per 72 vasetti.

Semillero de plástico
Para ref. 9622 y 9623.
Set 6 x 12 para 72 macetas.

Saatbeet aus Plastik
Für Art. 9622 und 9623.
Set 6 x 12 für 72 Töpfe.

6 x 12 Plastic seedbed
For art. 9622 and 9623.
Set 6 x 12 for 72 pots.

Art.	cm	Pz./St.	€	EAN
9642	18 x 13,5 x h 5,5 cm	12	5,30-	8 016604 096426



Vasetti di torba acquistabili separatamente!
Las macetas de turba, se pueden adquirir por separado.
Torftöpfchen sind nachkaufbar!
The peat pots can be purchased separately.

Vasoio miniserra con vasetti di torba
Per la coltivazione facile di giovani piantine.
Impiantare l'intero vasetto di torba nella terra.
Set 3 x 12 per 36 vasetti.

Bandeja mini invernadero con macetas de turba
Para cultivar fácilmente plantas jóvenes.
Plantar la entera maceta de turba en la tierra.
Set 3 x 12 para 36 macetas.

Treibhaus mit Torftöpfen
Für optimale Jungpflanzenanzucht.
Anzucht in Torftöpfen. Pflanzen samt Torftopf auspflanzen.
Set 3 x 12 für 36 Torftöpfe.

36 x Seed tray with peat pots
Ideal to grow young plants.
Plant out complete pot.
Set 3 x 12 for 36 pots.

Art.	cm	Pz./St.	€	EAN
9625	55,5 x 14,5 x h 12 cm	6	11,50-	8 016604 096259



Semanzio in plastica
Per art. 9624.
Set 6 x 40 per 240 vasetti.

Semillero de plástico
Para ref. 9624.
Set 6 x 40 para 240 macetas.

Saatbeet aus Plastik
Für Art. 9624.
Set 6 x 40 für 240 Töpfe.

6 x 40 Plastic seedbed
For art. 9624.
Set 6 x 40 for 240 pots.

Art.	cm	Pz./St.	€	EAN
9643	4 x 4 x h 5 cm	12	13,20-	8 016604 096433



Vasoio miniserra con 36 vasetti
Per la coltivazione facile di giovani piantine.
Set 3 x 12 per 36 vasetti.

Bandeja mini invernadero con 36 macetas
Para cultivar fácilmente plantas jóvenes.
Set 3 x 12 para 36 macetas.

Treibhaus mit Topfplatte 36 Töpfe
Für optimale Jungpflanzenanzucht.
Set 3 x 12 für 36 Torftöpfe.

36 x Seed tray 36 pots
Ideal to grow young plants.
Set 3 x 12 for 36 pots.

Art.	cm	Pz./St.	€	EAN
9622	55,5 x 14,5 x h 11 cm	6	11,20-	8 016604 096228



Set vasetti in fibra di torba
Ideale per la coltivazione di giovani piantine. Impiantare l'intero vasetto di torba nella terra. Set 12 x 12 per 144 vasetti.

Set macetas de fibra de turba
Ideal para el crecimiento de plantas jóvenes.
Plantar la entera maceta de turba en la tierra.
Set 12 x 12 para 144 macetas.

Set Torftöpfe
Für optimale Jungpflanzenanzucht. Die Pflanzen samt Topf auspflanzen. Set 12 x 12 für 144 Torftöpfe.

12 x 12 Peat fibre pots set
Ideal to grow young plants.
Plant out complete pot.
Set 12 x 12 for 144 square pots.

Art.	cm	Pz./St.	€	EAN
9635	12 x 16 x h 4,5 cm	12	6,10-	8 016604 096358



Vasetti in fibra di torba
Impiantare l'intero vasetto di torba nella terra.
1 x 12 vasetti.

Macetas de fibra de turba
Plantar la entera maceta de turba en la tierra.
1 x 12 macetas.

Torftröpfe
Die Pflanzen samt Topf auspflanzen.
1 x 12 Torftöpfe.

12 x Peat fibre pots
Plant out complete pot.
1 x 12 pots.

Art.	cm	Pz./St.	€	EAN
9633	8 x 8 x h 8 cm	24	3,70-	8 016604 096334



Set vasetti in fibra di torba

Ideale per la coltivazione di giovani piantine. Impiantare l'intero vasetto di torba nella terra. Set 12 x 10 per 120 vasetti.

Set macetas de fibra de turba

Ideal para el crecimiento de plantas juvenes. Plantar la entera maceta de turba en la tierra. Set 12 x 10 para 120 macetas.

Set Torftöpfe

Für optimale Jungpflanzenanzucht. Die Pflanzen samt Topf auspflanzen. Set 12 x 10 für 120 Torftöpfe.

12 x 10 Peat fibre pots set
Ideal to grow young plants. Plant out complete pot.
Set 12 x 10 for 120 square pots.

Art.	cm	Pz./St.	€	EAN
9634	22 x 8 x h 6 cm	12	6,00-	8 016604 096341



Vasetti in fibra di torba

Impiantare l'intero vasetto di torba nella terra. 1 x 12 vasetti.

Macetas de fibra de turba

Plantar la entera maceta de turba en la tierra. 1 x 12 macetas.

Torftöpfe

Die Pflanzen samt Topf auspflanzen. 1 x 12 Torftöpfe.

12 x Peat fibre pots
Plant out complete pot.
1 x 12 pots.

Art.	cm	Pz./St.	€	EAN
9630	Ø 6 x h 6 cm	24	3,40-	8 016604 096303



Vasetti in fibra di torba

Impiantare l'intero vasetto di torba nella terra. 1 x 12 vasetti.

Macetas de fibra de turba

Plantar la entera maceta de turba en la tierra. 1 x 12 macetas.

Torftöpfe

Die Pflanzen samt Topf auspflanzen. 1 x 12 Torftöpfe.

12 x Peat fibre pots
Plant out complete pot.
1 x 12 pots.

Art.	cm	Pz./St.	€	EAN
9632	6 x 6 x h 9 cm	24	3,70-	8 016604 096327



Vasetti in fibra di torba

Impiantare l'intero vasetto di torba nella terra. 1 x 12 vasetti.

Macetas de fibra de turba

Plantar la entera maceta de turba en la tierra. 1 x 12 macetas.

Torftöpfe

Die Pflanzen samt Topf auspflanzen. 1 x 12 Torftöpfe.

12 x Peat fibre pots
Plant out complete pot.
1 x 12 pots.

Art.	cm	Pz./St.	€	EAN
9631	Ø 8 x h 8 cm	24	3,70-	8 016604 096310

Cialde in fibra di cocco

Ideali per la semina in vassoi miniserra. 100% biodegradabili. 1 x 12 cialde.

Pastillas de fibra de coco

Ideales para la siembra en bandejas mini invernadero. 100% biodegradables. 1 x 12 pastillas.

Kokos-Quelltabs

Ideal für die Aussaat in Minitreibhäusern. 100% biologisch abbaubar. 1 x 12 Tabs.

Coconut fibre tablets

Ideal for sowing in seed-trays. 100% biodegradable. 1 x 12 tabs.



12 x



Art.	cm	Pz./St.	€	EAN
9637	Ø 3,5	12	5,00-	8 016604 096372



Dosatore di semi

Dosificador de semillas

Saatspender

Seed dispenser



* fino ad esaurimento
* hasta agotamiento
* solange der Vorrat reicht
* While supplies last

Art.	cm	Gr.	Pz./St.	€	EAN
9644			12	6,50-	8 016604 096440



Set completo per la semina

Attrezzi per la preparazione della terra, dosatore di semi, setaccio.

Set completo para la siembra

Herramientas para la preparación de la tierra para sembrar, medidor de semillas, cernidor de jardín.

Komplettes Pikier-Set

Pikierwerkzeug, Saatspender, Sieb.

Planting set

Dibber and widgee, Seed dispenser, Garden riddle.



* fino ad esaurimento
* hasta agotamiento
* solange der Vorrat reicht
* While supplies last

Art.	cm	Gr.	Pz./St.	€	EAN
9645			6	10,80-	8 016604 096457

Etichette per piante

In plastica robusta. Resistenti alle intemperie.

Etiquetas para plantas

En plástico robusto. Resistente a la intemperie.

Pflanzenetiketten

Aus robustem Kunststoff. Wetterfest.

Plant markers

Made from sturdy plastic for long lasting use. Weather proof.



1,3 x 10 cm 20 x

Art.	cm	Pz./St.	€	EAN
220	1,3 x h 10 cm	12	4,10-	8 016604 102202

Etichette per piante

In plastica robusta. Resistenti alle intemperie.

Etiquetas para plantas

En plástico robusto. Resistente a la intemperie.

Pflanzenetiketten

Aus robustem Kunststoff. Wetterfest.

Plant markers

Made from sturdy plastic for long lasting use. Weather proof.



6 x 15 cm 10 x 9 x 34 cm 10 x

Art.	cm	Pz./St.	€	EAN
213	6 x h 15 cm	12	4,30-	8 016604 002137
221	9 x h 34 cm	12	6,80-	8 016604 002212



- Gufo spaventapasseri
- Búho espantapájaros
- Vogelschreck Eule
- Scarecrow owl



Art.	cm x cm	Pz./St.	€	EAN
4526	16 x 17 x h 37,5 cm	4	24,40-	8 016604 045264



- Falco Spaventapasseri
- Halcón espantapájaros
- Vogelschreck Falke
- Scarecrow falcon

Art.	cm x cm	Pz./St.	€	EAN
4538	54 x 36 x h 9 cm	4	19,10-	8 016604 045387



- Corvo spaventapasseri
- Adatto ad allontanare uccelli da alberi, frutteti e vigneti.

- Cuervo espantapájaros
- Ideal para espantar pájaros de los árboles, huertos y viñedos.

- Vogelschreck Krähe
- Verschreckt Vögel von Bäumen, Obstgärten und Weingütern.

- Scarecrow
- Scares birds away from trees, orchards and vineyards.

Art.	cm x cm	Pz./St.	€	EAN
4539	43 x 14 x h 24 cm	6	9,80-	8 016604 045394



- Corvo spaventapasseri
- Cuervo espantapájaros
- Vogelschreck Krähe
- Scarecrow

Art.	cm x cm	Pz./St.	€	EAN
4528	80 x 43,5 x h 9 cm	4	20,30-	8 016604 045288



- Spaventapasseri elicoidale
- Espantapájaros helicoidal
- Vogelschreck Twister
- Twister scarecrow



Art.	cm	Gr.	Pz./St.	€	EAN
45112	49 cm	60	6	8,30-	8 016604 451126



- Spaventapasseri a pallone
- Per allontanare gli uccelli da alberi, frutteti e vigneti.

- Espantapájaros de balón
- Para espantar los pájaros de los árboles, huertos y viñedos.

- Vogelschreck Ballon
- Verschreckt Vögel von Bäumen, Obstgärten und Weingütern.

- Balloon scarecrow
- Frightens birds away from trees, fruit orchards, and vineyards.

Art.	cm	col./Farbe	Pz./St.	€	EAN
45108	Ø 40	■	12	12,50-	8 016604 451089
45109	Ø 40	□	12	12,50-	8 016604 451096

- Strisce spaventapasseri
- Strisce di alluminio.

- Tiras espantapájaros
- Tiras de aluminio.

- Vogelschreck-Band
- Aluminium-Streifen.

- Aluminium scarecrow
- Aluminium stripes.

20 x

Art.	cm x cm	Pz./St.	€	EAN
4536	29,5 x 5 cm	48	8,50-	8 016604 693762



- Dissuasori per uccelli con 30 aghi
- Soluzione ideale per allontanare ogni tipo di volatile. Aghi in acciaio inox.

- Espantapájaros con 30 agujas
- Solución ideal para espantar cualquier tipo de volátiles. Agujas en acero inox.

- Vogelschreck mit 30 Spikes
- Ideale Lösung zur Abwehr von Vögeln jeglicher Art. Spikes aus Inox-Stahl.

- Bird spikes with 30 spikes
- To discourage and prevent birds from landing, especially pigeons. Spikes made of stainless steel.

Art.	cm	Pz./St.	€	EAN
44107	50 cm	20	4,50-	8 016604 441073



- Nastro spaventapasseri
- Rotolo

- Cinta espantapájaros
- Rollo

- Vogelschreck-Band
- Rolle

- Scarecrow band
- Roll

Art.	m	Pz./St.	€	EAN
4535	100 m	24	13,90-	8 016604 295720



- Dissuasori per uccelli con 50 aghi
- Soluzione ideale per allontanare ogni tipo di volatile. Aghi in acciaio inox.

- Espantapájaros con 50 agujas
- Solución ideal para espantar cualquier tipo de volátiles. Agujas en acero inox.

- Vogelschreck mit 50 Spikes
- Ideale Lösung zur Abwehr von Vögeln jeglicher Art. Spikes aus Inox-Stahl.

- Bird spikes with 50 spikes
- To discourage and prevent birds from landing, especially pigeons. Spikes made of stainless steel.

Art.	cm	Pz./St.	€	EAN
44108	50 cm	20	5,80-	8 016604 441080



- Fascia di protezione per alberi
- Protegge il tronco da danni provocati da animali. 2 pezzi.

- Faja de protección para árboles
- Protege el tronco de daños causados por animales. 2 unidades.

- Wildfraß-Schutz
- Schützt den Baumstamm vor Schäden, welche von Tieren verursacht werden. 2 Stück.

- Tree protection band
- Protects the tree from damage caused by animals. Two included.

Art.	cm	Pz./St.	€	EAN
4638	h 50 cm	12	6,60-	8 016604 046384

* fino ad esaurimento
 * hasta agotamiento
 * solange der Vorrat reicht
 * While supplies last



- Recinto resistente
- Recinto resistente
- Beet-Einfassung
- Lawn fencing

15 cm x 9 m
 20 cm x 9 m

Art.	cm x cm	Pz./St.	€	EAN
21045	15 x 900 cm	6	11,30-	8 016604 210457
21047	20 x 900 cm	6	14,10-	8 016604 210471



☑ **Trappole per topi**
In plastica.

☑ **Trampas para ratones**
En plástico.

☑ **Mausefalle**
Aus Kunststoff.

☑ **Mouse trap**

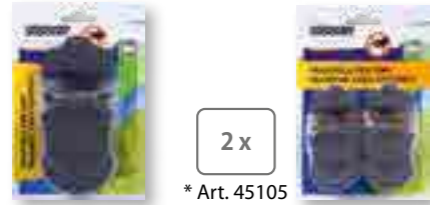

Art.	cm x cm	Pz./St.	€	EAN
45105	9,7 x 4,5 x 4,5 cm	12*	2,40-	8 016604 451058
45106	14,5 x 7 x 7 cm	12	2,40-	8 016604 451065



☑ **Mouse Station S**
☑ **Mouse Station S**
☑ **Mouse Station S**
☑ **Mouse station S**

Art.	cm x cm	Pz./St.	€	EAN
45125	12,5 x 9,5 x h 4 cm	12	5,70-	8 016604 451256



☑ **Mouse Station**
☑ **Mouse Station**
☑ **Mouse Station**
☑ **Mouse station**

Art.	cm x cm	Pz./St.	€	EAN
45126	23 x 18 x h 9,5 cm	12	16,40-	8 016604 451263
45127	33 x 22 x h 10 cm	12	21,00-	8 016604 451270



☑ **Trappola per lumache**
☑ **Trampa para caracoles**
☑ **Schneckenfalle**
☑ **Snail trap**

Art.	cm	Gr.	Pz./St.	€	EAN
21043			6	8,40-	8 016604 210433



☑ **Trappola per vespe**
Appendere all'aperto.
Riempiere di liquido zuccherato.

☑ **Trampa para avispas**
Colgar al aire libre. Llenar de líquido azucarado.

☑ **Wespenfalle**
Im Freien aufhängen. Mit Zuckerwasser füllen.

2 x ☑ **Wasp trap**
Hang up in open fields. Fill up with sugared liquids.



Art.	cm	Gr.	Pz./St.	€	EAN
21049			6	7,70-	8 016604 210495



☑ **Insect Trappola adesiva**
Senza veleno e non tossica.

☑ **Insect Trampa adhesiva**
Trampa adhesiva sin veneno y no tóxica.

☑ **Insect Leimring**
Ohne Insektizide.

5 m ☑ **Insect glue bands**
Poison free, non toxic.

Art.	m x cm	Pz./St.	€	EAN
45118	5 m x 5 cm	12	5,80-	8 016604 451188



☑ **Flycontrol Rotolo adesivo**
Trappola adesiva senza veleno e non tossica.

☑ **Flycontrol Rollo adhesivo**
Trampa adhesiva sin veneno y no tóxica.

☑ **Flycontrol Kleberolle**
Ohne Insektizide.

10 m ☑ **Flycontrol sticky roll**
Poison free, non toxic glue trap.

Art.	m x cm	Pz./St.	€	EAN
45122	10 m x 25 cm	12	11,50-	8 016604 451225

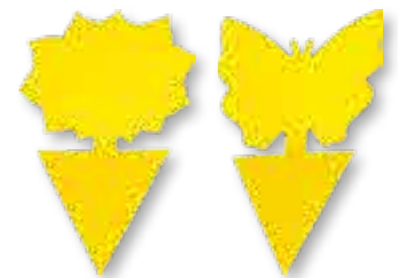

☑ **Insect Adesivo giallo Dekor**
Trappola adesiva senza veleno e non tossica.

☑ **Insect Pegatina amarillo Dekor**
Trampa adhesiva sin veneno y no tóxica.

☑ **Insect Gelbsticker Dekor**
Ohne Insektizide.

12 x ☑ **Insect glue trap Dekor**
Poison free, non toxic.

Art.	cm	Gr.	Pz./St.	€	EAN
45121			24	4,30-	8 016604 451218



☑ **Flycontrol Lanterna acchiappamosche**
Senza veleno e non tossica.

☑ **Flycontrol Lanterna atrappamoscas**
Sin veneno y no tóxica.

☑ **Flycontrol Kleberlaterne**
Ohne Insektizide.

2 x ☑ **Flycontrol glue trap lantern**
Poison free, non toxic.

Art.	cm	Gr.	Pz./St.	€	EAN
45117			12	4,80-	8 016604 451171



☑ **Insect Trappola adesiva**
Senza veleno e non tossica.

☑ **Insect Trampa adhesiva**
Sin veneno y no tóxica.

☑ **Insect Gelbtafel**
Ohne Insektizide.

5 x ☑ **Insect glue trap**
Poison free, non toxic.

Art.	cm	Gr.	Pz./St.	€	EAN
45119	24 x 10		48	4,30-	8 016604 451195
45120	24 x 17		12	10,70-	8 016604 451201



☑ **Talpa-stop solare**
Disabitante per talpe e roditori, produce vibrazioni ad intervalli di 30 secondi circa. Per superfici di ca. 500 m². Pannello solare monocristallino. Funziona senza cavo.

☑ **Topo-Stop solar**
Deshabitante para topos y roedores, produce vibraciones con un intervalo de 30 seg aproximadamente. Para superficies de 500 m². Panel solar monocristalino. Funciona sin cable.

☑ **Wühlmaus-Stop**
Erzeugt in Abständen von 30 Sekunden Vibrationen im Erdreich und vertreibt dadurch Wühl- und Feldmäuse sowie Maulwürfe. Für Flächen von ca. 500 m². Kristall-Solarpaneel. Funktioniert ohne Kabel.

☑ **Solar mole-repeller**
Powerful vibrations are sent through the ground in order to prevent moles and field mice from nesting in the garden area. It is a flat 500 m² crystal solar panel.



Art.	cm	Gr.	Pz./St.	€	EAN
0700	h 80 cm		12	34,40-	8 016604 007002



stocker

www.stockergarden.com

ACCESSORI GIARDINO

ACCESORIOS PARA JARDÍN
GARTENZUBEHÖR
GARDEN ACCESSOIRES

Art. 21113

229

Nuclor gilet imbottito riscaldabile

Involucro esterno garantisce una protezione ottimale dagli elementi. Imbottitura mantiene il calore all'interno. Fodera interna offre un maggiore confort. Cerniere rovesciate antivento conferiscono una sigillatura ottimale. Vestibilità progettata per favorire tutti i movimenti.

Nuclor chaleco acolchado calefactable

Envoltura exterior garantiza una protección óptima contra los elementos. Acolchado mantiene el calor en el interior. Forro interior ofrece una mayor comodidad. Cremalleras inversas a prueba de viento confieren un sellado óptimo. Corte diseñado para facilitar todos los movimientos.

Nuclor beheizbare Weste gefüttert

Außenhülle sorgt für optimalen Schutz vor Witterungseinflüssen. Wattierung hält die Wärme am Körper. Weiches Innenfutter für mehr Tragekomfort. Winddichte Reißverschlüsse sorgen für einen optimalen Schutz. Ideale Passform ermöglicht eine uneingeschränkte Bewegungsfreiheit.

Nuclor heatable padded vest

Outer casing ensures optimum protection from the elements. Padding keeps the heat inside. Inner lining offers greater comfort. Reverse windproof zippers provide optimal sealing. Wearability designed to facilitate all movements.



Art.	mis./Gr.	Pz./St.	€	EAN
1662	S	2	109,50-	8 016604 016622
1663	M	2	109,50-	8 016604 016639
1664	L	2	109,50-	8 016604 016646
1665	XL	2	109,50-	8 016604 016653

Nuclor gilet softshell riscaldabile

Involucro esterno garantisce una protezione ottimale dagli elementi. Fodera interna offre un maggiore confort. Cerniere rovesciate antivento conferiscono una sigillatura ottimale. Vestibilità progettata per favorire tutti i movimenti.

Nuclor chaleco softshell calefactable

Envoltura exterior garantiza una protección óptima contra los elementos. Forro interior ofrece una mayor comodidad. Cremalleras inversas a prueba de viento confieren un sellado óptimo. Corte diseñado para facilitar todos los movimientos.

Nuclor beheizbare Weste softshell

Außenhülle sorgt für optimalen Schutz vor Witterungseinflüssen. Weiches Innenfutter für mehr Tragekomfort. Winddichte Reißverschlüsse sorgen für einen optimalen Schutz. Ideale Passform ermöglicht eine uneingeschränkte Bewegungsfreiheit.

Nuclor heatable softshell vest

Outer casing ensures optimum protection from the elements. Inner lining offers greater comfort. Reverse windproof zippers provide optimal sealing. Wearability designed to facilitate all movements.



Art.	mis./Gr.	Pz./St.	€	EAN
1668	S	2	107,50-	8 016604 016684
1669	M	2	107,50-	8 016604 016691
1670	L	2	107,50-	8 016604 016707
1671	XL	2	107,50-	8 016604 016714

Nuclor giacca softshell riscaldabile

Involucro esterno garantisce una protezione ottimale dagli elementi. Fodera interna offre un maggiore confort. Cerniere rovesciate antivento conferiscono una sigillatura ottimale. Vestibilità progettata per favorire tutti i movimenti.

Nuclor chaqueta softshell calefactable

Envoltura exterior garantiza una protección óptima contra los elementos. Forro interior ofrece una mayor comodidad. Cremalleras inversas a prueba de viento confieren un sellado óptimo. Corte diseñado para facilitar todos los movimientos.

Nuclor beheizbare Jacke softshell

Außenhülle sorgt für optimalen Schutz vor Witterungseinflüssen. Weiches Innenfutter für mehr Tragekomfort. Winddichte Reißverschlüsse sorgen für einen optimalen Schutz. Ideale Passform ermöglicht eine uneingeschränkte Bewegungsfreiheit.

Nuclor heatable softshell jacket

Outer casing ensures optimum protection from the elements. Inner lining offers greater comfort. Reverse windproof zippers provide optimal sealing. Wearability designed to facilitate all movements.



Art.	mis./Gr.	Pz./St.	€	EAN
1674	S	2	122,50-	8 016604 016745
1675	M	2	122,50-	8 016604 016752
1676	L	2	122,50-	8 016604 016769
1677	XL	2	122,50-	8 016604 016776

Power bank 5V 10.000 mAh

Batteria portatile power bank leggera e performante concepita per la linea Nuclor. Massima durata e prestazione per affrontare più a lungo le giornate fredde.

Power bank 5V 10.000 mAh

Bateria portátil power bank ligera y de alto rendimiento diseñada para la línea Nuclor. Máxima duración y rendimiento para afrontar los días fríos durante más tiempo.

Power bank 5V 10.000 mAh

Leistungsstarke und leichte Powerbank, kompatibel mit der Nuclor Linie. Starke Leistung um auch an kalten Tagen warm zu bleiben.

Power bank 5V 10.000 mAh

Lightweight and performing power bank portable battery designed for the Nuclor line. Maximum durability and performance to face cold days longer even longer.



Art.	cm	Gr.	Pz./St.	€	EAN
1660	9,5x6,4x2,6	222	20	39,60-	8 016604 016608



Espositore barra orizzontale per abbigliamento

Expositor barra horizontal para vestimenta

Horizontale Stange für Bekleidung

Display horizontal bar for clothing

vedi pag. 262
ver página 262
siehe Seite 262
see on page 262

Art.	cm	Gr.	Pz./St.	€	EAN
82					8 016604 900822

Portabiti Stocker

Perchero Stocker

Stocker Kleideraufhänger

Stocker Garment rack



Art.	cm	Gr.	Pz./St.	€	EAN
80					8 016604 800801



Scaldacollo Magma

Calentador de cuello Magma

Schal Multifunktionstuch Magma

Neck warmer Magma

Art.	mis./Gr.	Pz./St.	€	EAN
1623		12	9,00-	8 016604 016233



▶ Play video



Occhiale protettivo Matador

Trattamento lenti: antigraffio, antiappannante, antistatico. Inclinazione delle lenti regolabile individualmente.

Gafas de protección Matador

Tratamiento de lentes: antiarañazos, antivaho, antiestático. Ángulo de lente ajustable individualmente.

Matador Schutzbrille

Gläserbehandlung: kratzfest, beschlagfrei und antistatisch. Bügelneigung individuell einstellbar.

Matador protective goggles

Lens treatment: anti-scratch, anti-fog, antistatic. Individually adjustable lens inclination.



Art.	Pz./St.	€	EAN
24116	10	14,65-	8 016604 241161



Occhiale da sole protettivo Voltor

Trattamento lenti: antigraffio. Il profilo superiore in gomma protegge contro la penetrazione di corpi estranei dall'alto.

Gafas de sol protectoras Voltor

Tratamiento de la lente: resistente a los arañazos. El perfil de goma superior protege contra la penetración de cuerpos extraños desde arriba.

Voltor Sonnenbrille - Schutzbrille

Robuste und kratz feste Gläser. Maximaler Schutz durch Gummiprofil an Brillenoberkante.

Voltor protective sunglasses

Lens treatment: anti-scratch. The upper edge of the frame increases safety by preventing the ingress of foreign bodies from above.



Art.	Pz./St.	€	EAN
24117	10	16,15-	8 016604 241178



Copri occhiale protettivo Ontor

Trattamento lenti: antigraffio, antiappannante, antistatico. Lunghezza e inclinazione stanghette regolabile individualmente.

Antiparras de protección ocular Ontor

Tratamiento de lentes: antiarañazos, antivaho, antiestático. Longitud y ángulo de las patillas ajustables individualmente.

Ontor Überbrille - Schutzbrille

Gläserbehandlung: kratzfest, beschlagfrei und antistatisch. Bügelneigung und Bügellänge individuell einstellbar.

Ontor protective eyewear cover

Lens treatment: anti-scratch, anti-fog, antistatic. Individual adjustable temple length and lens inclination.



Art.	Pz./St.	€	EAN
24118	10	17,85-	8 016604 241185

Cuffia antirumore

Ideale per proteggerti dai rumori forti durante le operazioni in campo: SNR 26 dB. Attutisce i rumori di attrezzi e macchinari, più sicurezza per il tuo udito. Morbidi cuscinetti imbottiti per un maggiore comfort, ampio spazio all'interno delle coppe. Archetto regolabile per adattarsi ad ogni misura. Estremamente leggera, permette di indossarle per periodi lunghi, solo 165 gr.

Protector auditivo

Ideal para protegerte de ruidos fuertes durante las operaciones en campo: SNR 26 dB. Amortigua los ruidos de herramientas y maquinarias, más seguridad para tu oído. Suaves almohadillas acolchadas para mayor comodidad, amplio espacio en el interior de las copas. Arco ajustable para adaptarse a cualquier talla. Extremadamente ligero, permite usarlo por largos periodos, solo 165 gr.

Gehörschutz

Ideal zum Schutz vor lauten Geräuschen während der Arbeit in Haus Hof und Garten: SNR 26 dB. Dämpft die Geräusche von Werkzeugen und Maschinen, mehr Sicherheit für Ihr Gehör. Weich gepolsterte Pads für mehr Komfort, viel Platz für die Ohrmuschel. Verstellbarer Kopfbügel zur Anpassung an jede Größe. Extrem leicht, komfortabel bei langem Tragen, nur 165 g.

Hearing protector

Ideal for protecting you from loud noises during your activities: SNR 26 dB. Muffles the noises of tools and machinery, more safety for your hearing. Soft padded pads for greater comfort, wide space inside the cups. Adjustable headband easy to adapt to any size. Extremely light, it allows you to wear it for long periods, only 165 gr.



Art.	Gr.	Pz./St.	€	EAN
24115	165	12	23,95-	8 016604 241154



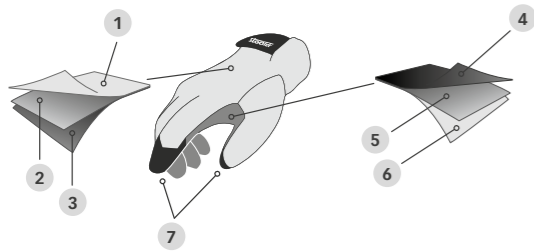

- 1 Tessuto idrorepellente
 Tejido hidropelente
 Wasserabweisender Stoff
 Water repellent fabric
- 2 Doppio strato di fibra di aramide antitaglio
 Doble capa anticorte de fibra de aramida
 Doppelte, schnittfeste Aramid-Faser Schicht
 Double anti cut aramid fibre layer
- 3 Thinsulate C40
- 4 Doppio strato di fibra di aramide antitaglio
 Doble capa anticorte de fibra de aramida
 Doppelte, schnittfeste Aramid-Faser Schicht
 Double anti cut aramid fibre layer
- 5 Pelle di mucca
 Cuero de vaca
 Kuhleder
 Cow leather
- 6 Materiale touchscreen
 Material touchscreen
 Touchscreen-Material
 Touchscreen material
- 7 Materiale touchscreen
 Material touchscreen
 Touchscreen-Material
 Touchscreen material



Guanti invernali antitaglio per motosega
Elevata protezione grazie al doppio strato antitaglio in fibra di aramide. DPI Cat. 1. Mani asciutte e calde grazie al tessuto idrorepellente e imbottito con Thinsulate.

Guantes invernales anticorte para motosierra
Elevada protección gracias a la doble capa anticorte de fibra de aramida. EPI Cat. 1. Manos secas y calidas gracias al tejido repelente al agua y acolchado con Thinsulate.

Schnittfeste Winterhandschuhe Handshuhe für Motorsäge
Hoher Schutz dank doppelter, schnittfester Aramid-Faser Schicht. PSA Kat. 1. Trockene und warme Hände dank wasserabweisendem Material und Thinsulate-Fütterung.

Anti-cut winter gloves for chainsaw
High protection due to the double anti-cut aramid fiber layer. PPE Cat. 1. Dry hands thanks to the water-repellent fabric and warm thanks to the Thinsulate lining.



Art.	mis./Gr.	col./Farbe	Pz./St.	€	EAN
23112	9 / M	■	6	38,30-	8 016604 231124
23113	10 / L	■	6	38,30-	8 016604 231131
23114	11 / XL	■	6	38,30-	8 016604 231148
23115	12 / XXL	■	6	38,30-	8 016604 231155

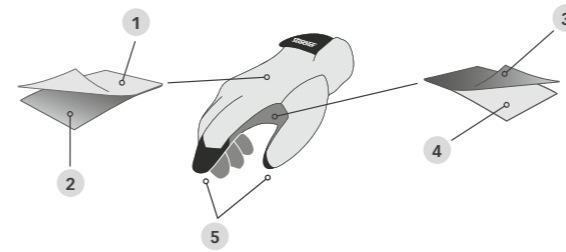

- 1 Tessuto idrorepellente
 Tejido hidropelente
 Wasserabweisender Stoff
 Water repellent fabric
- 2 Doppio strato di fibra di aramide antitaglio
 Doble capa anticorte de fibra de aramida
 Doppelte, schnittfeste Aramid-Faser Schicht
 Double anti cut aramid fibre layer
- 3 Doppio strato di fibra di aramide antitaglio
 Doble capa anticorte de fibra de aramida
 Doppelte, schnittfeste Aramid-Faser Schicht
 Double anti cut aramid fibre layer
- 4 Pelle di mucca
 Cuero de vaca
 Kuhleder
 Cow leather
- 5 Materiale touchscreen
 Material touchscreen
 Touchscreen-Material
 Touchscreen material



Guanti antitaglio per motosega
Elevata protezione grazie al doppio strato antitaglio in fibra di aramide. DPI Cat. 1. Inserti di gomma sul dorso garantiscono l'assorbimento degli urti.

Guantes anticorte para motosierra
Elevada protección gracias a la doble capa anticorte de fibra de aramida. EPI Cat. 1. Las inserciones de goma en el dorso garantizan la absorción de impacto.

Schnittfeste Handshuhe für Motorsäge
Hoher Schutz dank doppelter, schnittfester Aramid-Faser Schicht. PSA Kat. 1. Kunststoffeinsätze am Handrücken garantieren erhöhten Stoßschutz.

Anti-cut gloves for chainsaw
High protection due to the double anti-cut aramid fiber layer. PPE Cat. 1. Rubber pads on the back guarantee high shock absorption.



Art.	mis./Gr.	col./Farbe	Pz./St.	€	EAN
24112	9 / M	■	6	35,00-	8 016604 241123
24113	10 / L	■	6	35,00-	8 016604 241130
24114	11 / XL	■	6	35,00-	8 016604 241147
24119	12 / XXL	■	6	35,00-	8 016604 241192

Requisiti generali
Requisitos generales
Allgemeine Anforderungen
General Requirements

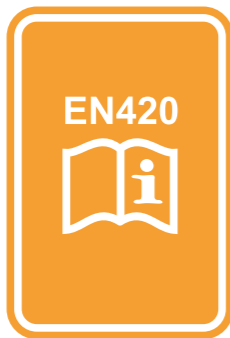

- Definisce le procedure di prova e i requisiti generali per la progettazione e l'imballaggio, la resistenza alla penetrazione dell'acqua, l'innocuità, il comfort, ecc.
- Define los procedimientos de prueba y los requisitos generales para el diseño y el embalaje, la resistencia a la penetración de agua, la seguridad, la comodidad, etc.
- Definiert die Prüfverfahren und die allgemeinen Anforderungen zu Gestaltungsgrundsätzen, Konfektionierung, Widerstand gegen Wasserdurchdringung, Komfort, usw.
- It defines the test procedures and the general requirements regarding the principles of design and packaging, resistance against water penetration, safety, correct marking, etc.

- Indica la categoria assegnata al prodotto a seguito delle prove effettuate. I guanti di categoria III sono la scelta di guanti più adeguata per usi professionali o industriali.
- Especifica la categoría asignada al producto tras las pruebas realizadas. Los guantes de categoría III son la selección más adecuada de guantes para usos profesionales o industriales.
- Verweist auf die Kategorie welche dem Handschuh nach Qualitätsprüfungen zugewiesen wird. Die Handschuhe der Kategorie III sind die bevorzugte Wahl für professionelle und industrielle Anwendungen.
- It indicates the category assigned to the product following the tests carried out. Category III gloves are the most suitable choice for professional or industrial uses.

Rischi meccanici
Riesgos mecánicos
Mechanische Risiken
Mechanical hazards



Livelli di prestazione
Niveles de rendimiento
Leistungsstufen
Performance Levels

- Resistenza al taglio conforme ISO 13997
Resistencia al corte según ISO 13997
Schnittresistent nach Norm ISO 13997
Cut resistance in accordance with ISO 13997
- Resistenza alla perforazione
Resistencia a la perforación
Durchstichfestigkeit
Puncture resistance
- Resistenza allo strappo
Resistencia a la tracción
Reißfestigkeit
Tear resistance
- Resistenza al taglio da lama
Resistencia al corte de la hoja
Schnittfestigkeit
Blade cut resistance
- Resistenza all'abrasione
Resistencia a la abrasión
Abriebfestigkeit
Abrasion resistance

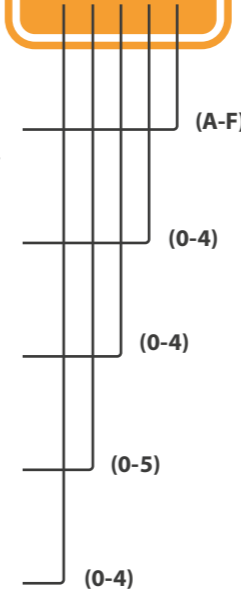

Rischi da taglio
Riesgos de corte
Schnittgefahr
Risks from cutting

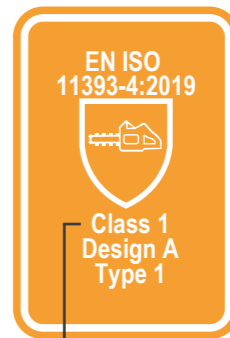

Classi di protezione da taglio
Clases de protección contra los cortes
Schnittschutzklassen
Cut protection classes

- Class 0**
16 m/s velocità della catena
16 m/s velocidad de la cadena
16 m/s Kettengeschwindigkeit
16 m/s chain speed
- Class 1**
20 m/s velocità della catena
20 m/s velocidad de la cadena
20 m/s Kettengeschwindigkeit
20 m/s chain speed
- Class 2**
24 m/s velocità della catena
24 m/s velocidad de la cadena
24 m/s Kettengeschwindigkeit
24 m/s chain speed
- Class 3**
28 m/s velocità della catena
28 m/s velocidad de la cadena
28 m/s Kettengeschwindigkeit
28 m/s chain speed

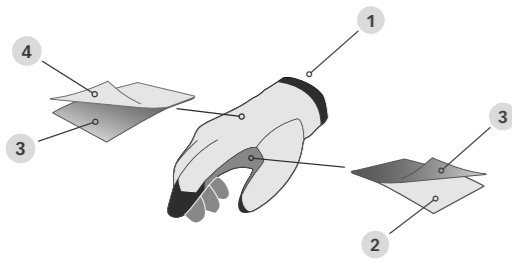

- 1 Elastan
 Elastano
 Elasthan
 Spandex
- 2 Pelle di maiale di alta qualità
 Cuero de cerdo de alta calidad
 Premium Schweinsleder
 Premium Pigskin
- 3 Fibra di aramide antitaglio
 Fibra de aramida anticorte
 Schnitffeste Aramid-Faser
 Anti cut aramid fibre
- 4 Tessuto idrorepellente
 Tejido hidorepelente
 Wasserabweisender Stoff
 Water repellent fabric



Guanti antitaglio
Proteggono le mani contro i tagli mantenendo la sensibilità su palmo e dita.

Guantes anticorte
Protege las manos contra los cortes manteniendo la sensibilidad.

Schnitffeste Handschuhe
Bieten Schutz vor Schnittverletzungen und sorgen für hohe Fingerfertigkeit.

Anti-cut gloves
Protection against cuts whilst maintaining excellent dexterity.



Art.	mis./Gr.	col./Farbe	Pz./St.	€	EAN
24011	8 / S	■	6	19,00-	8 016604 240119
24012	9 / M	■	6	19,00-	8 016604 240126
24013	10 / L	■	6	19,00-	8 016604 240133
24014	11 / XL	■	6	19,00-	8 016604 240140

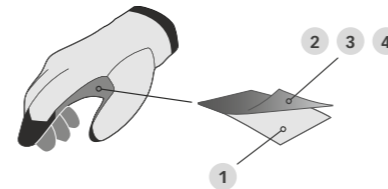

- 1 Rivestimento in PU per touchscreen
 Revestimiento en PU para touchscreen
 PU-Beschichtung für Touchscreen
 Touchscreen PU Coating
- 2 Polietilene ad alta densità
 Polietileno de alta densidad
 Polyethylen hohe Dichte
 High-density polyethylene
- 3 Fibra di vetro antitaglio
 Fibra de vidrio anticorte
 Schnitffeste Glasfaser
 Anti cut glass fibre
- 4 Poliestere
 Poliéster
 Polyester
 Polyester



Guanti antitaglio
Proteggono le mani contro i tagli mantenendo la sensibilità su palmo e dita. Presa antiscivolo sicura.

Guantes anticorte
Protegen las manos contra los cortes manteniendo la sensibilidad. Toma antideslizante segura.

Schnitffeste Handschuhe
Bieten Schutz vor Schnittverletzungen und hohe Fingerfertigkeit. Rutschfester Grip dank Handfläche aus PU.

Anti-cut gloves
Protection against cuts whilst maintaining excellent dexterity. Anti-slip grip due to PU palm.



Art.	mis./Gr.	col./Farbe	Pz./St.	€	EAN
24021	8 / S	■	6	7,70-	8 016604 240218
24022	9 / M	■	6	7,70-	8 016604 240225
24023	10 / L	■	6	7,70-	8 016604 240232
24024	11 / XL	■	6	7,70-	8 016604 240249

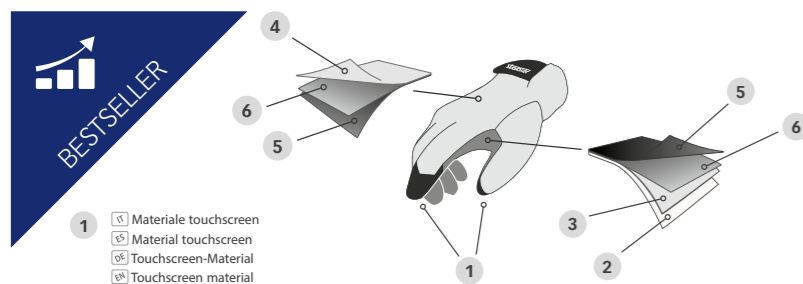

- 1 Materiale touchscreen
 Material touchscreen
 Touchscreen-Material
 Touchscreen material
- 2 Pelle di maiale di alta qualità
 Cuero de cerdo de alta calidad
 Premium Schweinsleder
 Premium Pigskin
- 3 Fibra di aramide antitaglio
 Fibra de aramida anticorte
 Schnitffeste Aramid-Faser
 Anti cut aramid fibre
- 4 Velluto idrorepellente
 Terciopelo hidorepelente
 Wasserabweisender Samt
 Water repellent velvet fabric
- 5 Tessuto Terital Rayon
 Tejido tergal rayón
 Terylene Rayon
 Terylene Rayon Fabric
- 6 Thinsulate C40



Guanti invernali antitaglio
Palmo protetto contro tagli e mani calde fino a -5° C grazie ad imbottitura Thinsulate. È possibile usare lo smartphone senza il fastidio di togliere i guanti.

Guantes invernales anticorte
Palmo protegido contra los cortes y manos calientes hasta -5° C gracias al relleno Thinsulate. Es posible utilizar el smartphone sin el fastidio de quitarse los guantes.

Schnitffeste Winterhandschuhe
Schutz vor Schnittverletzungen auf der Handfläche und warme Hände bis -5° C dank Thinsulate Fütterung. Smartphone und Tablets können ganz einfach bedient werden.

Winter gloves anti-cut
Prevent injuries and maintain a high sense of touch. Hands remain warm up to -5° C thanks to Thinsulate lining. Touchscreen-friendly fingers allow to work with smartphone and tablets.



Art.	mis./Gr.	col./Farbe	Pz./St.	€	EAN
23011	8 / S	■	6	18,25-	8 016604 230110
23012	9 / M	■	6	18,25-	8 016604 230127
23013	10 / L	■	6	18,25-	8 016604 230134
23014	11 / XL	■	6	18,25-	8 016604 230141

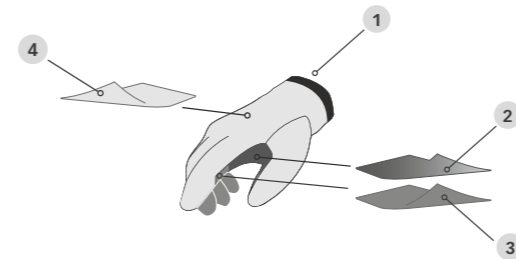

- 1 Polsino elastico
 Puño elástico
 Elastisches Bündchen
 Elastic wristband
- 2 Rinforzo in nitrile liscio
 Refuerzo de nitrilo liso
 Glatte Nitrilverstärkung
 Smooth nitrile reinforcement
- 3 Palma rivestito in nitrile sabbioso
 Palma recubierta de nitrilo arenoso
 Handfläche aus sandigem Nitril
 Sandy nitrile-coated palm
- 4 Inserti in gomma
 Inserciones de goma
 Kunststoffschutz
 Rubber pads



Guanti antitaglio per forbici
Proteggono le mani contro i tagli. Presa salda grazie al palmo rivestito in nitrile sabbioso. Inserti di gomma sul dorso garantiscono l'assorbimento degli urti.

Guantes anticorte para tijeras
Protegen las manos contra los cortes. Agarre firme gracias a la palma recubierta de nitrilo arenoso. Inserciones de goma en el dorso garantizan la absorción de los impactos.

Schnitffeste Handschuhe für Scheren
Bieten Schutz vor Schnittverletzungen. Fester Griff dank sandiger nitrilbeschichteter Handflächen. Kunststoffeinsätze am Handrücken garantieren erhöhten Stoßschutz.

Anti-cut gloves for shears
Protection against cuts. Firm grip thanks to sandy nitrile-coated palm. Rubber pads on the back guarantee high shock absorption.



Art.	mis./Gr.	col./Farbe	Pz./St.	€	EAN
21111	8 / S	■	6	18,40-	8 016604 211119
21112	9 / M	■	6	18,40-	8 016604 211126
21113	10 / L	■	6	18,40-	8 016604 211133
21114	11 / XL	■	6	18,40-	8 016604 211140

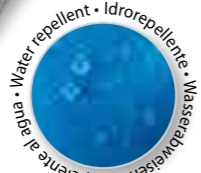

Guanti da giardino
Idrorepellenti e ottima vestibilità.
Presca perfetta grazie al palmo della mano in PU.

Guantes de jardín
Repelente al agua y excelente portabilidad.
Agarre perfecto gracias al palmo de la mano en PU.

Gartenhandschuhe
Wasserabweisend und hoher Tragekomfort.
PU-Handfläche sorgt für einen optimalen Grip.

Garden gloves
Comfortable and water repellent. PU palm provides a perfect grip.



Art.	mis./Gr.	col./Farbe	Pz./St.	€	EAN
23032	9 / M	■	6	7,25-	8 016604230325
23033	10 / L	■	6	7,25-	8 016604230332
23034	11 / XL	■	6	7,25-	8 016604230349



Guanti da giardino Touch
Polso regolabile in velcro.

Guantes de jardín Touch
Pulso de velcro ajustable.

Gartenhandschuhe Touch
Handgelenksabschluss regulierbar mit Klettverschluss.

Garden gloves Touch
Adjustable Velcro wrist closure.



Art.	mis./Gr.	col./Farbe	Pz./St.	€	EAN
24030	7 / XS	■	6	9,00-	8 016604240300
24031	8 / S	■	6	9,00-	8 016604240317
24032	9 / M	■	6	9,00-	8 016604240324
24033	10 / L	■	6	9,00-	8 016604240331
24034	11 / XL	■	6	9,00-	8 016604240348



Guanti da giardino
Il palmo della mano in vera pelle assicura una presa perfetta. Idrorepellenti e dall'ottima vestibilità.

Guantes de jardín
Agarre perfecto gracias al palmo de la mano en cuero.
Repelente al agua y excelente portabilidad.

Gartenhandschuhe
Handfläche aus echtem Leder sorgt für perfekten Halt.
Wasserabweisend und hoher Tragekomfort.

Garden gloves
Real leather palm provides a perfect grip. Comfortable and water repellent.



Art.	mis./Gr.	col./Farbe	Pz./St.	€	EAN
21030	7 / XS	■	6	11,95-	8 016604210303
21031	8 / S	■	6	11,95-	8 016604210310
21032	9 / M	■	6	11,95-	8 016604210327
21033	10 / L	■	6	11,95-	8 016604210334
21034	11 / XL	■	6	11,95-	8 016604210341



Guanti da giardino
I pallini in PVC sul palmo forniscono una presa sicura antiscivolo.

Guantes para jardín
Los puntos de PVC en el palmo hacen sí que el agarre sea seguro y antideslizante.

Gartenhandschuhe
PVC-Noppen auf der Handinnenfläche bieten einen sicheren und rutschfesten Griff.

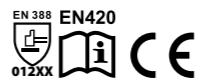

Art.	mis./Gr.	col./Farbe	Pz./St.	€	EAN
22053	7 / XS	■	12	2,35-	8 016604220531
22054	8 / S	■	12	2,35-	8 016604220548
22055	9 / M	■	12	2,35-	8 016604220555

Garden gloves
PVC dots on palm provide a non-slip grip.



Guanti da giardino impermeabili
Grazie al rivestimento impermeabile, è possibile fare lavori su superfici bagnate o negli stagni.

Guantes de jardín impermeables
Gracias al revestimiento impermeable, es posible trabajar en superficies húmedas o en los estanques.

Wasserdichte Gartenhandschuhe
Dank der wasserdichten Beschichtung können problemlos Arbeiten auf nassen Untergründen oder am Teich verrichtet werden.



Art.	mis./Gr.	col./Farbe	Pz./St.	€	EAN
22120	7 / XS	■	6	5,70-	8 016604221200
22121	8 / S	■	6	5,70-	8 016604221217
22122	9 / M	■	6	5,70-	8 016604221224
22123	10 / L	■	6	5,70-	8 016604221231
22124	11 / XL	■	6	5,70-	8 016604221248

Waterproof garden gloves
Thanks to the waterproof coating, you can easily work on wet surfaces or on the pond.

Guanti ultra fini da lavoro
Presca salda grazie al palmo rivestito in schiuma di nitrile. Ottima sensibilità e vestibilità, con funzione touch.

Guantes de trabajo ultra finos
Agarre firme gracias a la palma recubierta de espuma de nitrilo. Excelente sensibilidad y ajuste, con función táctil.

Ultradünne Arbeitshandschuhe
Fester Griff durch Handflächen in Nitrilschaum. Ausgezeichnete Passform und Feingefühl, Fingerspitzen mit Touch-Funktion.

Ultra-fine working gloves
Firm grip thanks to nitrile foam-coated palm. Excellent sensitivity and fit, with touch function.



Art.	mis./Gr.	col./Farbe	Pz./St.	€	EAN
21121	8 / S	■	12	4,40-	8 016604211218
21122	9 / M	■	12	4,40-	8 016604211225
21123	10 / L	■	12	4,40-	8 016604211232
21124	11 / XL	■	12	4,40-	8 016604211249



Guanti in fibra di bambù
Il tessuto in fibra di bambù mantiene la temperatura corporea ad un giusto livello ed è in grado di assorbire il sudore. Ecologici. Con rivestimento antiscivolo.

Guantes de fibra de bambú
El tejido de fibra de bambú conserva la temperatura corporal a un nivel adecuado y es capaz de absorber el sudor. Ecológicos. Con revestimiento antideslizante.

Handschuhe aus Bambusfaser
Die Bambusfaser wirkt feuchtigkeitsregulierend und sorgt für reduziertes Schwitzen. Umweltschonend. Mit Anti-Rutsch-Beschichtung für einen perfekten Halt.



Art.	mis./Gr.	col./Farbe	Pz./St.	€	EAN
21020	7 / XS	■	12	4,00-	8 016604210204
21021	8 / S	■	12	4,00-	8 016604210211
21022	9 / M	■	12	4,00-	8 016604210228
21023	10 / L	■	12	4,00-	8 016604210235
21024	11 / XL	■	12	4,00-	8 016604210242

Bamboo fibre gloves
The bamboo fiber regulates the body temperature and reduces sweating. Ecological. Anti-slip coated gloves.



Guanti in fibra di bambù
Il tessuto in fibra di bambù assorbe ed elimina rapidamente l'umidità della pelle. I pallini sul palmo forniscono una presa sicura antiscivolo.

Guantes en fibra de bambú
El tejido en fibra de bambú absorbe y elimina rápidamente la humedad de la piel. Los puntos en el palmo hacen sí que el agarre sea seguro y antideslizante.

Handschuhe aus Bambusfaser
Die Bambusfaser wirkt atmungsaktiv und absorbiert Feuchtigkeit schnell. Die Noppen auf der Handinnenfläche bieten einen sicheren und rutschfesten Griff.



Art.	mis./Gr.	col./Farbe	Pz./St.	€	EAN
22031	8 / S	■	6	5,45-	8 016604220319
22032	9 / M	■	6	5,45-	8 016604220326
22033	10 / L	■	6	5,45-	8 016604220333
22034	11 / XL	■	6	5,45-	8 016604220340

Bamboo fibre gloves
The bamboo fabric absorbs perspiration away from the body. The dots on the palm of the hand provide a secure and non-slip grip.



Guanti da giardino
Palmo in pelle sintetica.

Guantes para jardín
Palmo en piel sintética.

Gartenhandschuhe
Handfläche aus Kunstleder.

Garden gloves
Synthetic leather palm.

Art.	mis./Gr.	col./Farbe	Pz./St.	€	EAN
23050	7 / XS	■	6	7,05-	8 016604 230509
23051	8 / S	■	6	7,05-	8 016604 230516
23052	9 / M	■	6	7,05-	8 016604 230523

Guanti da giardino
Palmo in pelle sintetica.

Guantes para jardín
Palmo en piel sintética.

Gartenhandschuhe
Handfläche aus Kunstleder.

Garden gloves
Synthetic leather palm.

Art.	mis./Gr.	col./Farbe	Pz./St.	€	EAN
23053	7 / XS	■	6	7,05-	8 016604 230530
23054	8 / S	■	6	7,05-	8 016604 230547
23055	9 / M	■	6	7,05-	8 016604 230554

Guanti da giardino
100% in poliestere, con palmo spalmato in nitrile.
Traspiranti, con una presa perfetta.

Guantes de jardín
100% poliéster, con el palmo recubierto de nitrilo.
Transpirable, con un agarre perfecto.

Gartenhandschuhe
100% Polyester mit Nitril-beschichteter Handfläche.
Atmungsaktiv und hohe Griffigkeit.

EN 388 EN 420
3121X

Garden gloves
100% polyester with nitrile coated palm. Good breathability and perfect grip.

Art.	mis./Gr.	col./Farbe	Pz./St.	€	EAN
23020	7 / XS	■	12	2,75-	8 016604 230202
23021	8 / S	■	12	2,75-	8 016604 230219
23022	9 / M	■	12	2,75-	8 016604 230226

Guanti da giardino
Palmo in pelle sintetica.

Guantes para jardín
Palmo en piel sintética.

Gartenhandschuhe
Handfläche aus Kunstleder.

Garden gloves
Synthetic leather palm.

Art.	mis./Gr.	col./Farbe	Pz./St.	€	EAN
23090	8 / S	■	12	12,05-	8 016604 230905
23091	9 / M	■	12	12,05-	8 016604 230912
23092	10 / L	■	12	12,05-	8 016604 230929
23093	11 / XL	■	12	12,05-	8 016604 230936



Guanti per rose
Protezione delle mani contro le punture delle spine.
Presa anti-scivolo sicura.

Guantes para rosas
Protección de las manos contra las picaduras de espinas.
Toma antideslizante segura.

Rosenhandschuhe
Schutz der Hände vor Stacheln und Dornen. Rutschfester Grip.

Rose gloves
Protect your hands from thorn punctures.
Anti-slip grip.

Art.	mis./Gr.	col./Farbe	Pz./St.	€	EAN
22090	7 / XS	■	6	5,20-	8 016604 220906
22091	8 / S	■	6	5,20-	8 016604 220913
22092	9 / M	■	6	5,20-	8 016604 220920
22093	10 / L	■	6	5,20-	8 016604 220937
22094	11 / XL	■	6	5,20-	8 016604 220944

Guanti per rose
Protezione delle mani contro le punture delle spine.
Presa anti-scivolo sicura.

Guantes para rosas
Protección de las manos contra las picaduras de espinas.
Toma antideslizante segura.

Rosenhandschuhe
Schutz der Hände vor Stacheln und Dornen. Rutschfester Grip.

Rose gloves
Protect your hands from thorn punctures.
Anti-slip grip.

Art.	mis./Gr.	col./Farbe	Pz./St.	€	EAN
22110	7 / XS	■	6	5,20-	8 016604 221101
22111	8 / S	■	6	5,20-	8 016604 221118
22112	9 / M	■	6	5,20-	8 016604 221125
22113	10 / L	■	6	5,20-	8 016604 221132
22114	11 / XL	■	6	5,20-	8 016604 221149

Guanti invernali
Con il tessuto idrorepellente le tue mani rimarranno asciutte.
Mani calde fino a -5° C grazie all'imbottitura Thinsulate.
Il palmo in pelle offre il massimo comfort.

Guantes invernales
Con el tejido hidrorrepelente tus manos se quedarán secas.
Manos calientes hasta -5° C gracias al relleno Thinsulate.
El palmo de cuero ofrece máxima comodidad.

Winterhandschuhe
Die Hände bleiben länger trocken dank des wasserabweisenden Materials. Warme Hände bis -5° C dank Thinsulate-Fütterung. Die Handfläche aus Leder sorgt für maximalen Tragekomfort.

Winter gloves
Keep your hands perfectly dry thanks to water-repellent material. The Thinsulate lining and leather palm ensure high wearing comfort and warm hands up to -5° C.

EN 388 EN 420
3121X

Art.	mis./Gr.	col./Farbe	Pz./St.	€	EAN
22130	7 / XS	■	6	10,90-	8 016604 221309
22131	8 / S	■	6	10,90-	8 016604 221316
22132	9 / M	■	6	10,90-	8 016604 221323
22133	10 / L	■	6	10,90-	8 016604 221330
22134	11 / XL	■	6	10,90-	8 016604 221347



Guanti da lavoro invernali
Mani calde fino ad una temperatura di -5° C.

Guantes de trabajo invernales
Manos calientes hasta una temperatura de -5° C.

Winter-Arbeitshandschuhe
Die Hände bleiben auch bei Temperaturen bis zu -5° C warm.

Winter working gloves
Hands remain warm even in temperatures of up to -5° C.

Art.	mis./Gr.	col./Farbe	Pz./St.	€	EAN
22021	8 / S	■	6	5,80-	8 016604 220210
22022	9 / M	■	6	5,80-	8 016604 220227
22023	10 / L	■	6	5,80-	8 016604 220234
22024	11 / XL	■	6	5,80-	8 016604 220241



Guanti invernali
Con polsino regolabile in velcro. Buon isolamento contro il freddo. Presa perfetta grazie al palmo della mano in PU.

Guantes invernales
Con pulso de velcro ajustable. Buen aislamiento contra el frío. Agarre perfecto gracias al palmo de la mano en PU.

Winterhandschuhe
Mit Klettverschluss. Ausgezeichnete Kälteisolierung. PU-Handfläche sorgt für einen optimalen Grip.

Winter gloves
With velcro wrist closure. Very good cold protection. PU palm provides a perfect grip.



Art.	mis./Gr.	col./Farbe	Pz./St.	€	EAN
23041	8 / S	■	6	10,80-	8 016604 230417
23042	9 / M	■	6	10,80-	8 016604 230424
23043	10 / L	■	6	10,80-	8 016604 230431
23044	11 / XL	■	6	10,80-	8 016604 230448
23045	12 / XXL	■	6	10,80-	8 016604 230455



Guanti da lavoro
Ideali per lavori in agricoltura. Il guanto in morbida pelle di capra offre maggiore comfort.

Guantes de trabajo
Ideal para la agricultura. El guante de suave piel de cabra ofrece una mayor comodidad.

Arbeitshandschuhe
Ideal für Arbeiten im Garten und der Landwirtschaft. Das weiche Ziegenleder sorgt für maximalen Tragekomfort.

Working gloves
Ideal for agriculture and gardening. The soft goat leather ensures maximum wearing comfort.

Art.	mis./Gr.	col./Farbe	Pz./St.	€	EAN
22141	8 / S	■	6	6,30-	8 016604 221415
22142	9 / M	■	6	6,30-	8 016604 221422
22143	10 / L	■	6	6,30-	8 016604 221439
22144	11 / XL	■	6	6,30-	8 016604 221446



Guanti da lavoro
Ideali per lavori in agricoltura ed edilizia. Molto resistenti grazie al palmo della mano in vera pelle.

Guantes de trabajo
Ideal para la agricultura y la construcción. Agarre perfecto gracias al palmo de la mano en cuero.

Arbeitshandschuhe
Ideal geeignet für Landwirtschaft, Holz- und Baugewerbe. Strapazierfähige Handfläche aus echtem Leder.

Working gloves
Ideal for agriculture and construction industry. Hard-wearing gloves with real leather palm.

Art.	mis./Gr.	col./Farbe	Pz./St.	€	EAN
21074	10 / L	■	6	6,90-	8 016604 210747
21075	11 / XL	■	6	6,90-	8 016604 210754
21076	12 / XXL	■	6	6,90-	8 016604 210761



Guanti da lavoro
Guanti in pelle resistente e poliestere. Il palmo in pelle garantisce una lunga durata nel tempo.

Guantes de trabajo
Guantes de trabajo en poliéster y cuero duradero. El palmo en piel garantiza una mayor durabilidad.

Arbeitshandschuhe
Handschuhe aus resistantem Leder und Polyester. Mit Leder verstärkte Fingerkuppen.

Working gloves
Gloves made of polyester and very resistant leather. Palm and finger pads are reinforced with leather.

Art.	mis./Gr.	col./Farbe	Pz./St.	€	EAN
23073	9 / M	■	6	10,50-	8 016604 230738
23074	10 / L	■	6	10,50-	8 016604 230745
23075	11 / XL	■	6	10,50-	8 016604 230752



Guanti da lavoro
Guanti in pelle resistente e poliestere. Il palmo in pelle garantisce una lunga durata nel tempo.

Guantes de trabajo
Guantes de trabajo en poliéster y cuero duradero. El palmo en piel garantiza una mayor durabilidad.

Arbeitshandschuhe
Handschuhe aus resistantem Leder und Polyester. Mit Leder verstärkte Fingerkuppen.

Working gloves
Gloves made of polyester and very resistant leather. Palm and finger pads are reinforced with leather.

Art.	mis./Gr.	col./Farbe	Pz./St.	€	EAN
23070	9 / M	■	6	10,50-	8 016604 230707
23071	10 / L	■	6	10,50-	8 016604 230714
23072	11 / XL	■	6	10,50-	8 016604 230721



Guanti da lavoro
Palmo in pelle sintetica.

Guantes de trabajo
Palmo en piel sintética.

Arbeitshandschuhe
Handfläche aus Kunstleder.

Working gloves
Synthetic leather palm.

Art.	mis./Gr.	col./Farbe	Pz./St.	€	EAN
23081	9 / M	■	6	5,45-	8 016604 230813
23082	10 / L	■	6	5,45-	8 016604 230820
23084	11 / XL	■	6	5,45-	8 016604 230844



Guanti da lavoro
Palmo in pelle sintetica.

Guantes de trabajo
Palmo en piel sintética.

Arbeitshandschuhe
Handfläche aus Kunstleder.

Working gloves
Synthetic leather palm.

Art.	mis./Gr.	col./Farbe	Pz./St.	€	EAN
23085	9 / M	■	6	5,45-	8 016604 230851
23086	10 / L	■	6	5,45-	8 016604 230868
23087	11 / XL	■	6	5,45-	8 016604 230875



Guanti da lavoro
In blister. Spalmato in nitrile.

Guantes de trabajo
En blister. Recubierto de nitrilo.

Arbeitshandschuhe
Im Blister. Mit Nitrilbeschichtung

EN 388 EN420
3121X Working gloves
In blister. Nitril coating.

Art.	mis./Gr.	col./Farbe	Pz./St.	€	EAN
21053	8	■	12	2,35-	8 016604 210532
21054	9	■	12	2,35-	8 016604 210549
21055	10	■	12	2,35-	8 016604 210556



* fino ad esaurimento
* hasta agotamiento
* solange der Vorrat reicht
* While supplies last



Guanti da lavoro
In blister. Palmo rivestito in lattice.

Guantes de trabajo
En blister. Palmo recubierto de latex.

Arbeitshandschuhe
Im Blister. Handfläche mit Latexbeschichtung.

EN 388 EN420
2143 Working gloves
In blister. Latex coated palm.

Art.	mis./Gr.	col./Farbe	Pz./St.	€	EAN
21056	8	■	12	2,55-	8 016604 210563
21057	9	■	12	2,55-	8 016604 210570
21058	10	■	12	2,55-	8 016604 210587



* fino ad esaurimento
* hasta agotamiento
* solange der Vorrat reicht
* While supplies last



Espositore per guanti girevole
Guanti

Expositor para guantes giratorio
Guantes

Drehbarer Verkaufsstand für Handschuhe
Handschuhe

Display for gloves, revolving
Gloves

Art.	cm	Pz./St.	€	EAN
52				8 016604 000522



Espositore in cartone
Guanti

Expositor de cartón
Guantes

Verkaufsstand aus Karton
Handschuhe

Cardboard display
Gloves

Art.	cm	Pz./St.	€	EAN
43				8 016604 000430

* fino ad esaurimento
* hasta agotamiento
* solange der Vorrat reicht
* While supplies last



Guanti da lavoro
In blister. Palmo rivestito in PU.

Guantes de trabajo
En blister. Palmo recubierto de PU.

Arbeitshandschuhe
Im Blister. Handfläche mit PU-Beschichtung.

EN 388 EN420
4141X Working gloves
In blister. PU coated palm.

Art.	mis./Gr.	col./Farbe	Pz./St.	€	EAN
21050	8	■	12	2,55-	8 016604 210501
21051	9	■	12	2,55-	8 016604 210518
21052	10	■	12	2,55-	8 016604 210525



Guanti da lavoro
Sfuso.

Guantes de trabajo
Granel.

Arbeitshandschuhe
Lose.

Working gloves
Loose.

Art.	mis./Gr.	col./Farbe	Pz./St.	€	EAN
22050	8	■	12	2,05-	8 016604 220500
22051	9	■	12	2,05-	8 016604 220517
22052	10	■	12	2,05-	8 016604 220524



Guanti da giardino KIDS GARDEN
Con polsino regolabile.
In materiale di alta qualità.

Guantes de jardín KIDS GARDEN
Con velcro regulable.
Con material de alta calidad.

Gartenhandschuhe KIDS GARDEN
Mit Klettverschluss. Erstklassige Qualität.

Garden gloves KIDS GARDEN
With velcro fastening. First-class material.

Art.	cm	col./Farbe	Pz./St.	€	EAN
22068		■	6	5,80-	8 016604 220685
22069		■	6	5,80-	8 016604 220692

EN420
Working gloves



Guanti da lavoro
In blister. Palmo rivestito in PU.

Guantes de trabajo
En blister. Palmo recubierto de PU.

Arbeitshandschuhe
Im Blister. Handfläche mit PU-Beschichtung.

EN 388 EN420
4131X Working gloves
In blister. PU coated palm.

Art.	mis./Gr.	col./Farbe	Pz./St.	€	EAN
21060	8	■	12	2,55-	8 016604 210600
21061	9	■	12	2,55-	8 016604 210617
21062	10	■	12	2,55-	8 016604 210624



Guanti da lavoro
Sfuso.

Guantes de trabajo
Granel.

Arbeitshandschuhe
Lose.

Working gloves
Loose.

Art.	mis./Gr.	col./Farbe	Pz./St.	€	EAN
22060	8	■	12	2,05-	8 016604 220609
22061	9	■	12	2,05-	8 016604 220616
22062	10	■	12	2,05-	8 016604 220623



Guanti da giardino KIDS GARDEN
Guantes de jardín KIDS GARDEN
Gartenhandschuhe KIDS GARDEN
Garden gloves KIDS GARDEN

EN420
Working gloves

Art.	cm	col./Farbe	Pz./St.	€	EAN
22056		■	12	2,75-	8 016604 220562
22057		■	12	2,75-	8 016604 220579
22058		■	12	2,75-	8 016604 220586



- Carrello spandiconcime e spandisale 60 L
- Carro abonador y de sal 60 L
- Dünger- und Salzstreuer 60 L
- Drop and salt spreader 60 L

60 LITER vedi pag. 342
ver página 342
siehe Seite 342
see on page 342



- Carrello spandiconcime e spandisale 40 L
- Carro abonador y de sal 40 L
- Dünger- und Salzstreuer 40 L
- Drop and salt spreader 40 L

40 LITER vedi pag. 341
ver página 341
siehe Seite 341
see on page 341



Art.	lt.	Ø m	Pz./St.	€	EAN
3907	60	5 m	1	171,50-	8 016604 039072

Art.	lt.	Ø m	Pz./St.	€	EAN
3906	40	5 m	1	158,50-	8 016604 039065



- Spandiconcime e Spandisamenti 12 L
- Carro abonador y semillero 12 L
- Streuwagen 12 L
- Drop spreader 12 L

12 LITER * fino ad esaurimento
* hasta agotamiento
* solange der Vorrat reicht
* While supplies last



Art.	lt.	cm	Pz./St.	€	EAN
3916	12	45 cm	2	57,90-	8 016604 039164



- Spandiconcime manuale
Amplezza di distribuzione da 1 a 2 mt.

- Abonador manual
Amplitud de distribución de 1 a 2 m.

- Handstreuer
Streubreite von 1 bis 2 m.

- Manual spreader
Distribution width from 1 to 2 m.

1,5 LITER

Art.	lt.	Gr.	Pz./St.	€	EAN
3902	1 - 1,5		12	22,60-	8 016604 039010



- Carrello spandiconcime e spandisale 25 L
- Carro abonador y de sal 25 L
- Streuwagen 25 L
- Drop and salt spreader 25 L

25 LITER vedi pag. 344
ver página 344
siehe Seite 344
see on page 344



- Spandisamenti e spandiconcime
- Carro abonador y semillero
- Kastenstreuer
- Drop spreader

27 KG vedi pag. 345
ver página 345
siehe Seite 345
see on page 345

Art.	kg	cm	Pz./St.	€	EAN
3915	27	56 cm	1	156,50-	8 016604 039157

Art.	lt.	Ø m	Pz./St.	€	EAN
3914	25	5 m	1	122,00-	8 016604 039140



- Contenitore in polietilene
- Contenedor de polietileno
- Tank aus Polyethylene
- Polyethylen flexible tub

* = 2 pz./St. verde/verde/Grün/green
+ 2 pz./St. blu/azul/Blau/blue
+ 2 pz./St. arancio/naranja/Orange/orange

15 LITER * fino ad esaurimento
* hasta agotamiento
* solange der Vorrat reicht
* While supplies last

Art.	misura/Größe	lt	Pz./St.	€	EAN
4910	S	15	6*	7,50-	8 016604 049101



- Raccogli-rifiuti
- Recoge desperdicios
- Unrat-Greifer
- Trash grabber

100 cm

Art.	cm	Gr.	Pz./St.	€	EAN
605	100	290	12	40,00-	8 016604 906053



Sacco giardino
Stabilizzato ai raggi UV in tessuto di polietilene per una lunga durata. 2 maniglie. Lavabile.

Saco jardín
Fabricado en PE, tratamiento anti UV para una larga durabilidad. 2 asas. Lavable.

Gartensack
UV stabilisiertes PE-Gewebe für eine lange Lebensdauer. 2 Tragegriffe. Abwaschbar.



180 LITER
Garden bag
The garden bag is made out of polyethylene fabric, for protection against UV rays. The bag is washable. A long bag life guaranteed.

Art.	cm	lt	Pz./St.	€	EAN
4712	55 x 55 x 75 cm	180	12	10,00-	8 016604 047121



Sacco giardino
Chiusura con cordoncino. In polietilene 200 g/m². Trasporto facile grazie alle 4 maniglie. Lavabile.

Saco jardín
Con cierre de cordón. Tejido en polietilene 200 g/m². Transporte fácil gracias a los 4 mangos. Lavable.

Gartensack
Mit verschließbarer Kordel. Polyethylengewebe 200 g/m². 4 Tragegriffe für einfachen Transport. Abwaschbar.



148 LITER
Garden bag
With drawstring closure. Made from heavy duty polyethylene 200 g/m². Thanks to 4 carrying handles the bag can be easily moved. Washable.

Art.	cm	lt	Pz./St.	€	EAN
4728	Ø 55 x h 70	148	6	17,20-	8 016604 047282



Per garantire un'apertura stabile del sacco, inserire l'anello PE come nella foto.

Para garantizar una abertura estable, introducir el anillo PE como en la foto.

Um eine stabile Öffnung des Sackes zu garantieren, bitte den beigelegten PE-Spannungsring wie im Foto einführen.

To guarantee a stable opening of the bag, please use the enclosed PE tension ring, as demonstrated in the photo.



Sacco giardino
Stabilizzato ai raggi UV in tessuto di polietilene 200 g per una lunga durata. Autoportante con anello di rinforzo. 4 maniglie. Lavabile.

Saco jardín
Fabricado en PE (200gr), tratamiento anti UV para una larga durabilidad. Se mantiene en pie por sí mismo, gracias al anillo metálico que lleva de refuerzo. 4 asas. Lavable.

Gartensack
UV stabilisiertes PE-Gewebe 200 g für eine lange Lebensdauer. Selbststehender Gartensack mit Verstärkungsring. 4 Tragegriffe. Abwaschbar.



150 LITER **270 LITER**
Garden bag
With four handles. Self-standing. The bag is made out of a UV protection polyethylene fabric; for a long bag life.

Art.	cm	lt	Pz./St.	€	EAN
4713	Ø 50 x h 75	150	12	15,20-	8 016604 047138
4714	Ø 66 x h 75	270	6	18,40-	8 016604 047145



Pop Up - Sacco giardino
Rivestimento interno in PVC. Resistente ai raggi UV. Autoportante Pop-Up. 3 maniglie. Lavabile.

Pop Up - Saco de jardín
Revestimiento interior en PVC. Resistencia Ultravioleta. Autoportante Pop-Up. 3 asas. Lavable.

Pop Up - Gartensack
Innenverkleidung aus PVC. UV-beständig. Selbsttragender Pop-Up. 3 Tragegriffe. Waschbar.



137 LITER **98 LITER**
Pop Up garden bag
Interior lining made of PVC. UV-resistant. Self supporting Pop-Up. 3 handles. Washable.

Art.	cm	lt	Pz./St.	€	EAN
4716	Ø 50 x h 70	137	6	26,30-	8 016604 047169
4717	Ø 47 x h 57	98	6	24,50-	8 016604 047176



Pop Up - Sacco giardino
Tessuto di polietilene. Resistente ai raggi UV. Autoportante Pop-Up. 3 maniglie. Lavabile. Peso: 110 gr.

Pop Up - Saco de jardín
Tela de polietilene. Resistencia Ultravioleta. Autoportante Pop-Up. 3 asas. Lavable. Peso: 110 gr.

Pop Up - Gartensack
Material aus Polyethylen. UV-beständig. Selbsttragender Pop-Up. 3 Tragegriffe. Waschbar. Gewicht: 110 g.



137 LITER **98 LITER**
Pop Up garden bag
Made of polyethylene. UV-resistant. Self supporting Pop-Up. 3 handles. Washable. Weight: 110 gr.

Art.	cm	lt	Pz./St.	€	EAN
4718	Ø 50 x h 70	137	6	18,00-	8 016604 047183
4719	Ø 47 x h 57	98	6	14,20-	8 016604 047190



Termoquick
• Colore: verde.
• Materiale 100% plastica riciclata.
• Materiale molto resistente da tenere all'aperto.
• Facile da montare - tutti elementi singoli.
• Per i rifiuti naturali del giardino e della cucina.
• Le pareti laterali isolanti consentono un veloce compostaggio.
• Semplice da svuotare.

Termoquick
• Color: verde.
• Material 100% plástico reciclado.
• Material muy resistente, preparado para la intemperie.
• De fácil montaje.
• Para el desperdicio orgánico del jardín y de la cocina.
• Las paredes laterales permiten por su aislamiento un compostaje más rápido.
• Simple de vaciar.

Termoquick
• Farbe: Grün.
• ökologisch wertvoll
• schnelle Kompostierung durch optimale Belüftung
• dicke, wärmespeichernde Wände
• großes Kompostvolumen
• bequeme Kompostentnahme

Termoquick
• Colour: Green.
• 100% recycled plastic
• ideal also for the outside
• easy to assemble
• for garden and kitchen waste
• well isolated for a quick compost
• easy to empty

Art.	cm	lt	Pz./St.	€	EAN
4902	78 x 78 x h 86	410	1	152,00-	4 012007 341075
4905	86 x 86 x h 102	610	1	211,00-	4 012007 168054



Misuratore combi per suolo
3-in-1 Misuratore per suolo:
- Valore indicativo dell'umidità vicino alle radici
- Valore pH del suolo
- Luminosità (all'esterno)
Funziona senza corrente o batterie.

Medidor combi para suelo
3-in-1 medidor para suelo:
- valor indicativo de la humedad alrededor de las raíces
- valor pH del suelo
- luminosidad (al aire libre)
Funciona sin pilas y sin corriente.

Kombi Bodenmessgerät
3-in-1 Messgerät: Anhaltswert für Feuchtigkeit an der Wurzel, pH-Wert der Erde, Standort-Helligkeit (nur für Außenbereich). Strom- und batteriefrei.

Combi soil tester
3-in-1 Soil Tester: humidity value for root-zone, soil pH value, light intensity of position (only for outdoor areas). Battery and current-free.

Art.	cm	Gr.	Pz./St.	€	EAN
9646			6	21,50-	8 016604 096464



Secchiello KIDS GARDEN
In metallo.

Balde KIDS GARDEN
De metal.

Eimer KIDS GARDEN
Aus Metall.

Bucket KIDS GARDEN
Metal.



Set attrezzi e secchiello KIDS GARDEN

Set herramientas y balde KIDS GARDEN

Set Gartenwerkzeug und Eimer KIDS GARDEN

Garden tools and bucket set KIDS GARDEN



Art.	lt.	col./Farbe	Pz./St.	€	EAN
4913	1		6	6,90-	8 016604049132
4915	1		6	6,90-	8 016604049156
4926	1		6	6,90-	8 016604049262

Art.	lt.	col./Farbe	Pz./St.	€	EAN
2326			6	17,10-	8 016604023262
2322			6	17,10-	8 016604023224
2329			6	17,10-	8 016604023293



Pluviometro 50 ml
Ciascuna tacca corrisponde a 1 lt/m². 50 mm.

Pluviómetro 50 ml
Cada muesca corresponde a 1lt/m². 50 mm.

Regenmesser 50 ml
Jeder Teilstrich entspricht 1 l/m² Regen. 50 mm.

50 MM Rain gauge 50 ml
Each line is 1 l/m². 50 mm.

Art.	mm	Gr.	Pz./St.	€	EAN
4523	50		24	7,30-	8 0166040582301



Tutore in fibra di cocco

Tutor de fibra de coco

Kokos-Pflanzstab

Coconut fibre trellis



Art.	Ø cm	cm	Pz./St.	€	EAN
45500	6	60	24	4,70-	8 016604455001
45501	6	90	24	5,20-	8 016604455018
45502	6	120	24	7,00-	8 016604455025



Secchiello KIDS GARDEN
In plastica.

Balde KIDS GARDEN
De plástico.

Eimer KIDS GARDEN
Aus Kunststoff.

Bucket KIDS GARDEN
Plastic.



Carriola KIDS GARDEN
Con vasca in metallo.

Carretilla KIDS GARDEN
Con bandeja de metal.

Schubkarren KIDS GARDEN
Mit Metallwanne.

Wheelbarrow KIDS GARDEN
With a metal tray.



Art.	lt.	col./Farbe	Pz./St.	€	EAN
4927	1		12	6,00-	8 016604049279
4928	1		12	6,00-	8 016604049286

Art.	cm	Pz./St.	€	EAN
2316	75 x 37 x h 40,5 cm	4	37,70-	8 016604023163



Reggipiante

Tutor

Pflanzenstab

Plant support

Art.	Ø mm	cm	Pz./St.	€	EAN
200	8	90	200	1,00-	8 016604002007
201	11	120	100	1,60-	8 016604002014
202	11	150	100	1,80-	8 016604002021
203	16	180	48	3,40-	8 016604002038
204	20	210	36	5,20-	8 016604002045
205	20	240	36	6,10-	8 016604002052



Reggipiante bambù plastificato

Tutor bambù plastificado

Bambus-Pflanzstab plastifiziert

Plasticized bamboo planting sticks

Art.	Ø mm	cm	Pz./St.	€	EAN
4542	6-8	60	100	0,60-	8 016604200465
4543	8-10	90	100	1,00-	8 016604200618
4544	10-12	120	100	1,20-	8 016604200441
4545	14-16	150	100	2,00-	8 016604200380
4549	14-16	180	50	2,80-	8 016604200373
4551	14-16	210	50	3,80-	8 016604200359



Innaffiatoio KIDS GARDEN
In metallo.

Regadera KIDS GARDEN
De metal.

Gießkanne KIDS GARDEN
Aus Metall.

Watering can KIDS GARDEN
Metal.



Innaffiatoio KIDS GARDEN

Regadera KIDS GARDEN

Gießkanne KIDS GARDEN

Watering can KIDS GARDEN



Art.	lt.	col./Farbe	Pz./St.	€	EAN
4914	1		6	12,00-	8 016604049149
4916	1		6	12,00-	8 016604049163
4924	1		6	12,00-	8 016604049248

Art.	lt.	col./Farbe	Pz./St.	€	EAN
4919	0,35		12	5,40-	8 016604049194
4920	0,35		12	5,40-	8 016604049200
4925	0,35		12	5,40-	8 016604049255



Reggipiante in bambù

Tutor de bambú

Bambus-Pflanzstäbe

Bamboo planting sticks

Art.	Ø mm	cm	Pz./St.	€	EAN
4793	22-24	150	50	1,70-	8 016604047930
4794	22-24	180	50	1,70-	8 016604047947
4795	22-24	210	50	1,80-	8 016604047954
4796	22-24	240	50	2,20-	8 016604047961



Reggipiante in bambù

Tutor de bambú

Bambus-Pflanzstäbe

Bamboo planting sticks



Art.	Ø mm	cm	# conf.	Pz./St.	€	EAN
4590	6-8	60	10	10	1,80-	8 016604045905
4591	8-10	90	10	10	2,60-	8 016604045912
4592	10-12	120	10	10	3,30-	8 016604045929
4593	14-16	150	5	10	3,20-	8 016604045936
4594	14-16	180	5	10	5,20-	8 016604045943
4595	16-18	210	3	10	4,50-	8 016604045950



Sostegni per piante
 Sostenes para plantas
 Rankhilfe
 Plant supports

Art.	cm	Gr.	Pz./St.	€	EAN
207	45		24	4,20-	8 016604 002076
208	60		24	5,50-	8 016604 002083
209	75		24	7,40-	8 016604 002090



Tutore semicircolare
 Tutor semicircular
 Halbrunder Pflanzstab
 Semicircular plant support

Art.	cm	Gr.	Pz./St.	€	EAN
222	40 x 35		24	3,80-	8 016604 002229
223	40 x 70		24	4,70-	8 016604 002236
224	40 x 100		24	6,20-	8 016604 002243



Tutore in plastica
 Elementi componibili fra loro.
 Tutor de plástico
 Elementos componibles entre ellos.
 Rankhilfe aus Kunststoff
 Elemente können zusammengesetzt werden.

Plastic plant trellis
 3 pieces. Add-on sections can be slot together.

Art.	cm	Pz./St.	€	EAN
45506	24,5 x 38,5	12	5,10-	8 016604 455063



Sostegno in bambù
 Sostén de bambú
 Rankhilfe aus Bambus
 Bamboo trellis

Art.	cm x cm	Pz./St.	€	EAN
45504	38 x h 60 cm	24	1,80-	8 016604 455049
45505	28 x h 60 cm	24	1,60-	8 016604 455056

Sostegni per piante 150 cm
 Pratici sostegni anche per piante di pomodori, di cetrioli e piante rampicanti. Set 3 aste con supporto intermedio.

Sostenes para plantas 150 cm
 Soportes para plantas de tomate, de pepino y plantas trepadoras. Set 3 varas con soporte intermedio.

Rankhilfe 150 cm
 Für Tomaten, Gurken und andere Rankpflanzen. Set, 3 plastifizierte Stahlstäbe inklusive Zwischenstreben.

Plant supports 150 cm
 Cucumbers, vine plants, and vegetables can also be used on this trellis. Included with a set of three plastic-steel rods.



• Montaggio veloce e facile!
 • Montaje fácil y rápido!
 • Schnelle und einfache Montage!
 • Fast and easy installation!

Art.	cm	Gr.	Pz./St.	€	EAN
206	h 150		24	9,30-	8 016604 002069



Espositore per canne
 Per un'esposizione ordinata del prodotto nel punto vendita.

Expositor para tutores
 Para una exposición ordenada del producto en el punto de venta.

Verkaufsständer für Pflanzstäbe
 Für eine geordnete Präsentation des Produkts am Point of Sale.

Display for plant supports
 For an organized exposition of the product in the shop.

Art.	m	Pz./St.	€	EAN
14	0,44 x 0,44 x h 0,85 m			8 016604 000140



Tutore a spirale
 In acciaio plastificato.

Tutor de espiral
 En acero plastificado.

Tomatenspiralen
 Hergestellt aus kunststoffbeschichtetem Stahl.

Spiral plant support
 In plasticised-steel.

Art.	Ø mm	cm	Pz./St.	€	EAN
210	10	150	10	3,60-	8 016604 002106
211	10	180	10	4,40-	8 016604 002113
212	10	210	10	4,90-	8 016604 002120





* fino ad esaurimento
* hasta agotamiento
* solange der Vorrat reicht
* While supplies last



- Lissi Mangiatoia da colorare KIDS GARDEN**
- Lissi Comedero para pintar KIDS GARDEN**
- Lissi Futterhaus zum anmalen KIDS GARDEN**
- Lissi paint a bird feeder KIDS GARDEN**

Art.	cm	Pz./St.	€	EAN
4415	22 x 16 x h 19 cm	4	45,40-	8 016604044151

* fino ad esaurimento
* hasta agotamiento
* solange der Vorrat reicht
* While supplies last



- Bibo Mangiatoia grande**
- Bibo Comedero grande**
- Bibo Futterhaus groß**
- Bibo large bird feeder**

Art.	cm	Pz./St.	€	EAN
4417	26,5 x 17 x h 21 cm	8	39,20-	8 016604044175

* fino ad esaurimento
* hasta agotamiento
* solange der Vorrat reicht
* While supplies last

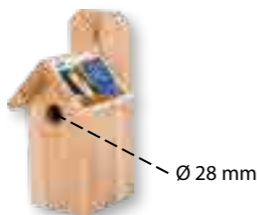

- Ninna Casetta per gli uccelli**
- Ninna Casita para los pájaros**
- Ninna Nistkasten**
- Ninna birdhouse**

Art.	cm	Pz./St.	€	EAN
4409	13 x 13 x h 26 cm	4	20,30-	8 016604044090

* fino ad esaurimento
* hasta agotamiento
* solange der Vorrat reicht
* While supplies last

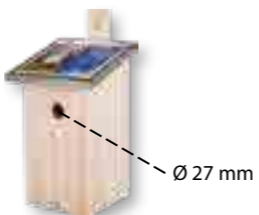

- Fipsi Casetta per uccelli**
- Fipsi Casita para pájaros**
- Fipsi Nistkasten**
- Fipsi birdhouse**

Art.	cm	Pz./St.	€	EAN
4418	16 x 17 x h 32 cm	4	39,20-	8 016604044182

* fino ad esaurimento
* hasta agotamiento
* solange der Vorrat reicht
* While supplies last



- Tiffi Casetta per uccelli**
- Tiffi Casita para pájaros**
- Tiffi Nistkasten**
- Tiffi birdhouse**

Art.	cm	Pz./St.	€	EAN
4419	18 x 14,5 x h 27,5 cm	4	30,80-	8 016604044199

* fino ad esaurimento
* hasta agotamiento
* solange der Vorrat reicht
* While supplies last



- Trixi Mangiatoia piccola**
- Trixi Comedero pequeño**
- Trixi Futterhaus klein**
- Trixi small bird feeder**

Art.	cm	Pz./St.	€	EAN
4416	16 x 21 x h 22 cm	4	28,00-	8 016604044168

* fino ad esaurimento
* hasta agotamiento
* solange der Vorrat reicht
* While supplies last



- Apply Mangiatoia per mela**
- Apply Comedero para manzana**
- Apply Apfelhäuschen**
- Apply bird feeder**

Art.	cm	Pz./St.	€	EAN
4411	18 x 7 x h 20 cm	6	14,00-	8 016604044113

* fino ad esaurimento
* hasta agotamiento
* solange der Vorrat reicht
* While supplies last



- Twisty Mangiatoia a spirale**
- Twisty Comedero de espiral**
- Twisty Futterfeder**
- Twisty spiral bird feeder**

Art.	Ø x cm	Pz./St.	€	EAN
4410	Ø 7 cm x h 12cm	12	5,90-	8 016604044106



- Cappello in paglia KIDS GARDEN**
- Sombrero de paja KIDS GARDEN**
- Strohhut KIDS GARDEN**
- Straw hat KIDS GARDEN**

Art.	mis./Gr.	Pz./St.	€	EAN
1601	53	12	6,90-	8 016604016011



- Cappello in paglia da donna**
- Sombrero de paja para mujer**
- Damenstrohhtut**
- Straw hat for women**

Art.	mis./Gr.	Pz./St.	€	EAN
1606	55-56	12	9,10-	8 016604016066



- Cappello in paglia da donna**
- Sombrero de paja para mujer**
- Damenstrohhtut**
- Straw hat for women**

Art.	mis./Gr.	Pz./St.	€	EAN
1607	55-56	12	6,80-	8 016604016073



- Cappello in paglia da donna**
- Sombrero de paja para mujer**
- Damenstrohhtut**
- Straw hat for women**

Art.	mis./Gr.	Pz./St.	€	EAN
1608	55-56	12	10,50-	8 016604016080



- Cappello in paglia da donna**
- Sombrero de paja para mujer**
- Damenstrohhtut**
- Straw hat for women**

Art.	mis./Gr.	Pz./St.	€	EAN
1609	55-56	12	7,70-	8 016604016097



- Cappello in paglia da uomo**
- Sombrero de paja para hombre**
- Herrenstrohhtut**
- Straw hat for men**

Art.	mis./Gr.	Pz./St.	€	EAN
1602	56 - 58 - 60	12	9,50-	8 016604016028



- Cappello in paglia da uomo**
- Sombrero de paja para hombre**
- Herrenstrohhtut**
- Straw hat for men**

Art.	mis./Gr.	Pz./St.	€	EAN
1604	56 - 58 - 60	12	6,70-	8 016604016042



- Cappello in paglia da uomo**
- Sombrero de paja para hombre**
- Herrenstrohhtut**
- Straw hat for men**

Art.	mis./Gr.	Pz./St.	€	EAN
1611	56	12	6,70-	8 016604016110

Art.	mis./Gr.	Pz./St.	€	EAN
1610	58	12	6,70-	8 016604016103



- Cappello in paglia da uomo**
- Sombrero de paja para hombre**
- Herrenstrohhtut**
- Straw hat for men**

Art.	mis./Gr.	Pz./St.	€	EAN
1603	56 - 58 - 60	12	13,40-	8 016604016035



- Cappello in paglia da uomo**
- Sombrero de paja para hombre**
- Herrenstrohhtut**
- Straw hat for men**

Art.	mis./Gr.	Pz./St.	€	EAN
1605	56 - 58 - 60	12	8,10-	8 016604016059





Espositore girevole con ruote

Girevole e con ruote, facile da spostare all'interno del punto vendita durante le varie stagioni. Lunghezza ganchi: 40 cm. Per un'esposizione del prodotto ordinata e curata.

Expositor giratorio con ruedas

Giratorio y con ruedas, fácil de mover por la tienda durante las distintas temporadas. Longitud ganchos: 40 cm. Para una exposición del producto ordenada y curada.

Gartenschuh-Verkaufsständer

Drehbar und mit Rollen ausgestattet für einfaches verstellen im Saisonswechsel. Länge der Haken: 40 cm. Für eine saubere und genaue Darstellung des Produkts.

Revolving display with wheels

Rotating, with wheels, easy to move around in the shop as seasons change. Hooks length: 40 cm. For an organized exposition of the product.

Art.	cm x m	Pz./St.	€	EAN
24	Ø 80 cm x h 1,9 m			8 016604 900242

* Con gancio per esposizione
* Con gancho para exposición
* Mit Haken für Verkaufsständer
* With hook for display

Art.	mis./Gr.	col./Farbe	Pz./St.	€	EAN
1036	36	■	4	15,70-	8 016604 010361
1037	37	■	4	15,70-	8 016604 010378
1038	38	■	4	15,70-	8 016604 010385
1039	39	■	4	15,70-	8 016604 010392
1040	40	■	4	15,70-	8 016604 010408
1041	41	■	4	18,10-	8 016604 010415
1042	42	■	4	18,10-	8 016604 010422
1043	43	■	4	18,10-	8 016604 010439
1044	44	■	4	18,10-	8 016604 010446
1045	45	■	4	18,10-	8 016604 010453
1046	46	■	4	18,10-	8 016604 010460



Zoccoli giardino e casa
 Zuecos para jardín y casa
 Haus- und Gartenschuhe
 Home and garden shoes

* Con gancio per esposizione
* Con gancho para exposición
* Mit Haken für Verkaufsständer
* With hook for display

Art.	mis./Gr.	col./Farbe	Pz./St.	€	EAN
1136	36	■	4	15,70-	8 016604 011368
1137	37	■	4	15,70-	8 016604 011375
1138	38	■	4	15,70-	8 016604 011382
1139	39	■	4	15,70-	8 016604 011399
1140	40	■	4	15,70-	8 016604 011405
1141	41	■	4	18,10-	8 016604 011412
1142	42	■	4	18,10-	8 016604 011429
1143	43	■	4	18,10-	8 016604 011436
1144	44	■	4	18,10-	8 016604 011443
1145	45	■	4	18,10-	8 016604 011450
1146	46	■	4	18,10-	8 016604 011467



Zoccoli giardino e casa
 Zuecos para jardín y casa
 Haus- und Gartenschuhe
 Home and garden shoes

* Con gancio per esposizione
* Con gancho para exposición
* Mit Haken für Verkaufsständer
* With hook for display

Art.	mis./Gr.	col./Farbe	Pz./St.	€	EAN
3236	36	■	4	15,70-	8 016604 032363
3237	37	■	4	15,70-	8 016604 032370
3238	38	■	4	15,70-	8 016604 032387
3239	39	■	4	15,70-	8 016604 032394
3240	40	■	4	15,70-	8 016604 032400
3241	41	■	4	18,10-	8 016604 032417
3242	42	■	4	18,10-	8 016604 032424
3243	43	■	4	18,10-	8 016604 032431
3244	44	■	4	18,10-	8 016604 032448
3245	45	■	4	18,10-	8 016604 032455
3246	46	■	4	18,10-	8 016604 032462



Zoccoli giardino e casa
 Zuecos para jardín y casa
 Haus- und Gartenschuhe
 Home and garden shoes

* Con gancio per esposizione
* Con gancho para exposición
* Mit Haken für Verkaufsständer
* With hook for display

Art.	mis./Gr.	col./Farbe	Pz./St.	€	EAN
3336	36	■	4	16,20-	8 016604033360
3337	37	■	4	16,20-	8 016604033377
3338	38	■	4	16,20-	8 016604033384
3339	39	■	4	16,20-	8 016604033391
3340	40	■	4	16,20-	8 016604033407
3341	41	■	4	19,80-	8 016604033414
3342	42	■	4	19,80-	8 016604033421
3343	43	■	4	19,80-	8 016604033438
3344	44	■	4	19,80-	8 016604033445
3345	45	■	4	19,80-	8 016604033452
3346	46	■	4	19,80-	8 016604033469



- Zoccoli giardino e casa perforato nero
- Zuecos para jardín y casa perforado negro
- Gelochte Haus- und Gartenschuhe schwarz
- Home and garden shoes perforated black

* Con gancio per esposizione
* Con gancho para exposición
* Mit Haken für Verkaufsständer
* With hook for display



- Zoccoli giardino e casa perforato rosa
- Zuecos para jardín y casa perforado rosa
- Gelochte Haus- und Gartenschuhe Pink
- Home and garden shoes perforated pink

Art.	mis./Gr.	col./Farbe	Pz./St.	€	EAN
3436	36	■	4	16,20-	8 016604034367
3437	37	■	4	16,20-	8 016604034374
3438	38	■	4	16,20-	8 016604034381
3439	39	■	4	16,20-	8 016604034398
3440	40	■	4	16,20-	8 016604034404
3441	41	■	4	19,80-	8 016604034411

* Con gancio per esposizione
* Con gancho para exposición
* Mit Haken für Verkaufsständer
* With hook for display



- Zoccoli giardino e casa perforato blu
- Zuecos para jardín y casa perforado azul
- Gelochte Haus- und Gartenschuhe Blau
- Home and garden shoes perforated blue

Art.	mis./Gr.	col./Farbe	Pz./St.	€	EAN
3636	36	■	4	16,20-	8 016604036361
3637	37	■	4	16,20-	8 016604036378
3638	38	■	4	16,20-	8 016604036385
3639	39	■	4	16,20-	8 016604036392
3640	40	■	4	16,20-	8 016604036408
3641	41	■	4	19,80-	8 016604036415

* Con gancio per esposizione
* Con gancho para exposición
* Mit Haken für Verkaufsständer
* With hook for display



- Zoccoli giardino e casa perforato blu
- Zuecos para jardín y casa perforado azul
- Gelochte Haus- und Gartenschuhe Blau
- Home and garden shoes perforated blue

Art.	mis./Gr.	col./Farbe	Pz./St.	€	EAN
3442	42	■	4	19,80-	8 016604034428
3443	43	■	4	19,80-	8 016604034435
3444	44	■	4	19,80-	8 016604034442
3445	45	■	4	19,80-	8 016604034459
3446	46	■	4	19,80-	8 016604034466

* Con gancio per esposizione
* Con gancho para exposición
* Mit Haken für Verkaufsständer
* With hook for display



- Zoccoli giardino e casa perforato lime
- Zuecos para jardín y casa perforado lima
- Gelochte Haus- und Gartenschuhe Limette
- Home and garden shoes perforated lime

Art.	mis./Gr.	col./Farbe	Pz./St.	€	EAN
3642	42	■	4	19,80-	8 016604036422
3643	43	■	4	19,80-	8 016604036439
3644	44	■	4	19,80-	8 016604036446
3645	45	■	4	19,80-	8 016604036453
3646	46	■	4	19,80-	8 016604036460

* Con gancio per esposizione
* Con gancho para exposición
* Mit Haken für Verkaufsständer
* With hook for display

KIDS
GARDEN



- Zoccoli da giardino KIDS GARDEN perforato verde
- Comodi e leggerissimi, in morbido materiale EVA antiscivolo e resistente all'abrasione. Chiusura a sandalo che evita che lo zoccolo si sfili.

- Zuecos de jardín KIDS GARDEN perforado verde
- Cómodi y muy ligeros, de suave material EVA antideslizante y resistente a la abrasión. Cierre de sandalia que evita que el zueco se quite.

- Gelochte Gartenschuhe KIDS GARDEN Grün
- Komfortabel und leicht, aus weichem, rutschfestem, abriebfestem EVA-Material. Sandalenverschluss, für einen besseren Halt.

- Garden shoes KIDS GARDEN perforated green
- Comfortable and super-light, made from soft EVA rubber, non slip and abrasionresistant. Back-closure that avoids losing the shoe.

Art.	mis./Gr.	col./Farbe	Pz./St.	€	EAN
3726	26-27	■	4	14,40-	8 016604037269
3728	28-29	■	4	14,40-	8 016604037283
3730	30-31	■	4	14,40-	8 016604037306
3732	32-33	■	4	14,40-	8 016604037320
3734	34-35	■	4	14,40-	8 016604037344

* Con gancio per esposizione
* Con gancho para exposición
* Mit Haken für Verkaufsständer
* With hook for display

KIDS
GARDEN



- Zoccoli da giardino KIDS GARDEN perforato arancione
- Comodi e leggerissimi, in morbido materiale EVA antiscivolo e resistente all'abrasione. Chiusura a sandalo che evita che lo zoccolo si sfili.

- Zuecos de jardín KIDS GARDEN perforado naranja
- Cómodi y muy ligeros, de suave material EVA antideslizante y resistente a la abrasión. Cierre de sandalia que evita que el zueco se quite.

- Gelochte Gartenschuhe KIDS GARDEN Orange
- Komfortabel und leicht, aus weichem, rutschfestem, abriebfestem EVA-Material. Sandalenverschluss, für einen besseren Halt.

- Garden shoes KIDS GARDEN perforated orange
- Comfortable and super-light, made from soft EVA rubber, non slip and abrasionresistant. Back-closure that avoids losing the shoe.

Art.	mis./Gr.	col./Farbe	Pz./St.	€	EAN
3826	26-27	■	4	14,40-	8 016604038266
3828	28-29	■	4	14,40-	8 016604038280
3830	30-31	■	4	14,40-	8 016604038303
3832	32-33	■	4	14,40-	8 016604038327
3834	34-35	■	4	14,40-	8 016604038341

Art.	mis./Gr.	col./Farbe	Pz./St.	€	EAN
2535	35	■	3	35,80-	8 016604025358
2536	36	■	3	35,80-	8 016604025365
2537	37	■	3	35,80-	8 016604025372
2538	38	■	3	35,80-	8 016604025389
2539	39	■	3	35,80-	8 016604025396
2540	40	■	3	35,80-	8 016604025402
2541	41	■	3	35,80-	8 016604025419



- Stivali di gomma**
Ideali per il giardino e il tempo libero.
- Botas de goma**
Ideales para el jardín y el tiempo libre.
- Gummistiefel**
Für Garten und Freizeit.
- Rain boots**
Ideal for the garden and free-time.

Art.	mis./Gr.	col./Farbe	Pz./St.	€	EAN
1835	35	■	3	35,80-	8 016604918353
1836	36	■	3	35,80-	8 016604918360
1837	37	■	3	35,80-	8 016604918377
1838	38	■	3	35,80-	8 016604918384
1839	39	■	3	35,80-	8 016604918391
1840	40	■	3	35,80-	8 016604918407
1841	41	■	3	35,80-	8 016604918414



- Stivali di gomma**
Ideali per il giardino e il tempo libero.
- Botas de goma**
Ideales para el jardín y el tiempo libre.
- Gummistiefel**
Für Garten und Freizeit.
- Rain boots**
Ideal for the garden and free-time.

Art.	mis./Gr.	col./Farbe	Pz./St.	€	EAN
1935	35	■	3	35,80-	8 016604919350
1936	36	■	3	35,80-	8 016604919367
1937	37	■	3	35,80-	8 016604919374
1938	38	■	3	35,80-	8 016604919381
1939	39	■	3	35,80-	8 016604919398
1940	40	■	3	35,80-	8 016604919404
1941	41	■	3	35,80-	8 016604919411



- Stivali di gomma**
Ideali per il giardino e il tempo libero.
- Botas de goma**
Ideales para el jardín y el tiempo libre.
- Gummistiefel**
Für Garten und Freizeit.
- Rain boots**
Ideal for the garden and free-time.

* Con gancio per esposizione
* Con gancho para exposición
* Mit Haken für Verkaufsständer
* With hook for display

* fino ad esaurimento
* hasta agotamiento
* solange der Vorrat reicht
* While supplies last

- Stivali rana KIDS GARDEN**
- Botas rana KIDS GARDEN**
- Pirat Stiefel KIDS GARDEN**
- Rain boots frog KIDS GARDEN**



Art.	mis./Gr.	col./Farbe	Pz./St.	€	EAN
1821	21	■	12	19,20-	8 016604018213
1822	22	■	12	19,20-	8 016604018220
1823	23	■	12	19,20-	8 016604018237
1824	24	■	12	19,20-	8 016604018244
1825	25	■	12	19,20-	8 016604018251
1826	26	■	12	19,20-	8 016604018268
1827	27	■	12	19,20-	8 016604018275
1828	28	■	12	19,20-	8 016604018282
1829	29	■	12	19,20-	8 016604018299
1830	30	■	12	19,20-	8 016604018305
1831	31	■	12	19,20-	8 016604018312
1832	32	■	12	19,20-	8 016604018329
1833	33	■	12	19,20-	8 016604018336
1834	34	■	12	19,20-	8 016604018343
2135	35	■	12	19,20-	8 016604021350

* Con gancio per esposizione
* Con gancho para exposición
* Mit Haken für Verkaufsständer
* With hook for display

* fino ad esaurimento
* hasta agotamiento
* solange der Vorrat reicht
* While supplies last

- Stivali pirata KIDS GARDEN**
- Botas pirata KIDS GARDEN**
- Pirat Stiefel KIDS GARDEN**
- Rain boots pirate KIDS GARDEN**

* fino ad esaurimento
* hasta agotamiento
* solange der Vorrat reicht
* While supplies last

Art.	mis./Gr.	col./Farbe	Pz./St.	€	EAN
1127	27	■	24	22,40-	8 016604011276
1128	28	■	24	22,40-	8 016604011283
1129	29	■	24	22,40-	8 016604011290
1130	30	■	24	22,40-	8 016604011306
1131	31	■	24	22,40-	8 016604011313
1132	32	■	24	22,40-	8 016604011320
1133	33	■	24	22,40-	8 016604011337
1134	34	■	24	22,40-	8 016604011344
1135	35	■	24	22,40-	8 016604011351

* Con gancio per esposizione
* Con gancho para exposición
* Mit Haken für Verkaufsständer
* With hook for display

* fino ad esaurimento
* hasta agotamiento
* solange der Vorrat reicht
* While supplies last

- Stivali farfalla KIDS GARDEN**
- Botas mariposa KIDS GARDEN**
- Stiefel Schmetterling KIDS GARDEN**
- Rain boots butterfly KIDS GARDEN**



Art.	mis./Gr.	col./Farbe	Pz./St.	€	EAN
2821	21	■	12	19,20-	8 016604028212
2822	22	■	12	19,20-	8 016604028229
2823	23	■	12	19,20-	8 016604028236
2824	24	■	12	19,20-	8 016604028243
2825	25	■	12	19,20-	8 016604028250
2826	26	■	12	19,20-	8 016604028267
2827	27	■	12	19,20-	8 016604028274
2828	28	■	12	19,20-	8 016604028281
2829	29	■	12	19,20-	8 016604028298
2830	30	■	12	19,20-	8 016604028304
2831	31	■	12	19,20-	8 016604028311
2832	32	■	12	19,20-	8 016604028328
2833	33	■	12	19,20-	8 016604028335
2834	34	■	12	19,20-	8 016604028342
2835	35	■	12	19,20-	8 016604028359

* Con gancio per esposizione
* Con gancho para exposición
* Mit Haken für Verkaufsständer
* With hook for display

* fino ad esaurimento
* hasta agotamiento
* solange der Vorrat reicht
* While supplies last



stocker

www.stockergarden.com

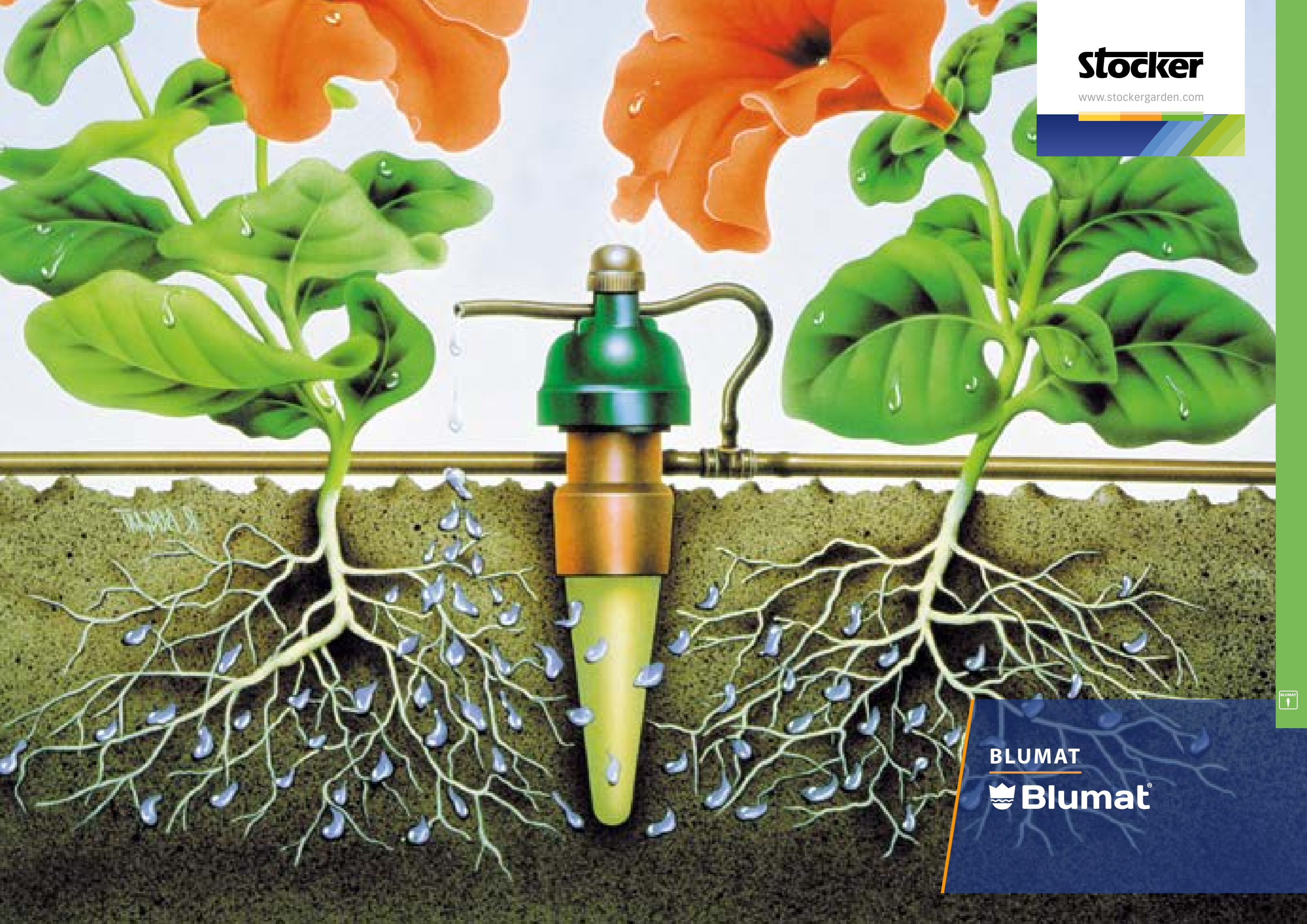

BLUMAT

 **Blumat®**

BLUMAT
↓



BLUMAT Display
In espositore da banco da 25 pezzi, per piante singole.

BLUMAT Expositor
En expositor de banco de 25 unidades, para plantas individuales.

BLUMAT Display
Im Verkaufsständer zu 25 Stück, für Einzelpflanzen.

BLUMAT Display
The display stand can hold 25 individual plants.

Art.	cm	Gr.	Pz./St.	€	EAN
12500			4	120,00-	9 002683 012500



BLUMAT espositore per adattatore per bottiglie 3 pz
BLUMAT expositor para adaptador para botellas 3 pzs
BLUMAT Verkaufdisplay für Flaschenadapter 3 Stk.
BLUMAT Display for adapter for bottles 3 pcs

Art.	cm	Gr.	Pz./St.	€	EAN
23308			80	14,10-	9 002683 023308

BLUMAT
BLUMAT
BLUMAT
BLUMAT



Art.	cm	Gr.	Pz./St.	€	EAN
10308			12	14,60-	9 002683 010308

BLUMAT XL In blister da 2 pezzi.
BLUMAT XL En blister de 2 piezas.
BLUMAT XL Im Blister zu 2 Stück.
BLUMAT XL 2 pieces per pack.

Art.	cm	Gr.	Pz./St.	€	EAN
10520			6	15,80-	9 002683 010520

BLUMAT
BLUMAT
BLUMAT
BLUMAT



Art.	cm	Gr.	Pz./St.	€	EAN
11100			30	5,60-	9 002683 010315



BLUMAT Adattatore bottiglie XL
BLUMAT Adaptador botellas XL
BLUMAT Flaschenadapter XL
BLUMAT Bottle adapter XL

Art.	cm	Gr.	Pz./St.	€	EAN
22202			5	14,80-	9 002683 022202



Sistema di irrigazione semplice ed efficace ideale per piante da balcone e giardino. Gli adattatori sono compatibili con tutti i colli delle bottiglie di plastica da 0,25 a 2 l in commercio. L'adattatore XL è consigliato per vasi grandi. Eroga una quantità di acqua pari a 300 ml/24 h.

Sistema de riego simple y eficaz, ideal para plantas de balcón y jardín. Se adapta a todos los cuellos de botellas que se comercializan de 0,25

a 2 lt. El adaptador XL está pensado para macetas grandes. Puede llegar a regar una cantidad de agua hasta de 300 ml en 24 h.

Einfaches Bewässerungssystem speziell für Pflanzen auf dem Balkon oder im Garten. Auf die Adapter passen fast alle handelsüblichen Kunststoffflaschen von 0,25 - 2 l. Der Flaschenadapter XL ist geeignet für große Pflanztopfe mit Wasserabgabe von 300 ml/24 h.

Simple Irrigation System made especially for plants on a balcony or in the garden. The adapter fits nearly all commercially available plastic bottles (for sizes: 0.25 to 2 l). Bottle Adapter XL is suitable for large potted plants with a water levy of 300 ml/24 h.

BLUMAT Tropf Maxi
BLUMAT Tropf Maxi
BLUMAT Tropf Maxi
BLUMAT Tropf Maxi



Art.	cm	Gr.	Pz./St.	€	EAN
33000			5	22,70-	9 002683 033000

BLUMAT Tropf Sfuso.
BLUMAT Tropf Granel.
BLUMAT Tropf Lose.
BLUMAT Tropf Sold individually.



Art.	cm	Gr.	Pz./St.	€	EAN
35100			50	6,60-	9 002683 035103

BLUMAT Tropf
BLUMAT Tropf
BLUMAT Tropf
BLUMAT Tropf



Art.	cm	Gr.	Pz./St.	€	EAN
32003			5	15,90-	9 002683 032003

BLUMAT Sensore digitale d'umidità
BLUMAT Sensor digital de humedad
BLUMAT Digital-Feuchtesensor
BLUMAT Digital humidity sensor



Art.	cm	Gr.	Pz./St.	€	EAN
50205			25	76,20-	9 002683 050205

BLUMAT Tropf Set
Da 10 m. Completo di 40 annaffiatori, 15 m di tubo Ø 8 mm, riduttore di pressione, raccordi per tubo.



BLUMAT Tropf Set
De 10 m. Completo con 40 regadores, 15 m de tubo de Ø 8 mm, reductor de presión y conectores para tubo.

BLUMAT Tropf Set
10 m. Komplet mit 40 Tropf-Blumat, 15 m Schlauch Ø 8 mm, Schlauchanschluss.

BLUMAT Tropf Set
10 m. Complete with 40 drop Blumats, 15 m Ø 8 mm, Hose connection.

Art.	cm	Gr.	Pz./St.	€	EAN
31006			8	324,00-	9 002683 031006

BLUMAT Tropf Set di base
Completo di 12 annaffiatori, 7 m di tubo Ø 8 mm, raccordi per tubo.



BLUMAT Tropf Set básico
Completo con 12 regadores, 7 m de tubo de Ø 8 mm y conectores para tubo.

BLUMAT Tropf Basis-Set
Komplett mit 12 Tropf-Blumat, 7 m Schlauch Ø 8 mm, Schlauchanschluss.

BLUMAT Tropf Basic set
Complete with 12 drop Blumats, 7 m hose Ø 8 mm, Hose connection.

Art.	cm	Gr.	Pz./St.	€	EAN
30009			16	93,10-	9 002683 030009



BLUMAT Pezzo terminale Sfuso.
 BLUMAT Pieza terminal Granel.
 BLUMAT Endstück Lose.
 BLUMAT End piece Sold individually.

Art.	cm	Gr.	Pz./St.	€	EAN
3512			50	1,20-	

BLUMAT Mini giunto di ramificazione 8 mm e 3 mm, sfuso e in blister.
 BLUMAT Mini junta de ramificación 8 mm y 3 mm, granel y en blister.
 BLUMAT Mini-Abzweiger 8 mm und 3 mm, lose und im Blister.
 BLUMAT Mini hose connection 8 mm and 3 mm, sold individually and in pack.

Art.	cm	Gr.	Pz./St. conf.	Pz./St.	€	EAN
3517				50	1,20-	
32409		3		10	4,00-	9 002683 032409

BLUMAT Giunto di ramificazione per tubo Sfuso e in blister.
 BLUMAT Junta de ramificación para tubo Granel y en blister.
 BLUMAT Schlauchverbinder Lose und im Blister.
 BLUMAT Hose connection Sold individually and in pack.

Art.	cm	Gr.	Pz./St. conf.	Pz./St.	€	EAN
3519				50	1,20-	
32805		3		10	4,00-	9 002683 032805

BLUMAT Irrigatore a goccia Sfuso.
 BLUMAT Aspersor por goteo Granel.
 BLUMAT Verteilertropfer Lose.
 BLUMAT Dripper Sold individually.

Art.	cm	Gr.	Pz./St.	€	EAN
4300			50	1,40-	

BLUMAT Ramificazione e pezzo terminale 2 pezzi.
 BLUMAT Ramificación y pieza terminal 2 piezas.
 BLUMAT Schlauchabzweiger und Endstück 2 Stück.
 BLUMAT Connection and end piece 2 pieces.

Art.	cm	Gr.	Pz./St.	€	EAN
32904			10	3,60-	9 002683 032904

BLUMAT Riduttore di pressione
 BLUMAT Reductor de presión
 BLUMAT Druckreduzierer
 BLUMAT pressure reducer

Art.	cm	Gr.	Pz./St.	€	EAN
36001			2	50,20-	9 002683 036001

BLUMAT Giunto di ramificazione 8 mm, sfuso.
 BLUMAT Junta de ramificación 8 mm, granel.
 BLUMAT Abzweiger 8 mm, lose.
 BLUMAT Hose connection 8 mm, sold individually.

Art.	cm	Gr.	Pz./St.	€	EAN
3516			50	1,20-	

BLUMAT Mini giunto di ramificazione 3 mm, sfuso e in blister.
 BLUMAT Mini junta de ramificación 3 mm, granel y en blister.
 BLUMAT Mini-Abzweiger 3 mm, lose und im Blister.
 BLUMAT Mini hose connection 3 mm, sold individually and in pack.

Art.	cm	Gr.	Pz./St. conf.	Pz./St.	€	EAN
3412				50	1,30-	
32119		3		10	4,00-	9 002683 032119

BLUMAT Giunto a gomito Sfuso e in blister.
 BLUMAT Junta de codo Granel y en blister.
 BLUMAT Winkel Lose und im Blister.
 BLUMAT Elbow hose connection Sold individually and in pack.

Art.	cm	Gr.	Pz./St. conf.	Pz./St.	€	EAN
3513				50	1,20-	
32706		3		10	4,00-	9 002683 032706

BLUMAT Irrigatore a goccia finale Sfuso.
 BLUMAT Aspersor por goteo final Granel.
 BLUMAT Endverteilertropfer Lose.
 BLUMAT Final dripper Sold individually.

Art.	cm	Gr.	Pz./St.	€	EAN
4301			50	1,40-	

BLUMAT Set irrigatori a goccia Tubo da 2 m e 10 irrig.
 BLUMAT Set aspersores por goteo Tubo de 2 m e 10 aspersores.
 BLUMAT Verteilertropfer Tropfschlauch von 2 m und 10 Verteilertropfer.
 BLUMAT Drippers set 2 m hose and 10 irrig.

Art.	cm	Gr.	Pz./St.	€	EAN
41005			10	20,40-	9 002683 041005

BLUMAT Attacco tanica
 BLUMAT Conexión tanque
 BLUMAT Hochtankanschluss
 BLUMAT Tank connection

Art.	cm	Gr.	Pz./St.	€	EAN
30238			5	3,60-	9 002683 030238

BLUMAT Morsetto di sicurezza In blister.
 BLUMAT Abrazadera de seguridad En blister.
 BLUMAT Schlauchsicherungs-Klemme Im Blister.
 BLUMAT Hose clamp 1 clamp per pack.

Art.	cm	Gr.	Pz./St.	€	EAN
43009			10	13,00-	9 002683 043009

BLUMAT Tubo irrigazione a goccia Ø 3 mm, 3 m.
 BLUMAT Tubo irrigación por goteo Ø 3 mm, 3 m.
 BLUMAT Tropfschlauch Ø 3 mm, 3 m.
 BLUMAT Dripper hose Ø 3 mm, 3 m.

Art.	cm	Gr.	Pz./St.	€	EAN
35189			10	9,80-	9 002683 035189

BLUMAT Tappo Per Art. 35100, 32003. Sfuso.
 BLUMAT Tapón Para art. 35100, 32003. Granel.
 BLUMAT Abdeckkappe Für Art. 35100, 32003. Lose.
 BLUMAT Cap For item 35100, 32003. Sold individually.

Art.	cm	Gr.	Pz./St.	€	EAN
3411			50	0,80-	

BLUMAT Tubo di alimentazione Nero, sfuso.
 BLUMAT Tubo de alimentación Negro, granel.
 BLUMAT Zufuhrschlauch Schwarz, lose.
 BLUMAT Delivery hose Black, sold individually.

Art.	Ø mm	m	Pz./St.	€	EAN
30405	8 mm	10 m	1	14,90-	9 002683 030405
3045	8 mm	50 m	1	68,50-	8 016604 030451

BLUMAT Sostegno per tubo e distributori
 BLUMAT Sostén para tubo y distribuidores
 BLUMAT Stützen für Zufuhrschlauch und Verteilertropfer
 BLUMAT Hose and drippers support

Art.	cm	Gr.	Pz./St. conf.	Pz./St.	€	EAN
4305				50	0,60-	
42002			10	10	10,30-	9 002683 042002

BLUMAT Valvola di arresto In blister.
 BLUMAT Válvula de bloqueo En blister.
 BLUMAT Absperrventil Im Blister.
 BLUMAT Shut-off valve 1 piece per pack.

Art.	cm	Gr.	Pz./St.	€	EAN
32102			10	6,00-	9 002683 032102

BLUMAT Tubo per irrigazione
 BLUMAT Tubo para irrigación
 BLUMAT Tropfschlauch
 BLUMAT Dripper hose

Art.	Ø mm	m	Pz./St.	€	EAN
3501	3 mm	10 m	1	18,90-	8 016604 035012
3502	3 mm	20 m	1	38,00-	8 016604 035029
3503	3 mm	50 m	1	100,50-	8 016604 035036

BLUMAT Tubo di alimentazione Bianco, sfuso.
 BLUMAT Tubo de alimentación Blanco, granel.
 BLUMAT Zufuhrschlauch Weiß, lose.
 BLUMAT Delivery hose White, sold individually.

Art.	Ø mm	m	Pz./St.	€	EAN
30504	8 mm	10 m	6	22,10-	9 002683 030504
3046	8 mm	50 m	1	93,20-	8 016604 030468



stocker

www.stockergarden.com

ESPOSITORI

EXPOSITORES
VERKAUFSTÄNDER
DISPLAY CASES

- Espositore schienale**
- Expositor respaldo**
- Verkaufsständer Rücken**
- Display Peforated back wall**



Art.	cm	Gr.	Pz./St.	€	EAN
30					8 016604 000300

- Espositore staffa montante**
Per un metro di espositore occorrono due staffe. Per ogni metro aggiuntivo occorre aggiungere una staffa.

- Expositor soporte montante**
Para un metro de expositor se necesitan dos soportes. Por cada metro adicional es necesario agregar un soporte.

- Verkaufsständer montierte Stützen**
2 Stützen für einen Verkaufsständer zu 1 m. Die Anzahl der Stützen hängt von der Länge des Verkaufsständers ab.

- Display structure clamp**
2 supports for 1 display rack. 2 supports for 1 display for a meter. The quantity of the supports depends on the number of grid walls.

Art.	cm	Gr.	Pz./St.	€	EAN
31					8 016604 000317

- Espositore scaffale inferiore**
- Expositor estante inferior**
- Verkaufsständer untere Regale**
- Display bottom part**



Art.	cm	Gr.	Pz./St.	€	EAN
32					8 016604 000324

- Espositore Logo**
Sono disponibili diversi crowner a seconda della merce che verrà esposta.

- Expositor Logo**
Son disponibles diversos logotipos según la mercancía que será expuesta.

- Verkaufsständer Logo**
Je nach Bedarf sind verschiedene Aufkleber verfügbar.

- Display Logo**
Different themes are available, basing on the sold product.



Art.	cm	Gr.	Pz./St.	€	EAN
34					8 016604 000348

- Espositore scaffali ripiani**
- Expositor estantes repisas**
- Verkaufsständer Regale**
- Display shelves**



Art.	cm	Gr.	Pz./St.	€	EAN
33					8 016604 000331

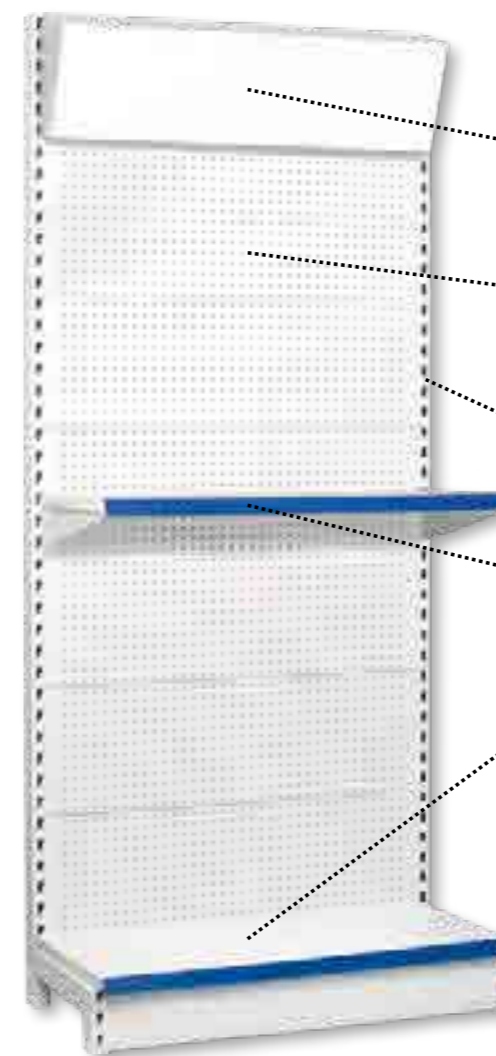

Art. 34

Art. 30

Art. 31

Art. 33

Art. 32

DISPLAY

COMPONENTI COMPATIBILI PER SCHIENALE ART. 30

COMPONENTES COMPATIBLES CON EL RESPALDO ART. 30
 KOMPATIBLE KOMPONENTEN FÜR RÜCKENTEIL ART. 30
 COMPATIBLE COMPONENTS FOR THE DISPLAY BACKREST ITEM 30

Art.
30

- Espositore contenitore raccordi**
Perfetto per presentare tutti i tipi di raccordi in modo ordinato.
- Expositor contenedor conectores**
Perfecto para la presentación de todo tipo de conectores de modo ordenado.
- Verkaufsständer für Armaturen**
Perfekte Präsentation unseres Armaturensortiments durch das Integrieren des Behälters in den Verkaufsständer.
- Display connector box**
For a perfect presentation of our faucet assortment. Easy to install at the back of the display case.

Art.	cm	Gr.	Pz./St.	€	EAN
35					8 016604 000355



- Espositore Combisystem**
Grazie all'espositore il prodotto si presenta perfettamente ottimizzando gli spazi.
- Expositor Combisystem**
Gracias al expositor los productos se presentan perfectamente optimizando los espacios.
- Verkaufsständer Kombisystem**
Mit seiner Hilfe kann die Kombisystem-Linie ideal in den Verkaufsständer integriert und perfekt präsentiert werden.
- Display Combisystem**
Presents perfectly our combisystem line.

Art.	cm	Gr.	Pz./St.	€	EAN
36					8 016604 000362



- Espositore cestino metallico**
- Expositor cesto metálico**
- Verkaufsständer Metallregalkorb**
- Display metal basket**

Art.	cm	Gr.	Pz./St.	€	EAN
37					8 016604 000379



- Espositore griglia separatrice per cestino metallico**
- Expositor parrilla separadora para cesta metálica**
- Verkaufsständer Metallregalkorb-Abtrennung**
- Display spacer-grid for metal basket**

Art.	cm	Gr.	Pz./St.	€	EAN
38					8 016604 000386



- Espositore gancho**
 - Expositor gancho**
 - Verkaufsständer Haken**
 - Display hook**
- * con portaprezzi
 * con soporte para precios
 * mit Preisschildhalter
 * with price tag holder

Art.	cm	Gr.	Pz./St.	€	EAN
40*	20				8 016604 000409
41*	31,5				8 016604 000416



- Espositore per forbici elettriche con ganchi per schienale**
 - Expositor para tijeras eléctricas con ganchos para respaldo**
 - Verkaufsständer für elektrische Baumscheren mit Haken für Rückenteil**
 - Display for electric pruning shears with hooks for back wall**
- per /para /für /for Art. 310, 311, 312, 313, 314, 315

Art.	cm	Gr.	Pz./St.	€	EAN
48					8 016604 000485



- Espositore gancho per attrezzi con manico**
- Expositor Gancho para herramientas con mango**
- Haken für Geräte mit Stiel**
- Hook display for tools with handle**

Art.	m	Pz./St.	€	EAN
75				8 016604 000751



- Espositore gancho per lance pompe**
- Expositor gancho para lanzas de bombas**
- Haken für Pumpenlanzen**
- Hook display for electric sprayer's lances**

Art.	m	Pz./St.	€	EAN
76				8 016604 000768



- Espositore barra orizzontale per gancho**
- Expositor barra horizontal para gancho**
- Horizontale Stange**
- Display horizontal bar for hook**

Art.	cm	Gr.	Pz./St.	€	EAN
42					8 016604 000423





- Espositore barra orizzontale per abbigliamento**
- Expositor barra horizontal para vestimenta**
- Horizontale Stange für Bekleidung**
- Display horizontal bar for clothing**

Art.	cm	Gr.	Pz./St.	€	EAN
82					8 016604 900822



- Monitor per espositore con gancio**
- Pantalla para expositor con gancho**
- Verkaufsständer mit Haken**
- Screen for display with hook**



Art.	m	Pz./St.	€	EAN
079				8 016604 183256



- Chiavetta USB Magma**
- Memoria USB Magma**
- Magma-USB-Stick**
- Magma USB stick**



Art.	m	Pz./St.	€	EAN
081				8 016604 181696



- Espositore a ruote**
- Expositor de ruedas**
- Verkaufsständer mit Rädern**
- Display with wheels**

Art.	m	Pz./St.	€	EAN
7	0,60 x 0,40 x h 1,90 m			8 016604 000072

* fino ad esaurimento
* hasta agotamiento
* solange der Vorrat reicht
* While supplies last



COMPONENTI COMPATIBILI PER BARRA ART. 42

COMPONENTES ADICIONALES CON LA BARRA ART. 42
KOMPATIBLE KOMPONENTEN FÜR HORIZONTALE STANGE ART. 42
COMPATIBLE COMPONENTS FOR THE HORIZONTAL BAR ITEM 42

Art.
42



- Espositore gancio per vanghe e attrezzi**
- Expositor gancho para palas y herramientas**
- Verkaufsständer Haken für Spaten und Geräte**
- Display hook for tools and spades**

Art.	cm	Gr.	Pz./St.	€	EAN
39	26,5				8 016604 000393



- Espositore gancio per forbici elettriche**
- Expositor gancho para tijeras eléctricas**
- Haken für elektrische Scheren**
- Hook display for electric shears**

Art.	m	Pz./St.	€	EAN
72				8 016604 000720



- Espositore gancio per motosega elettrica**
- Expositor gancho para motosierra eléctrica**
- Haken für elektrische Kettensäge**
- Hook display for electric chainsaw**

Art.	m	Pz./St.	€	EAN
73				8 016604 000737



- Espositore gancio per imballaggi con maniglia**
- Expositor de ganchos para embalaje con asa**
- Haken für Verpackungen mit Griff**
- Hook display for packaging with handle**

Art.	m	Pz./St.	€	EAN
74				8 016604 000744



stocker

www.stockergarden.com

268
FORBICI LÖWE
TIJERAS LÖWE
LÖWE-SCHEREN
LÖWE SHEARS

272, 288
ATTREZZI A BATTERIA
HERRAMIENTAS A BATERÍA
AKKU-WERKZEUGE
BATTERY TOOLS

**ATTREZZI A
BATTERIA
BATTERY
TOOLS**

273
FORBICI PROFESSIONALI
TIJERAS PROFESIONALES
PROFI-SCHEREN
PROFESSIONAL PRUNING SHEARS

**FORBICI
SHEARS**

275
TRONCARAMI
CORTARRAMAS
ASTSCHEREN
LOPPERS

276
TAGLIASIEPI
RECORTASETOS
HECKENSCHEREN
HEDGE SHEARS

277, 327
FORBICI AD ASTA LUNGA
TIJERAS DE MANGO LARGO
LANGARMSCHEREN
LONG HANDLED PRUNING SHEARS

278, 329
COMBISYSTEM
KOMBISYSTEM

**TRONCARAMI,
TAGLIASIEPI
LOPPERS,
HEDGE SHEARS**

280
SEGHETTI PROFESSIONALI
SERRUCHOS PROFESIONALES
PROFI-SÄGEN
PROFESSIONAL SAWS

**SEGHETTI
PRUNING
SAWS**

281, 331
POMPE MANUALI
BOMBAS MANUALES
MANUELLE DRUCKPUMPEN
MANUAL SPRAYERS

340
BRUCIA ERBACCE
QUEMADOR DE MALAS HIERBAS
UNKRAUTBRENNER
WEED-KILLER

**POMPE
MANUALI
MANUAL
SPRAYERS**

285
LANCE
LANZAS
BRAUSEN
SPRINKLER HEADS

**IRRIGAZIONE
IRRIGATION**

285
ATTREZZI
HERRAMIENTAS
GARTENWERKZEUGE
GARDEN TOOLS

**ATTREZZI
TOOLS**

285
LEGATRICI E COLTELLI
ATADORAS Y NAVAJAS
BINDEGERÄTE UND MESSER
BINDERS AND KNIVES

**LEGATRICI
BINDERS**

287
PROTEZIONE
PROTECCIÓN
ABDECKMATERIALIEN
PROTECTION

**PROTEZIONE
PROTECTION**

286, 341
ACCESSORI GIARDINO
ACCESORIOS PARA JARDÍN
GARTENZUBEHÖR
GARDEN ACCESSORIES

**ACCESSORI
ACCESSORIES**

RICAMBI

RECAMBIOS
ERSATZTEILE
SPARE PARTS

TROVA FACILMENTE IL RICAMBIO ADATTO!

Scopri la sezione "ADATTO A": collegamento immediato tra prodotti e relativi ricambi!

¡ENCUENTRA FÁCILMENTE EL RECAMBIO ADECUADO!

Descubre la sección "ADECUADO PARA": conexión inmediata entre productos y recambios correspondientes!

ERSATZTEILE FINDEN WAR NIE SO EINFACH!

Navigiere auf den Produktseiten zum Punkt „PASST ZU“ um alle für dieses Produkt geeigneten Ersatzteile zu finden.

EASILY FIND THE RIGHT SPARE PARTS

Discover the "REPLACEMENT PARTS" section: the most intuitive connection between products and spare parts!



per/para/
für/for
Art.



Forbici Tijeras Scheren

10107		LöWE Lama per forbice LöWE Hoja para tijera LöWE Klinge für Schere LöWE Blade for shears Art. 10001/B € 18,65- 	LöWE Lama per forbice LöWE Hoja para tijera LöWE Klinge für Schere LöWE Blade for shears Art. 10001 € 17,85- 
10107		LöWE Lama per forbice LöWE Hoja para tijera LöWE Klinge für Schere LöWE Blade for shears Art. 10001 € 17,85- 	LöWE Molla per forbice LöWE Muelle para tijera LöWE Spiralfeder für Schere LöWE Spring for shears Art. 1003 € 3,30- 
10107		LöWE Controlama per forbice LöWE Contra hoja para tijera LöWE Unterlage für Schere LöWE Anvil for shears Art. 10002/B € 6,25- 	LöWE Impugnatura LöWE Empuñadura LöWE Griff LöWE Handle Art. 1004/04 € 6,05- 
10107		LöWE Controlama per forbice LöWE Contra hoja para tijera LöWE Unterlage für Schere LöWE Anvil for shears Art. 10002 € 4,35- 	LöWE Impugnatura LöWE Empuñadura LöWE Griff LöWE Handle Art. 1004/07 € 6,05- 
10107		LöWE Vite per controlama LöWE Tornillo para contra hoja LöWE Schraube für Unterlage LöWE Screw for anvil Art. 10006 € 1,85- 	LöWE Bullone centrale LöWE Bulón central LöWE Zentralbolzen LöWE Central bolt Art. 1005 € 3,00- 
10107		LöWE Set ricambi LöWE Set recambios LöWE Ersatzteil-Set LöWE Spare parts set (10001, 10002, 1003, 1005, 1006) Art. 10007 € 27,55- 	LöWE Vite per controlama LöWE Tornillo para contra hoja LöWE Schraube für Gegenklinge LöWE Screw for anvil Art. 1006 € 2,00- 
1104 1105 1107 1109		LöWE Lama per forbice LöWE Hoja para tijera LöWE Klinge für Schere LöWE Blade for shears Art. 1001/BL € 17,30- 	LöWE Set ricambi LöWE Set recambios LöWE Ersatzteil-Set LöWE Spare parts set (1001, 1002, 1003, 1005, 1006) Art. 1007 € 25,95- 

per/para/
für/for
Art.

5127		LöWE Lama per forbice LöWE Hoja para tijera LöWE Klinge für Schere LöWE Blade for shears Art. 5021 € 17,20- 	LöWE Chiusura LöWE Cierre LöWE Riegel LöWE Lock Art. 1009 € 2,00- 
5104 5107 5109		LöWE Controlama per forbice LöWE Contra hoja para tijera LöWE Unterlage für Schere LöWE Anvil for shears Art. 5002 € 3,85- 	LöWE Manico girevole LöWE Mango giratorio LöWE Rollgriff LöWE Revolving handle Art. 1011 € 22,35- 
5127		LöWE Controlama per forbice LöWE Contra hoja para tijera LöWE Unterlage für Schere LöWE Anvil for shears Art. 5022 € 4,00- 	LöWE Lama per forbice LöWE Hoja para tijera LöWE Klinge für Schere LöWE Blade for shears Art. 2001/BL € 18,25- 
5104 5107 5109 5127		LöWE Molla per forbice LöWE Muelle para tijera LöWE Feder für Schere LöWE Spring for shears Art. 5003 € 3,05- 	LöWE Lama per forbice LöWE Hoja para tijera LöWE Klinge für Schere LöWE Blade for shears Art. 2001 € 17,20- 
5104 5107 5127		LöWE Impugnatura LöWE Empuñadura LöWE Griff LöWE Handle Art. 5004 € 5,05- 	LöWE Set ricambi LöWE Set recambios LöWE Ersatzteil-Set LöWE Spare parts set (1002, 1003, 1005, 1006, 2001) Art. 2007/BL € 26,05- 
5104 5107 5109 5127		LöWE Bullone centrale LöWE Bulón central LöWE Bolzen mit Mutter und Buchse LöWE Central bolt Art. 5005 € 2,35- 	LöWE Vite per regolazione impugnatura LöWE Bulón central LöWE Tornillo para regulación empuñadura LöWE Stellschraube für Griffverstellung LöWE Screw for handle Art. 2008 € 1,45- 
5104 5107 5109		LöWE Set ricambi LöWE Set recambios LöWE Ersatzteil-Set LöWE Spare parts set (5001, 5002, 5003, 5005, 5006) Art. 5007 € 24,25- 	LöWE Lama per forbice LöWE Hoja para tijera LöWE Klinge für Schere LöWE Blade for shears Art. 5001/BL € 15,70- 
5104 5107 5109 5127		LöWE Chiusura LöWE Cierre LöWE Verschluss LöWE Lock Art. 5009 € 1,90- 	LöWE Lama per forbice LöWE Hoja para tijera LöWE Klinge für Schere LöWE Blade for shears Art. 5001 € 14,95- 

per/para/
für/for
Art.





5127		LöWE Set ricambi LöWE Set recambios LöWE Ersatzteil-Set LöWE Spare parts set Art. 5027 € 26,00- 	LöWE Bullone LöWE Bulón LöWE Bolzen LöWE Bolt (6012, 6015, 6016, 6018) Art. 6010 € 10,45- 
6104 6107 6109		LöWE Lama per forbice LöWE Hoja para tijera LöWE Klinge für Schere LöWE Blade for shears Art. 6001/BL € 18,30- 	LöWE Set ricambi LöWE Set recambios LöWE Ersatzteil-Set LöWE Spare parts set (6001, 6002, 6003) Art. 6007 € 23,60- 
6104 6107 6109		LöWE Lama per forbice LöWE Hoja para tijera LöWE Klinge für Schere LöWE Blade for shears Art. 6001 € 17,20- 	LöWE Vite per regolazione impugnatura LöWE Tornillo para regulación empuñadura LöWE Stellschraube für Griffverstellung LöWE Screw for handle Art. 6008 € 1,45- 
6104 6107 6109		LöWE Controlama per forbice LöWE Contra hoja para tijera LöWE Unterlage für Schere LöWE Anvil for shears Art. 6002 € 3,75- 	LöWE Chiusura LöWE Cierre LöWE Verschluss LöWE Lock Art. 6009 € 4,60- 
6104 6107 6109 7104 7107 7109 8104 8107 9104 9107 9109		LöWE Controlama per forbice LöWE Contra hoja para tijera LöWE Unterlage für Schere LöWE Anvil for shears Art. 6003 € 3,00- 	LöWE Bullone LöWE Bulón LöWE Bolzen LöWE Bolt Art. 6012 € 1,95- 
6104 7104 8104 9104		LöWE Impugnatura LöWE Empuñadura LöWE Griff LöWE Handle Art. 6004/04 € 7,30- 	LöWE Rondella centrale LöWE Arandela central LöWE Distanzscheibe LöWE Central washer Ø 25 mm Art. 6015 € 1,50- 
6109 7109 8109 9109		LöWE Manico per forbice LöWE Mango para tijera LöWE Griff für Schere LöWE Handle for shears Art. 6013 € 45,80- 	LöWE Perno centrale LöWE Perno central LöWE Lagerbolzen mit Kontermutter LöWE Central pin Art. 6016 € 6,25- 
6107 7107 8107 9107		LöWE Impugnatura LöWE Empuñadura LöWE Griff LöWE Handle Art. 6004/07 € 7,30- 	LöWE Vite per lama LöWE Tornillo para hoja LöWE Schraubenmutter für Klinge LöWE Screw for blade Art. 6018 € 1,85- 

per/para/ für/for Art.		
6104 6107 6109 7104 7107 7109 8104 8107 8109 9104 9107 9109		LÖWE Vite per manico LÖWE Tornillo para mango LÖWE Schrauben für Griff LÖWE Screw for handle Art. 7777 € 1,45- 8 016604 077777
7104 7107 7109		LÖWE Lama per forbice LÖWE Hoja para tijera LÖWE Klinge für Schere LÖWE Blade for shears Art. 7001/BL € 18,40- 4 033119 001343
7104 7107 7109		LÖWE Lama per forbice LÖWE Hojas para tijera LÖWE Klängen für Schere LÖWE Blades for shears Art. 7001 € 17,45- 4 033119 001350
7104 7107 7109		LÖWE Controlama per forbice LÖWE Contra hoja para tijera LÖWE Unterlage für Schere LÖWE Anvil for shears Art. 7002 € 3,65- 4 033119 001862
7104 7107 7109		LÖWE Controlama per forbice LÖWE Contra hoja para tijera LÖWE Unterlage für Schere LÖWE Anvil for shears Art. 7002 € 3,65- 4 033119 001862
7104 7107 7109		LÖWE Set ricambi LÖWE Set recambios LÖWE Ersatzteil-Set LÖWE Spare parts set (7001, 7002, 6003) Art. 7007 € 24,15- 4 033119 002678
8104 8107 8109		LÖWE Lama per forbice LÖWE Hoja para tijera LÖWE Klinge für Schere LÖWE Blade for shears Art. 8001B € 20,10- 4 033119 001299
8104 8107 8109		LÖWE Lama per forbice LÖWE Hojas para tijera LÖWE Klängen für Schere LÖWE Blades for shears Art. 8001 € 18,90- 4 033119 001305
8104 8107 8109		LÖWE Controlama per forbice LÖWE Contra hoja para tijera LÖWE Unterlage für Schere LÖWE Anvil for shears Art. 8002 € 3,75- 4 033119 001770

per/para/ für/for Art.		
8104 8107 8109		LÖWE Set ricambi LÖWE Set recambios LÖWE Ersatzteil-Set LÖWE Spare parts set (6003, 8001) Art. 8007 € 25,70- 4 033119 002654
9104 9107 9109		LÖWE Lama per forbice LÖWE Hoja para tijera LÖWE Klinge für Schere LÖWE Blade for shears Art. 9001/BL € 21,80- 4 033119 001244
9104 9107 9109		LÖWE Lama per forbice LÖWE Hojas para tijera LÖWE Klängen für Schere LÖWE Blades for shears Art. 9001 € 20,80- 4 033119 001060
9104 9107 9109		LÖWE Controlama per forbice LÖWE Contra hoja para tijera LÖWE Unterlage für Schere LÖWE Anvil for shears Art. 9002 € 29,20- 4 033119 001534
9104 9107 9109		LÖWE Set ricambi LÖWE Set recambios LÖWE Ersatzteil-Set LÖWE Spare parts set (6003, 9001) Art. 9007 € 24,85- 4 033119 002579
9104 9107 9109		LÖWE Ammortizzatore LÖWE Amortiguador LÖWE Pufferfeder LÖWE Shock absorber Art. 9008 € 3,30- 4 033119 002111
11104 11107 11109		LÖWE Lama per forbice LÖWE Hoja para tijera LÖWE Klinge für Schere LÖWE Blade for shears Art. 11001 € 25,30- 4 033119 001145
11104 11107 11109		LÖWE Controlama per forbice LÖWE Contra hoja para tijera LÖWE Unterlage für Schere LÖWE Anvil for shears Art. 11002 € 24,60- 4 033119 001640

per/para/ für/for Art.		
11104 11107 11109 12104 12109		LÖWE Molla per forbice LÖWE Muelle para tijera LÖWE Spiralfeder für Schere LÖWE Spring for shears Art. 11003 € 1,40- 4 033119 002234
11104 11109		LÖWE Impugnatura LÖWE Empuñadura LÖWE Griffe LÖWE Handle Art. 11004 /04 € 20,50- 4 033119 002241
11107		LÖWE Impugnatura LÖWE Empuñadura LÖWE Griffe LÖWE Handle Art. 11004 /07 € 20,50- 4 033119 004108
11104 11107 11109 12104 12109		LÖWE Bullone e madrevite LÖWE Bulón y tuercas LÖWE Bolzen und Schraubenmutter LÖWE Bolt and nut Art. 11005 € 5,65- 4 033119 002258
11104 11107 11109 12104 12109		LÖWE Vite e madrevite LÖWE Tornillos y tuercas LÖWE Schrauben und Schraubenmutter LÖWE Screws and nuts Art. 11006 € 4,00- 4 033119 002265
11104 11107 11109		LÖWE Set ricambi LÖWE Set recambios LÖWE Ersatzteil-Set LÖWE Spare parts set (11001, 11003, 11005, 11006 (2x), 11008) Art. 11007 € 34,35- 4 033119 002586
11104 11107 11109 12104 12109		LÖWE Ammortizzatore LÖWE Amortiguador LÖWE Puffer LÖWE Shock absorber Art. 11008 € 1,20- 4 033119 002272
11104 11107 11109 12104 12109		LÖWE Chiusura LÖWE Cierre LÖWE Riegel LÖWE Lock Art. 11009 € 2,25- 4 033119 002289

per/para/ für/for Art.		
12104 12109		LÖWE Lama per forbice LÖWE Hoja para tijera LÖWE Klinge für Schere LÖWE Blade for shears Art. 12001 € 23,85- 4 033119 001152
12104 12109		LÖWE Controlama per forbice LÖWE Contra hoja para tijera LÖWE Gegenklinge für Schere LÖWE Anvil for shears Art. 12002 € 23,30- 4 033119 001657
12104 12109		LÖWE Impugnatura LÖWE Empuñadura LÖWE Griffe LÖWE Handle Art. 12004 € 21,55- 4 033119 002296
12104 12109		LÖWE Set ricambi LÖWE Set recambios LÖWE Ersatzteil-Set LÖWE Spare parts set (11003, 11005, 11006 (2x), 11008, 12001) Art. 12007 € 34,00- 4 033119 002593
14104 15104 15107 15114		LÖWE Lama per forbice LÖWE Hoja para tijera LÖWE Klinge für Schere LÖWE Blade for shears Art. 14001 € 21,55- 4 033119 001404
14104 15104 15114		LÖWE Impugnatura LÖWE Empuñadura LÖWE Griffe LÖWE Handle Art. 14004/04 € 5,65- 4 033119 002494
14107 15107		LÖWE Impugnatura LÖWE Empuñadura LÖWE Griffe LÖWE Handle Art. 14004/07 € 5,65- 4 033119 002500
14104 14107 15104 15107 15114		LÖWE Bullone centrale LÖWE Bulón central LÖWE Zentralbolzen LÖWE Central bolt Art. 14005 € 5,05- 4 033119 004009

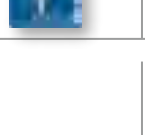
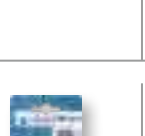
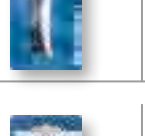
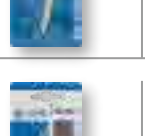
per/para/ für/for Art.		
14104 14107		LÖWE Set ricambi LÖWE Set recambios LÖWE Ersatzteil-Set LÖWE Spare parts set (14001, 14003, 14005, 14008) Art. 14007 € 25,80- 4 033119 002685
14104 14107 15104 15107 15114		LÖWE Ammortizzatore LÖWE Amortiguador LÖWE Puffer LÖWE Shock absorber Art. 14008 € 3,05- 4 033119 004016
14104 14107 15104 15107 15114		LÖWE Chiusura LÖWE Cierre LÖWE Riegel LÖWE Lock Art. 14009 € 1,45- 4 033119 004023
15104 15107 15114		LÖWE Lama per forbice LÖWE Hoja para tijera LÖWE Klinge für Schere LÖWE Blade for shears Art. 15001 € 21,40- 4 033119 001411
15104 15107 15114		LÖWE Controlama per forbice LÖWE Contra hoja para tijera LÖWE Unterlage für Schere LÖWE Anvil for shears Art. 15002 € 3,85- 4 033119 001916
15104 15107 15114		LÖWE Set ricambi LÖWE Set recambios LÖWE Ersatzteil-Set LÖWE Spare parts set (15001, 15002, 14003, 14005, 14008) Art. 15007 € 29,70- 4 033119 002692
15104 15107 15114		LÖWE Attacco per controlama LÖWE Conexión para contra hoja LÖWE Unterlagenhebel LÖWE Coupling for anvil Art. 15013 € 13,60- 4 033119 004030
14104 14107		LÖWE Controlama per forbice LÖWE Contrahoja para tijera LÖWE Gegenklinge für Schere LÖWE Counterblade for shears Art. 14002 € 16,70- 4 033119 001909

per/para/ für/for Art.		
31040 31050 31060		LÖWE Lama per troncarami LÖWE Hoja para cortarramas LÖWE Klinge für Astscheren LÖWE Blade for lopper Art. 31001 € 28,55- 4 033119 310018
31040 31050 31060		LÖWE Controlama per troncarami LÖWE Contra hoja para cortarramas LÖWE Unterlage für Astscheren LÖWE Anvil for lopper Art. 31002 € 33,95- 4 033119 310025
31040 31050 31060		LÖWE Set bulloni LÖWE Set bulones LÖWE Bolzen-Set LÖWE Bolts set Art. 30005 € 14,85- 4 033119 300057
31040 31050 31060		LÖWE Tappo LÖWE Tapón LÖWE Anschlagpuffer LÖWE Cap Art. 31008 € 11,25- 4 033119 310087
31040 31050 31060		LÖWE Vite per manico LÖWE Tornillo para mango LÖWE Schrauben für Griff LÖWE Screw for handle Art. 30012 € 12,85- 4 033119 300125
31040		LÖWE Set manici LÖWE Set mangos LÖWE Set Griffrohre LÖWE Handles set Art. 30011/40 € 29,65- 4 033119 300200
31050		LÖWE Set manici LÖWE Set mangos LÖWE Set Griffrohre LÖWE Handles set Art. 30011/50 € 33,25- 4 033119 300217



Troncarami Corta-ramas Astscheren Loppers

per/para/ für/for Art.		LÖWE Set manici LÖWE Set mangos LÖWE Set Griffrohre LÖWE Handles set Art. 30011/60 € 38,40-	per/para/ für/for Art.		LÖWE Bullone e rondella LÖWE Bulón y arandela LÖWE Bolzen und Mutter LÖWE Bolt and washer Art. 70005 € 17,55-
31060			69050 69065 69080 69100 69150		LÖWE Lama per troncaremi LÖWE Hoja para cortarramas LÖWE Klinge für Astscheren LÖWE Blade for lopper Art. 69001 € 43,20-
69050 69065 69080 69100 69150			69050 69065 69080 69100 69150		LÖWE Controlama per troncaremi LÖWE Contra hoja para cortarramas LÖWE Unterlage für Astscheren LÖWE Anvil for lopper Art. 69002 € 16,40-
69050 69065 69080 69100 69150			70050 70065 70080 70100		LÖWE Attacco per controlama LÖWE Conexión para contra hoja LÖWE Unterlagenhebel LÖWE Coupling for anvil Art. 69013 € 35,80-
70050 70065 70080 70100			71050 71065 71080 71100		LÖWE Lama per troncaremi LÖWE Hoja para cortarramas LÖWE Klinge für Astscheren LÖWE Blade for lopper Art. 70001 € 40,10-
70050 70065 70080 70100			71050 71065 71080 71100		LÖWE Controlama per troncaremi LÖWE Contra hoja para cortarramas LÖWE Gegenklinge für Astscheren LÖWE Anvil for lopper Art. 70002 € 14,20-
69050 69065 69080 69100 70050 70065 70080 70100 71050 71065 71080 71100			71050 71065 71080 71100		LÖWE Impugnatura LÖWE Empuñadura LÖWE Griff LÖWE Handle Art. 70004 € 13,50-
69100 70100					

per/para/ für/for Art.		Lame per forbici Hojas para tijera Klingen für Schere Blades for shears Art. L-350 € 13,00-	per/para/ für/for Art.		Lama per forbici Hoja para tijera Klinge für Schere Blade for shears Art. L-376 € 31,30-
350			376 377		
322 362			352		
323 363			362 322		
335 341			363 323		
342			364		
343 368			364		
344			367		
345			371		

Stocker Forbici a batteria Tijeras eléctricas Elektrische Baumscheren Battery shears

310
311
314

Caricabatteria triplo
Cargador triple
Dreifach-Ladegerät
Triple battery charger
Art. 310/16
€ 23,30-

310
311
313
314

Kit aggiornamento firmware
Kit Firmware Aktualisierung
Kit actualización firmware
Firmware updating kit
Art. 310/17
€ 53,70-

9082
9083

Ugello di precisione
Boquilla de precisión
Präzisionsdüse
Precision nozzle
Art. 9084
€ 2,35-

312

Kit aggiornamento firmware
Kit Firmware Aktualisierung
Kit actualización firmware
Firmware updating kit
Art. 312/17
€ 9,00-

Stocker Lame forbici Hojas de tijeras Scheren-Klingen Shear blades

Lama per forbici
Hoja para tijera
Klinge für Schere
Blade for shears
Art. L-322
€ 11,70-

Lama per forbici
Hoja para tijera
Klinge für Schere
Blade for shears
Art. L-323
€ 12,80-

Lama per forbici
Hojas para tijera
Klingen für Schere
Blades for shears
Art. L-341
€ 14,80-

Lama per forbici
Hojas para tijera
Klingen für Schere
Blades for shears
Art. L-342
€ 13,90-

Lame per forbici
Hojas para tijera
Klingen für Schere
Blades for shears
Art. L-343
€ 13,90-

Lame per forbici
Hojas para tijera
Klingen für Schere
Blades for shears
Art. L-344
€ 13,00-

Laccio
Lazo
Schlinge
Lace
Art. L-345
€ 0,40-

Lame per forbici
Hojas para tijera
Klingen für Schere
Blades for shears
Art. L-350
€ 13,00-

Lame per forbici
Hojas para tijera
Klingen für Schere
Blades for shears
Art. L-352
€ 14,50-

Lama per forbici
Hoja para tijera
Klinge für Schere
Blade for shears
Art. L-362
€ 11,90-

Lama per forbici
Hoja para tijera
Klinge für Schere
Blade for shears
Art. L-363
€ 12,80-

Lama per forbici
Hoja para tijera
Klinge für Schere
Blades for shears
Art. L-364
€ 12,80-

Controlama per forbici
Contra hoja para tijeras
Unterlage für Schere
Anvil for shears
Art. C-364
€ 5,90-

Lame per forbici
Hojas para tijera
Klingen für Schere
Blades for shears
Art. L-367
€ 14,60-

Lame per forbici
Hojas para tijera
Klingen für Schere
Blades for shears
Art. L-371
€ 14,80-

Set ricambi
Set recambios
Ersatzteil-Set
Spare parts set
Art. R-7244
€ 10,80-

Set ricambi
Set recambios
Ersatzteil-Set
Spare parts set
Art. B-342
€ 1,90-

Set ricambi
Set recambios
Ersatzteil-Set
Spare parts set
Art. B-343
€ 8,10-

Kit viti e chiusura
Kit tornillos y cierre
Kit Schrauben und Verschluss
Screws and locking kit clip
Art. B-352
€ 8,10-



Kit viti e chiusura
Kit tornillos y cierre
Kit Schrauben und Verschluss
Screws and locking clip kit
Art. A-342
€ 8,10-

Kit viti e chiusura
Kit tornillos y cierre
Kit Schrauben und Verschluss
Screws and locking clip kit
Art. A-350
€ 8,10-

per/para/ für/for Art. ↓		Kit bulloni Kit bulones Bolzen-Kit Bolts set Art. B-341 € 4,50-	per/para/ für/for Art. ↓		Ammortizzatore Amortiguador Anschlagpuffer Shock absorber Art. P-364 € 5,80-	per/para/ für/for Art. ↓		Piastrina Placa Scheibe Plate Art. P-376 € 1,65-	per/para/ für/for Art. ↓		Molla per forbice Muelle para tijera Feder für Schere Spring for shears Art. R-334 € 0,70-	per/para/ für/for Art. ↓		Molla per forbice Muella para tijera Feder für Schere Spring for shears Art. M-362 € 6,50-	per/para/ für/for Art. ↓		Molla per forbice Muella para tijera Feder für Schere Spring for shears Art. R-34520 € 0,60-			
335 341 367		8 016604 803413	364		8 016604 703645	376 377		8 016604 403767	334		8 016604 903342	362 363 364		8 016604 703621	34520 34525 34620 34625		8 016604 345210			
362 363 364		Kit bulloni Kit bulones Bolzen-Kit Bolts set Art. B-362 € 9,10-	342 343 350 352 368		Chiusura Cierre Riegel Lock Art. B-350 € 0,40-	378 379		Piastrina Placa Scheibe Plate Art. P-378 € 1,65-	339 349		Molla per forbice Muelle para tijera Feder für Schere Spring for shears Art. R-339 € 0,60-	340 371		Molla per forbice Muella para tijera Feder für Schere Spring for shears Art. R-371 € 1,40-	Stocker Troncarami Corta-ramas Astscheren Loppers					
	Kit bulloni Kit bulones Bolzen-Kit Bolts set Art. B-362 € 9,10-	8 016604 803628		Chiusura Cierre Riegel Lock Art. B-350 € 0,40-	8 016604 803505		Piastrina Placa Scheibe Plate Art. P-378 € 1,65-	8 016604 703782		Molla per forbice Muelle para tijera Feder für Schere Spring for shears Art. R-339 € 0,60-	8 016604 903397		Molla per forbice Muella para tijera Feder für Schere Spring for shears Art. R-371 € 1,40-	8 016604 803710						
335		Manico con controlama per forbice Mango con contra hoja para tijera Griff mit Unterlage für Schere Handle with anvil for shears Art. C-335 € 11,00-	362 363 364		Chiusura Cierre Riegel Lock Art. B-363 € 4,90-	376 377		Set ricambi Set recambios Ersatzteil-Set Spare parts set Art. S-376 € 5,80-	340		Molla per forbice Muelle para tijera Feder für Schere Spring for shears Art. R-340 € 1,30-	372 373 392 393		Molla per forbice Muella para tijera Feder für Schere Spring for shears Art. R-372 € 1,00-	72080 72100		Lama per troncarami Hoja para cortarramas Klinge für Astschere Blade for lopper Art. R-72080 € 29,60-			
	Manico con controlama per forbice Mango con contra hoja para tijera Griff mit Unterlage für Schere Handle with anvil for shears Art. C-335 € 11,00-	8 016604 903557		Chiusura Cierre Riegel Lock Art. B-363 € 4,90-	8 016604 803635		Set ricambi Set recambios Ersatzteil-Set Spare parts set Art. S-376 € 5,80-	8 016604 503764		Molla per forbice Muelle para tijera Feder für Schere Spring for shears Art. R-340 € 1,30-	8 016604 903403		Molla per forbice Muella para tijera Feder für Schere Spring for shears Art. R-372 € 1,00-	8 016604 903724		Lama per troncarami Hoja para cortarramas Klinge für Astschere Blade for lopper Art. R-72080 € 29,60-				
341		Manico con controlama per forbice Mango con contra hoja para tijera Griff mit Unterlage für Schere Handle with anvil for shears Art. C-341 € 11,00-	342		Pin di fissaggio per lama Pin de fijaje para hoja Fixier-Stift für Klinge Fixing pin for blade Art. P-342 € 0,20-	378 379		Set ricambi Set recambios Ersatzteil-Set Spare parts set Art. S-378 € 5,80-	335 341 342 343 344 350 352 367 368		Molla per forbice Muelle para tijera Feder für Schere Spring for shears Art. R-342 € 2,20-	376 377 378 379		Molla per forbice Muella para tijera Feder für Schere Spring for shears Art. R-376 € 2,75-	72081 72101		Lama per troncarami Hoja para cortarramas Klinge für Astschere Blade for lopper Art. R-72081 € 37,35-			
	Manico con controlama per forbice Mango con contra hoja para tijera Griff mit Unterlage für Schere Handle with anvil for shears Art. C-341 € 11,00-	8 016604 703416		Pin di fissaggio per lama Pin de fijaje para hoja Fixier-Stift für Klinge Fixing pin for blade Art. P-342 € 0,20-	8 016604 703423		Set ricambi Set recambios Ersatzteil-Set Spare parts set Art. S-378 € 5,80-	8 016604 803789		Molla per forbice Muelle para tijera Feder für Schere Spring for shears Art. R-342 € 2,20-	8 016604 803420		Molla per forbice Muella para tijera Feder für Schere Spring for shears Art. R-376 € 2,75-	8 016604 703768		Lama per troncarami Hoja para cortarramas Klinge für Astschere Blade for lopper Art. R-72081 € 37,35-				
362 363 364		Impugnatura Empuñadura Griff Handle Art. H-363 € 11,00-	352		Ammortizzatore Amortiguador Anschlagpuffer Shock absorber Art. R-352 € 0,20-	392 393		Ammortizzatore Amortiguador Anschlagpuffer Shock absorber Art. R-392 € 0,30-	345 346 374		Molla per forbice Muelle para tijera Feder für Schere Spring for shears Art. R-345 € 0,60-	380 381		Molla per forbice Muella para tijera Feder für Schere Spring for shears Art. R-380 € 2,40-	72080 72100		Controlama per troncarami Contra hoja para cortarramas Unterlage für Astscheren Anvil for lopper Art. C-72080 € 18,90-			
	Impugnatura Empuñadura Griff Handle Art. H-363 € 11,00-	8 016604 903632		Ammortizzatore Amortiguador Anschlagpuffer Shock absorber Art. R-352 € 0,20-	8 016604 703508		Ammortizzatore Amortiguador Anschlagpuffer Shock absorber Art. R-392 € 0,30-	8 016604 903922		Molla per forbice Muelle para tijera Feder für Schere Spring for shears Art. R-345 € 0,60-	8 016604 903458		Molla per forbice Muella para tijera Feder für Schere Spring for shears Art. R-380 € 2,40-	8 016604 993800		Controlama per troncarami Contra hoja para cortarramas Unterlage für Astscheren Anvil for lopper Art. C-72080 € 18,90-				
362 363 364		Impugnatura Empuñadura Griff Handle Art. H-363 € 11,00-	368 343		Ammortizzatore Amortiguador Anschlagpuffer Shock absorber Art. P-368 € 0,20-	392 393		Chiusura Cierre Verschluss Lock Art. R-393 € 0,40-	347 358		Molla per forbice Muelle para tijera Feder für Schere Spring for shears Art. R-347 € 0,60-	382 384 386		Molla per forbice Muella para tijera Feder für Schere Spring for shears Art. R-382 € 1,70-	72081 72101		Controlama per troncarami Contra hoja para cortarramas Unterlage für Astscheren Anvil for lopper Art. C-72081 € 21,80-			
	Impugnatura Empuñadura Griff Handle Art. H-363 € 11,00-	8 016604 903632		Ammortizzatore Amortiguador Anschlagpuffer Shock absorber Art. P-368 € 0,20-	8 016604 703522		Chiusura Cierre Verschluss Lock Art. R-393 € 0,40-	8 016604 903939		Molla per forbice Muelle para tijera Feder für Schere Spring for shears Art. R-347 € 0,60-	8 016604 903472		Molla per forbice Muella para tijera Feder für Schere Spring for shears Art. R-382 € 1,70-	8 016604 903823		Controlama per troncarami Contra hoja para cortarramas Unterlage für Astscheren Anvil for lopper Art. C-72081 € 21,80-				
367		Manico con controlama per forbice Mango con contra hoja para tijera Griff mit Unterlage für Schere Handle with anvil for shears Art. C-367 € 11,00-	376 378		Impugnatura in alluminio Empuñadura de aluminio Aluminium-Griff Aluminium handles Art. M-376 € 15,55-	Stocker Molle forbici Muelles tijeras Scheren-Federn Shear springs		392 393		Chiusura Cierre Verschluss Lock Art. R-393 € 0,40-	348		Molla per forbice Muelle para tijera Feder für Schere Spring for shears Art. R-348 € 0,70-	3518 3520 3522 3525 3522 35724		Molla per forbice Muella para tijera Feder für Schere Spring for shears Art. R-35522 € 0,60-	530 2092 7237 7238		Lama e controlama per troncarami Hoja y contra hoja para cortarramas Klinge und Unterlage für Astscheren Blade and anvil for lopper Art. B-2092 € 26,40-	
	Manico con controlama per forbice Mango con contra hoja para tijera Griff mit Unterlage für Schere Handle with anvil for shears Art. C-367 € 11,00-	8 016604 703676		Impugnatura in alluminio Empuñadura de aluminio Aluminium-Griff Aluminium handles Art. M-376 € 15,55-	8 016604 903762	Stocker Molle forbici Muelles tijeras Scheren-Federn Shear springs			Chiusura Cierre Verschluss Lock Art. R-393 € 0,40-	8 016604 903939		Molla per forbice Muelle para tijera Feder für Schere Spring for shears Art. R-348 € 0,70-	8 016604 903489		Molla per forbice Muella para tijera Feder für Schere Spring for shears Art. R-35522 € 0,60-	8 016604 355233		Lama e controlama per troncarami Hoja y contra hoja para cortarramas Klinge und Unterlage für Astscheren Blade and anvil for lopper Art. B-2092 € 26,40-		
342 343 350 352 368		Ammortizzatore Amortiguador Anschlagpuffer Shock absorber Art. P-343 € 0,20-	377 379		Impugnatura in alluminio Empuñadura de aluminio Aluminium-Griff Aluminium handles Art. M-377 € 15,55-	Stocker Molle forbici Muelles tijeras Scheren-Federn Shear springs		392 393		Chiusura Cierre Verschluss Lock Art. R-393 € 0,40-	349		Molla per forbice Muelle para tijera Feder für Schere Spring for shears Art. R-349 € 0,80-	35620 35625		Molla per forbice Muella para tijera Feder für Schere Spring for shears Art. R-35625 € 0,60-	530 2092 7237 7238		Lama per troncarami Hoja para cortarramas Klinge für Astschere Blade for lopper Art. R-2092 € 19,10-	
	Ammortizzatore Amortiguador Anschlagpuffer Shock absorber Art. P-343 € 0,20-	8 016604 703430		Impugnatura in alluminio Empuñadura de aluminio Aluminium-Griff Aluminium handles Art. M-377 € 15,55-	8 016604 903779	Stocker Molle forbici Muelles tijeras Scheren-Federn Shear springs			Chiusura Cierre Verschluss Lock Art. R-393 € 0,40-	8 016604 903939		Molla per forbice Muelle para tijera Feder für Schere Spring for shears Art. R-349 € 0,80-	8 016604 903496		Molla per forbice Muella para tijera Feder für Schere Spring for shears Art. R-35625 € 0,60-	8 016604 356261		Lama per troncarami Hoja para cortarramas Klinge für Astschere Blade for lopper Art. R-2092 € 19,10-		
362 363		Ammortizzatore Amortiguador Anschlagpuffer Shock absorber Art. P-362 € 5,50-	376 377 378 379		Bullone centrale Bulón central Zentralbolzen Central bolt Art. B-376 € 6,60-	332 333		Molla per forbice Muelle para tijera Feder für Schere Spring for shears Art. R-332 € 0,70-	362 363		Molla per forbice Muelle para tijera Feder für Schere Spring for shears Art. R-332 € 0,70-	362 363		Molla per forbice Muella para tijera Feder für Schere Spring for shears Art. R-332 € 0,70-	362 363		Molla per forbice Muella para tijera Feder für Schere Spring for shears Art. R-332 € 0,70-	8 016604 903328		Lama per troncarami Hoja para cortarramas Klinge für Astschere Blade for lopper Art. R-2092 € 19,10-
	Ammortizzatore Amortiguador Anschlagpuffer Shock absorber Art. P-362 € 5,50-	8 016604 903625		Bullone centrale Bulón central Zentralbolzen Central bolt Art. B-376 € 6,60-	8 016604 603761		Molla per forbice Muelle para tijera Feder für Schere Spring for shears Art. R-332 € 0,70-	8 016604 903328		Molla per forbice Muelle para tijera Feder für Schere Spring for shears Art. R-332 € 0,70-	8 016604 903328		Molla per forbice Muella para tijera Feder für Schere Spring for shears Art. R-332 € 0,70-	8 016604 903328		Molla per forbice Muella para tijera Feder für Schere Spring for shears Art. R-332 € 0,70-	8 016604 903328		Lama per troncarami Hoja para cortarramas Klinge für Astschere Blade for lopper Art. R-2092 € 19,10-	

per/para/ für/for Art.	530 2092 7237 7238		Controlama per troncaremi Contrahoja para cortarramas Unterlage für Astscheren Anvil for lopper	Art. C-2092 € 12,10-	8 016604 720925
per/para/ für/for Art.	72080 72081 72100 72101		Kit bulloni Kit bulones Bolzen-Kit Bolts set	Art. B-72080 € 22,20-	8 016604 720833
per/para/ für/for Art.	2092 2094 7242		Tappo Tapón Verschluss Cap	Art. M-2094 € 7,90-	8 016604 820946
per/para/ für/for Art.	7230		Controlama per troncaremi Contrahoja para cortarramas Unterlage für Astscheren Anvil for lopper	Art. C-7230 € 8,00-	8 016604 972300
per/para/ für/for Art.	7242		Kit bulloni Kit bulones Bolzen-Kit Bolts set	Art. B-7242 € 6,10-	8 016604 872426
per/para/ für/for Art.	2092 2094 7242		Manico per troncaremi Mango para cortarramas Griff für Astscheren Handle for loppers	Art. M-2092 € 31,40-	8 016604 620928
per/para/ für/for Art.	2094 7236		Lama per troncaremi Hoja para cortarramas Klinge für Astschere Blade for lopper	Art. R-7236 € 19,10-	8 016604 972362
per/para/ für/for Art.	530 2092 2094 7236 7237 7238		Kit bulloni Kit bulones Bolzen-Kit Bolts set	Art. B-7236 € 7,70-	8 016604 972379
per/para/ für/for Art.	7242		Molla per troncaremi Muelle para cortarramas Feder für Astscheren Spring for lopper	Art. M-7242 € 2,80-	8 016604 672422
Stocker Tagliasiepi Corta-setos Heckenscheren Hedge shears					
per/para/ für/for Art.	7242		Controlama per troncaremi Contra hoja para cortarramas Unterlage für Astscheren Anvil for lopper	Art. C-7242 € 15,10-	8 016604 972447
per/para/ für/for Art.	7248 7250 7252		Kit bulloni Kit bulones Bolzen-Kit Bolts set	Art. B-7252 € 8,70-	8 016604 772528
per/para/ für/for Art.	7248 7250 7252		Tappo Tapón Verschluss Cap	Art. G-7252 € 12,30-	8 016604 672521
per/para/ für/for Art.	7248 7250 7252		Lama per troncaremi Hoja para cortarramas Klinge für Astschere Blade for lopper	Art. R-7252 € 19,20-	8 016604 972522
per/para/ für/for Art.	7248 7250 7252		Molla per troncaremi Muelle para recortasetos Feder für Heckenscheren Spring for hedge shears	Art. R-2002 € 24,00-	8 016604 820229
per/para/ für/for Art.	7248 7250 7252		Controlama per troncaremi Contra hoja para cortarramas Unterlage für Astscheren Anvil for lopper	Art. C-7252 € 25,40-	8 016604 872525
per/para/ für/for Art.	7248 7250 7252		Ammortizzatore Amortiguador Anschlagpuffer Shock absorber	Art. P-7252 € 4,20-	8 016604 572524
per/para/ für/for Art.	7230		Set viti Set tornillos Schrauben-Set Screws set	Art. B-7230 € 10,50-	8 016604 872303
per/para/ für/for Art.	2090 2092 2094 7242		Fermo bloccante Bloqueo Stopper Stopper	Art. B-2094 € 10,50-	8 016604 920943
per/para/ für/for Art.	2022 2094 7242		Bullone centrale Bulón central Zentralbolzen Central bolt	Art. B-2023 € 9,40-	8 016604 920233

per/para/ für/for Art.	2022 2010		Kit bulloni Kit bulones Bolzen-Kit Bolts set	Art. B-2022 € 6,20-	8 016604 920226
per/para/ für/for Art.	2020		Kit bulloni Kit bulones Bolzen-Kit Bolts set	Art. B-2020 € 4,00-	8 016604 200212
per/para/ für/for Art.	2039 2025		Kit bulloni Kit bulones Kit Bolzen Bolts set	Art. R-2039 € 4,80-	8 016604 820397
per/para/ für/for Art.	2090		Kit bulloni Kit bulones Kit Bolzen Bolts set	Art. R-2090 € 5,80-	8 016604 920905
per/para/ für/for Art.	2090		Ammortizzatore Amortiguador Anschlagpuffer Shock absorber	Art. P-2090 € 4,20-	8 016604 620904
per/para/ für/for Art.	2020		Molla per tagliasiepi Muelle para recortasetos Feder für Heckenscheren Spring for hedge shears	Art. R-20020 € 4,10-	8 016604 200229

per/para/ für/for Art.	Stocker Forbici erba Tijeras césped Grasschere Grass shears				
per/para/ für/for Art.	2035		Molla per maniglia Muelle para manija Feder für Griff Spring for handle	Art. R-2035 € 2,00-	8 016604 920356
per/para/ für/for Art.	2035		Molla per lama Muelle para hoja Feder für Schere Spring for blade	Art. M-2035 € 2,50-	8 016604 820359

per/para/ für/for Art.	Stocker Forbici ad asta lunga Tijeras de mango largo Langarm-Scheren Long handled pruning shears				
per/para/ für/for Art.	500 501 502 503 504 505 508 509		Lama per forbice Hoja para tijera Klinge für Schere Blade for shears	Art. L-500 € 24,90-	8 016604 905001
per/para/ für/for Art.	510		Lama per forbice Hoja para tijera Klinge für Schere Blade for shears	Art. L-510 € 25,40-	8 016604 805103
per/para/ für/for Art.	600 601		Lama per forbice Hoja para tijera Klinge für Schere Blade for shears	Art. L-600 € 25,40-	8 016604 806001
per/para/ für/for Art.	603		Lama per forbice Hoja para tijera Klinge für Schere Blade for shears	Art. B-603 € 25,40-	8 016604 606038
per/para/ für/for Art.	603 604		Lama per forbice Hoja para tijera Klinge für Schere Blade for shears	Art. L-604 € 25,40-	8 016604 806049
per/para/ für/for Art.	500 502 503 504 508 509		Set lama e controlama per forbice Set hoja y contra hoja para tijera Set Klinge und Unterlage für Schere Blade and anvil for shears	Art. A-509 € 31,70-	8 016604 805097
per/para/ für/for Art.	510		Set lama e controlama per forbice Set hoja y contra hoja para tijera Set Klinge und Unterlage für Schere Blade and anvil for shears	Art. A-510 € 24,60-	8 016604 905100

per/para/ für/for Art.		
601 603		Set lama e controlama per forbice Contra hoja y contra hoja para tijera Set Klinge und Unterlage Blade and anvil for shears Art. R-601 € 31,10-
510		Controlama in plastica Contra hoja de plástico Unterlage aus Plastik Anvil for shears Art. R-510 € 2,60-
500 502 503 504 505 508 509 510 600 601 603 604		Molla per forbice Muelle para tijera Feder für Schere Spring for shears Art. M-509 € 5,60-
603 604		Testina orientabile Cabezal orientable Beweglicher Scherenkopf Adjustable cutting-head Art. R-603 € 13,70-
502 503 504 505 508 509 510 600 603 604		Vite per fissaggio testa Tornillo para fijar la cabeza Fixierschraube für Schneidkopf Screw for fixing pruner head Art. V-603 € 2,00-
500 502 503 504 505 508 509 510 600 601 603 604		Manico per forbice Mango para tijera Griff für Schere Handle for shears Art. M-510 € 16,30-
500 502 503 504 505 508 509 510 600 601 603 604		Vite Tornillo Schraube Screw Art. B-601 € 1,40-

per/para/ für/for Art.		
502	Art. F-502	€ 14,40-
503	Art. F-503	€ 15,00-
504	Art. F-504	€ 15,00-
505	Art. F-505	€ 15,00-
506	Art. F-506	€ 10,50-
507	Art. F-507	€ 10,80-
508	Art. F-508	€ 17,30-
509	Art. F-509	€ 19,20-
510	Art. F-510	€ 19,20-
601	Art. F-601	€ 14,40-
603	Art. F-603	€ 16,30-
604	Art. F-604	€ 22,20-
506 507		Lama per forbice Hoja para tijera Klinge für Schere Blade for shears Art. L-506 € 24,70-
506 507		Molla per forbice Muelle para tijera Feder für Schere Spring for shears Art. S-506 € 5,40-

per/para/ für/for Art.		
Stocker Combisystem Kombisystem Combisystem		
531		Manico ultima uscita (S) Mango última salida (S) Griff letzter Auszug (S) Upper pole (S) Art. S531 € 24,20-
532		Manico ultima uscita (S) Mango última salida (S) Griff letzter Auszug (S) Upper pole (S) Art. S532 € 29,00-
537		Manico ultima uscita (S) Mango última salida (S) Griff letzter Auszug (S) Upper pole (S) Art. S537 € 19,40-
538		Manico ultima uscita (S) Mango última salida (S) Griff letzter Auszug (S) Upper pole (S) Art. S538 € 33,90-
542		Manico ultima uscita (S) Mango última salida (S) Griff letzter Auszug (S) Upper pole (S) Art. S542 € 36,20-
542		Manico medio (M) Mango medio (M) Mittlerer Stiel (M) Medium handle Art. M542 € 36,20-
530 533 534 542 543 544 545 546 547		Clip telescopico piccolo Clip telescópico pequeño Kleiner Teleskop-Clip Small telescopic clip Art. R-542 € 7,00-

per/para/ für/for Art.		
542		Blocco per manico L Bloqueo para mango L Stopper für Teleskopstiel L Stop for telescopic handle large Art. R-542/1 € 7,50-
542		Blocco per manico S Bloqueo para mango S Stopper für Teleskopstiel S Stop for telescopic handle small Art. R-542/6 € 8,20-
542		Tappo Tapón Endstück Cap Art. R-542/2 € 2,70-
542		Clip di chiusura Bloqueo para mango S Stopper für Teleskopstiel S Stop for telescopic handle Art. R-542/3 € 9,10-
530 533 534 542 543 544 545 546 547		Guida corda piccola Guía cuerda pequeña Seilführung klein Small rope guide Art. R-542/4 € 6,70-
542		Guida corda grande Guía cuerda grande Seilführung groß Big rope guide Art. R-542/5 € 7,00-
530 533		Giuntura per manico Articulación para mango Verbindung für Stiel Connection for handle Art. R-530 € 9,70-
531 532 538		Blocco per manico L Bloqueo para mango L Stopper für Teleskopstiel L Stop for telescopic handle large Art. R-531 € 5,10-



per/para/ für/for Art.		
531 532 537 538		Fermo per manico telescopico Bloqueo para mango telescopico Schnapper für Teleskop-Stiel Stop for telescopic handle Art. R-532 € 9,00-
534		Giuntura per manico Articulación para mango Verbindung für Stiel Connection for handle Art. R-534 € 11,80-
535 536		Giuntura per manico Articulación para mango Verbindung für Stiel Connection for handle Art. R-535 € 7,80-
531 532 537 538		Tappo terminale Tapón terminal End- Verschlusskappe Cap Art. R-537 € 1,50-
531 532 537 538		Blocco per manico telescopico Bloqueo para mango telescopico Stopper für Teleskopstiel Stop for telescopic handle Art. R-538 € 11,70-
512 513 517 534		Molla per svettatoio Muelle para desmochador Feder Spring for shears Art. R-512 € 6,20-
519 530 533		Molla per tagliasiipi Muelle para recortasetos Feder für Heckenschere Spring for hedge shears Art. M-519 € 5,80-
513 517		Lama per seghetto Hoja para serrucho Sägeblatt für Säge Blade for saw Art. R-515 € 12,60-

per/para/ für/for Art.		
513 517 524 527 534		Lama per forbice Hoja para tijera Klinge für Schere Blade for shears Art. R-517 € 12,60-
514		Lama per seghetto Hoja para serrucho Sägeblatt für Säge Blade for saw Art. R-514 € 21,50-
515		Lama per seghetto Hoja para serrucho Sägeblatt für Säge Blade for saw Art. R-516 € 29,10-
513 517 530 533 534		Corda e maniglia Cuerda y manija Seil und Griff Rope and handle Art. C-513 € 10,00-
517		Manico per svettatoio Mango para desmochador Stiel für Raupenschere Handle for shears Art. M-517 € 34,50-

per/para/ für/for Art.	per/para/ für/for Art.	per/para/ für/for Art.
Stocker Seghetti Serruchos Sägen Saws	13530	1505
Lama per seghetto Hoja para serrucho Sägeblatt für Handsäge Blade for saw Scirocco 300 Art. R-13530 € 30,10-		Lama per seghetto Hoja para serrucho Sägeblatt für Handsäge Blade for saw Art. R-1505 € 18,30-
11518	14527	1506
Lama per seghetto Hoja para serrucho Sägeblatt für Handsäge Blade for saw Tornado 180 Art. R-11518 € 17,95-	Lama per seghetto Hoja para serrucho Sägeblatt für Handsäge Blade for saw Sirκος 270 Art. R-14527 € 25,35-	Lama per seghetto Hoja para serrucho Sägeblatt für Handsäge Blade for saw Art. R-1506 € 23,10-
12518	511 14533	15533
Lama per seghetto Hoja para serrucho Sägeblatt für Handsäge Blade for saw Sharki 180 Art. R-12518 € 20,85-	Lama per seghetto Hoja para serrucho Sägeblatt für Handsäge Blade for saw Sirκος 330 Art. R-14533 € 27,45-	Lama per seghetto Hoja para serrucho Sägeblatt für Handsäge Blade for saw Art. R-15533 € 22,55-
12521	1512	11518 11521 11524 11527 11530 12518 14527 14533
Lama per seghetto Hoja para serrucho Sägeblatt für Handsäge Blade for saw Suracon 210 LC Art. R-12521 € 23,25-	Lama per seghetto Hoja para serrucho Sägeblatt für Handsäge Blade for saw Hobby 210 Art. R-1512 € 16,30-	Bullone Bulón Bolzen Bolt Art. B-11518 € 2,75-
12621	1514	511 14527 14533
Lama per seghetto Hoja para serrucho Sägeblatt für Handsäge Blade for saw Suracon 210 LD Art. R-12621 € 20,05-	Lama per seghetto Hoja para serrucho Sägeblatt für Handsäge Blade for saw Hobby 250 Art. R-1514 € 18,60-	Kit viti e dadi Kit tornillos y tuercas Kit Schraube und Mutter Screws and nuts kit Art. 1513/1 € 1,50-
13521	1515	11518 12518
Lama per seghetto Hoja para serrucho Sägeblatt für Handsäge Blade for saw Scirocco 210 Art. R-13521 € 23,25-	Lama per seghetto Hoja para serrucho Sägeblatt für Handsäge Blade for saw Hobby 300 Art. R-1515 € 20,20-	Fermo lama Bloqueo hoja Schnapper Blade stopper Art. F-11518 € 2,75-
13524	1419 1519	12521 12621
Lama per seghetto Hoja para serrucho Sägeblatt für Handsäge Blade for saw Scirocco 240 Art. R-13524 € 26,55-	Lama per seghetto Hoja para serrucho Sägeblatt für Handsäge Blade for saw Hobby 180 Art. R-1419 € 15,40-	Bullone Bulón Bolzen Bolt Art. B-12621 € 6,55-
13527	1507 1513	12521 12621
Lama per seghetto Hoja para serrucho Sägeblatt für Handsäge Blade for saw Scirocco 270 Art. R-13527 € 28,25-	Lama per seghetto Hoja para serrucho Sägeblatt für Handsäge Blade for saw Art. R-1513 € 20,20-	Fermo lama Bloqueo hoja Schnapper Blade stopper Art. F-12621 € 3,25-

per/para/ für/for Art.
12621
Molla per seghetto Muelle para serrucho Feder für Klappsäge Spring for saw Art. M-12621 € 1,15-
1419
Fermolama con molla e perno Bloqueo hoja con muelle y perno Schnapper mit Feder und Bolzen Blade stopper with spring and pin Art. F-1419 € 1,80-
13521 13524
Fodero Fundas Hülle Sheath Art. F-13521 € 8,80-
13527 13530
Fodero Fundas Hülle Sheath Art. F-13527 € 8,60-
511 14527 14533
Fodero Fundas Hülle Sheath Art. F-14527 € 10,00-

per/para/ für/for Art.	per/para/ für/for Art.
Stocker Pompe Bombas Pumpen Sprayer	294 296
O-Ring per pistone O-Ring para pistón O-Ring für Zylinder O-rings set Art. R-292 € 0,70-	
254 1254	2906
Pompante Bombeador Pumpvorrichtung Pumper Art. P-254 € 15,80-	Guarnizione Junta Dichtung O-Ring Art. G-2906 € 4,50-
255 256 2911	2905
Pompante Bombeador Pumpvorrichtung Pumper Art. P-255 € 15,80-	O-Ring O-Ring O-Ring O-Ring Art. 2905/1 € 2,60-
240 260	230 237 238 239 1239 225 226 227 228 229 404 405 406
Pompante Bombeador Pumpvorrichtung Pumper Art. P260 € 41,50-	Impugnatura Empuñadura Griff Handle Art. 404/14 € 12,40-
261	226/12 226/15 226/16 403/3 404/10 404/11 404/14
Pompante con guarnizioni in FPM Bombeador con juntas de FPM Pumpvorrichtung mit FPM- Dichtungen Pumper with FPM-seals Art. 261/2 € 15,90-	Lancia in alluminio con guarnizioni in FPM Lanza de aluminio con juntas de FPM Aluminium-Sprühlanze mit FPM-Dichtungen Aluminium lance with FPM-seals Lunghezza/ Longitud/Länge/Length: 50 cm Art. 226/13 € 14,60-
254 255 256 2911	242 242/30 242/31 242/34 242/36 242/37 242/38 242/39 243 247 248 249 D-258 1247
Set O-Ring Set de juntas Set O-Ring O-rings set Art. V-255 € 4,00-	Lancia in alluminio con impugnatura Lanza de aluminio con empuñadura Aluminium-Sprühlanze mit Griff Aluminium lance with handle Lunghezza/ Longitud/Länge/Length: 69 cm Art. 242/33 € 15,50-
253 258 259	261
Set O-Ring Set de juntas Set O-Ring O-rings set Art. V-258 € 4,70-	Set O-Ring con guarnizioni in FPM Set O-Ring con juntas de FPM Set O-Ring mit FPM- Dichtungen O-rings set with FPM-seals Art. 261/1 € 4,60-

<p>per/para/ für/for Art.</p> <p>242/29 242/32 242/33 237/14 242/40 1258 G-252 G-258 G-259</p>  <p>Lancia in alluminio Lanza de aluminio Aluminium-Sprühlanze Aluminium lance</p> <p>Lunghezza/ Longitud/Länge/Length: 50 cm</p> <p>Art. 242/38 € 8,30-</p> <p>8 016604 302473</p>	<p>per/para/ für/for Art.</p> <p>237/13 237/14 237/15 242/29 242/30 242/32 242/33 242/40 1258 G-252 G-258 G-259 D-260</p>  <p>Lancia telescopica in alluminio Lanza telescópica de aluminio Teleskop-Sprühlanze aus Aluminium Telescopic aluminium lance</p> <p>Lunghezza/ Longitud/Länge/Length: 64 - 108 cm</p> <p>Art. 242/37 € 8,60-</p> <p>8 016604 402470</p>	<p>per/para/ für/for Art.</p> <p>242 242/32 242/34 242/35 243 247 248 249 1247</p>  <p>Impugnatura Empuñadura Griff Handle</p> <p>Art. 242/30 € 6,60-</p> <p>8 016604 802485</p>	<p>per/para/ für/for Art.</p> <p>254 255 256 2911</p>  <p>Lancia in ottone con impugnatura Lanza de latón con empuñadura Messing-Sprühlanze mit Griff Brass lance with handle</p> <p>Lunghezza/ Longitud/Länge/Length: 50 cm</p> <p>Art. G-255 € 13,00-</p> <p>8 016604 802553</p>	<p>per/para/ für/for Art.</p> <p>237/14 242/29 242/36 251 252 253 254 258 259 G-259</p>  <p>Ugello regolabile getto diretto o nebulizzazione Boquilla ajustable chorro directo o nebulización Regulierbare Düse mit Nebel- und Stechstrahlfunktion Adjustable nozzle direct jet or nebulization</p> <p>Art. D-251 € 5,30-</p> <p>8 016604 402517</p>	<p>per/para/ für/for Art.</p> <p>2905</p>  <p>Ugello regolabile getto diretto o nebulizzazione Boquilla ajustable chorro directo o nebulización Regulierbare Düse mit Nebel- und Stechstrahlfunktion Adjustable nozzle direct jet or nebulization</p> <p>Art. D2905 € 3,50-</p> <p>8 016604 929052</p>
<p>per/para/ für/for Art.</p> <p>237/13 242 242/30 242/34 242/35 242/36 242/37 242/38 242/39 243 247 248 249 1247 D-251 D-259 D-260</p>  <p>Lancia in fibra di vetro con impugnatura Lanza de fibra de vidrio con empuñadura Fiberglas-Sprühlanze mit Griff Fiberglass lance with handle</p> <p>Lunghezza/ Longitud/Länge/Length: 91 cm</p> <p>Art. 242/29 € 14,10-</p> <p>8 016604 102431</p>	<p>per/para/ für/for Art.</p> <p>237/13 242 242/29 242/30 242/31 242/32 242/33 242/34 242/35 242/38 247 1247 D-260 G-252 G-258 G-259</p>  <p>Lancia telescopica in alluminio con impugnatura Lanza telescópica de aluminio con empuñadura Teleskop-Sprühlanze aus Aluminium mit Griff Telescopic aluminium lance with handle</p> <p>Lunghezza/ Longitud/Länge/Length: 134 - 223 cm</p> <p>Art. 242/40 € 17,60-</p> <p>8 016604 102479</p>	<p>per/para/ für/for Art.</p> <p>240 241 242 243 247 248 249 260 260/11 1247 R-251</p>  <p>Lancia in ottone con impugnatura e fascetta Lanza de latón con empuñadura y abrazadera Messing-Sprühlanze mit Griff und Schellen Brass lance with handle and clamp</p> <p>Lunghezza/ Longitud/Länge/Length: 66 cm</p> <p>Art. G-260 € 21,70-</p> <p>8 016604 702600</p>	<p>per/para/ für/for Art.</p> <p>261</p>  <p>Lancia in ottone con guarnizioni in FPM Lanza de latón con juntas de FPM Messing-Sprühlanze mit FPM-Dichtungen Brass lance with FPM-seals</p> <p>Lunghezza/ Longitud/Länge/Length: 50 cm</p> <p>Art. 261/3 € 13,10-</p> <p>8 016604 702624</p>	<p>per/para/ für/for Art.</p> <p>255</p>  <p>Ugello regolabile getto diretto o nebulizzazione Boquilla ajustable chorro directo o nebulización Regulierbare Düse mit Nebel- und Stechstrahlfunktion Adjustable nozzle direct jet or nebulization</p> <p>Art. R-255 € 1,60-</p> <p>8 016604 602559</p>	<p>per/para/ für/for Art.</p> <p>2905</p>  <p>Ugello regolabile getto diretto o nebulizzazione Boquilla ajustable chorro directo o nebulización Regulierbare Düse mit Nebel- und Stechstrahlfunktion Adjustable nozzle direct jet or nebulization</p> <p>Art. D29052 € 3,50-</p> <p>8 016604 290527</p>
<p>per/para/ für/for Art.</p> <p>225 229 237/14 242/29 242/32 242/33 404 405 406 1258 D-251 D-259 G-252 G-258 G-259</p>  <p>Lancia in fibra di vetro Lanza de fibra de vidrio Fiberglas-Sprühlanze Fiberglass lance</p> <p>Lunghezza/ Longitud/Länge/Length: 71 cm</p> <p>Art. 242/36 € 7,30-</p> <p>8 016604 502477</p>	<p>per/para/ für/for Art.</p> <p>237/13 242/29 242/32 242/33 1258 D-260 G-252 G-258 G-259</p>  <p>Lancia telescopica in alluminio Lanza telescópica de aluminio Teleskop-Sprühlanze aus Aluminium Telescopic aluminium lance</p> <p>Lunghezza/ Longitud/Länge/Length: 113 - 203 cm</p> <p>Art. 242/39 € 9,70-</p> <p>8 016604 202476</p>	<p>per/para/ für/for Art.</p> <p>G-260</p>  <p>Lancia telescopica in ottone e alluminio Lanza telescópica de latón y aluminio Teleskop-Sprühlanze aus Messing und Aluminium Telescopic aluminium and brass lance</p> <p>Lunghezza/ Longitud/Länge/Length: 64 - 101 cm</p> <p>Art. 260/11 € 8,60-</p> <p>8 016604 202605</p>	<p>per/para/ für/for Art.</p> <p>242/30 242/32 242/33 242/39 242/40</p>  <p>Manometro per lance Manómetro para lanzas Druckmesser für Sprühlanzen Pressure gauge for lances</p> <p>Ø 3,5 cm</p> <p>Art. 242/34 € 6,80-</p> <p>8 016604 602481</p>	<p>per/para/ für/for Art.</p> <p>237/14 242/29 242/36 242/38 403/4 403/5 G-259</p>  <p>Set ugelli Set boquillas Düsenset Nozzles set</p> <p>Art. D-259 € 5,30-</p> <p>8 016604 902574</p>	<p>per/para/ für/for Art.</p> <p>254 255 256 2911</p>  <p>Valvola di sicurezza Válvula de seguridad Überdruckventil Security valve</p> <p>Art. R-254 € 1,60-</p> <p>8 016604 902543</p>
<p>per/para/ für/for Art.</p> <p>237/13 242 242/30 242/31 242/34 242/36 242/38 243 247 248 249 1247 D-260</p>  <p>Lancia telescopica in alluminio con impugnatura Lanza telescópica de aluminio con empuñadura Teleskop-Sprühlanze aus Aluminium mit Griff Telescopic aluminium lance with handle</p> <p>Lunghezza/ Longitud/Länge/Length: 85 - 128 cm</p> <p>Art. 242/32 € 15,90-</p> <p>8 016604 802478</p>	<p>per/para/ für/for Art.</p> <p>230 235 236 237 238 239 1239 226/13 242/36 242/38 D-251 D-259</p>  <p>Lancia in fibra di vetro con tubo, impugnatura e ugelli Lanza de fibra de vidrio con tubo, empuñadura y boquillas Fiberglas-Sprühlanze mit Schlauch, Griff und Düsen Fiberglass lance with tube, handle and nozzles</p> <p>Lunghezza/ Longitud/Länge/Length: 67 cm</p> <p>Art. 237/14 € 13,00-</p> <p>8 016604 402388</p>	<p>per/para/ für/for Art.</p> <p>254 255 256 2911</p>  <p>Lancia telescopica in ottone con impugnatura Lanza telescópica de latón con empuñadura Teleskop-Messing-Sprühlanze mit Griff Telescopic brass lance with handle</p> <p>Lunghezza/ Longitud/Länge/Length: 60 - 89 cm</p> <p>Art. G-253 € 12,60-</p> <p>8 016604 902536</p>	<p>per/para/ für/for Art.</p> <p>237/14 242/29 242/32 242/36 242/37 242/39 242/40 261/3 G-252 G-255 G-259</p>  <p>Campana diserbo Campana escardo Sprühkegel Herbicide hood 9 x 30 cm</p> <p>Art. D-260 € 6,60-</p> <p>8 016604 902604</p>	<p>per/para/ für/for Art.</p> <p>260/11 G-251 G-260</p>  <p>Set guarnizioni Set juntas Set Dichtung Seals kit</p> <p>Art. 242/35 € 2,60-</p> <p>8 016604 602474</p>	<p>per/para/ für/for Art.</p> <p>2906</p>  <p>Ugello regolabile getto diretto o nebulizzazione Boquilla ajustable chorro directo o nebulización Regulierbare Düse mit Nebel- und Stechstrahlfunktion Adjustable nozzle direct jet or nebulization</p> <p>Art. D-2906 € 3,60-</p> <p>8 016604 829062</p>
<p>per/para/ für/for Art.</p> <p>225 226 226/13 227 228 229 235 236 403</p>  <p>Ugello regolabile getto diretto o nebulizzazione Boquilla ajustable chorro directo o nebulización Regulierbare Düse mit Nebel- und Stechstrahlfunktion Adjustable nozzle direct jet or nebulization</p> <p>Art. 226/16 € 2,10-</p> <p>8 016604 102271</p>	<p>per/para/ für/for Art.</p> <p>2907</p>  <p>Ugello regolabile getto diretto o nebulizzazione Boquilla ajustable chorro directo o nebulización Regulierbare Düse mit Nebel- und Stechstrahlfunktion Adjustable nozzle direct jet or nebulization</p> <p>Art. D-2907 € 3,60-</p> <p>8 016604 929076</p>	<p>per/para/ für/for Art.</p> <p>291</p>  <p>Set O-ring Set de juntas Set O-ring O-rings set</p> <p>Art. V-291 € 3,90-</p> <p>8 016604 802911</p>	<p>per/para/ für/for Art.</p> <p>291</p>  <p>Serbatoio 2 L Tanque 2 L Tank 2 L</p> <p>Art. S-291 € 6,30-</p> <p>8 016604 702914</p>		

per/para/ für/for Art.			per/para/ für/for Art.			per/para/ für/for Art.		
291		Testa Cabeza Sprühkopf Head Art. C-291 € 10,60- 8 0166044602917	299		Ugello regolabile getto diretto o nebulizzazione Boquilla ajustable chorro directo o nebulización Regulierbare Düse mit Nebel- und Stechstrahlfunktion Adjustable nozzle direct jet or nebulization Art. 299/1 € 5,60- 8 0166044902994	225-9 226-7-8 230-5-6 237-8-9 1239 242-7 1247 401-2-3 404-5-6		Misurino dosatore graduato Vaso medidor graduado Messbecher mit Maßanzeige Graduated measuring cup Art. 237/17 € 0,70- 8 0166044102387
262		Testa Cabeza Sprühkopf Head Art. 262/1 € 8,90- 8 0166044602627	299		Testa con guarnizione in FPM Cabeza con junta de FPM Sprühkopf mit FPM-Dichtung Head with FPM-seal Art. 299/2 € 13,20- 8 0166044802997	237/15		Leva e valvola per impugnatura Palanca y válvula para empuñadura Hebel und Ventil für Handgriff Lever and valve for handle Art. 237/18 € 5,90- 8 0166044802393
262 300 306 307 2621		Serbatoio 2 L Tanque 2 L Tank 2 L Tank 2 L Art. 262/2 € 7,00- 8 0166044502620	278		Doccia Ducha Brause Shower head Art. 278/1 € 4,50- 8 0166044902789	300		Ugello regolabile getto diretto o nebulizzazione Boquilla ajustable chorro directo o nebulización Regulierbare Düse mit Nebel und Stechstrahlfunktion Adjustable nozzle direct jet or nebulization Art. 300/1 € 1,50- 8 0166044803000
262		Set O-Ring Set O-Ring Set O-Ring O-rings set Art. 262/3 € 3,00- 8 0166044402623	263 264 270		Doccia Ducha Brause Shower head Art. 263/1 € 3,20- 8 0166044902635	300		Testa Cabeza Sprühkopf Head Art. 300/2 € 7,90- 8 0166044703003
295 297		Ugello regolabile getto diretto o nebulizzazione Boquilla ajustable chorro directo o nebulización Regulierbare Düse mit Nebel- und Stechstrahlfunktion Adjustable nozzle direct jet or nebulization Art. 295/1 € 4,20- 8 0166044902956	265 266 271		Doccia Ducha Brause Shower head Art. 265/1 € 3,20- 8 0166044902659	306		Ugello regolabile getto diretto o nebulizzazione Boquilla ajustable chorro directo o nebulización Regulierbare Düse mit Nebel und Stechstrahlfunktion Adjustable nozzle direct jet or nebulization Art. 306/1 € 1,60- 8 0166044902987
295		Serbatoio 1,5 L Tanque 1,5 L Tank 1,5 L Tank 1,5 L Art. 295/2 € 5,70- 8 0166044802959	272 275 276		Doccia Ducha Brause Shower head Art. 275/1 € 4,90- 8 0166044902758	306		Testa Cabeza Sprühkopf Head Art. 306/2 € 8,30- 8 0166044802980
297		Serbatoio 2 L Tanque 2 L Tank 2 L Tank 2 L Art. 297/2 € 6,20- 8 0166044902970	273 281 284 283 288		Doccia Ducha Brause Shower head Art. 283/1 € 4,90- 8 0166044902833	307		Testa con ugello per schiuma Cabeza con boquilla de espuma Sprühkopf mit Schaumdüse Head with foam nozzle Art. 307/1 € 12,65- 8 0166044703256
295 297		Testa Cabeza Sprühkopf Head Art. 295/3 € 5,50- 8 0166044702952	274 285 286		Doccia Ducha Brause Shower head Art. 285/1 € 4,90- 8 0166044902857	307		Ugello per schiuma Boquilla de espuma Schaumdüse Foam nozzle Art. 307/2 € 2,25- 8 0166044603259

per/para/ für/for Art.		
		
26201 26202		Testina doccia Cabezal ducha Brause Shower head Art. R-26201 € 11,40- 8 0166044262210
26201 26202		Raccordo Conector Anschluss Connector Art. R-26202 € 12,10- 8 0166044262227
26203 26209		Testina doccia Cabezal ducha Brause Shower head Art. R-26203 € 2,50- 8 0166044262234

per/para/ für/for Art.		
		
2270 2274 2275 2282 2288 2289 2470 2474 2475 2482 2488 2489		Manico in legno 1,3 m Mango de madera 1,3 m Holzstiel 1,3 m Wooden handle 1,3 m Art. 2214 € 5,90- 8 0166044022142
2271 2283 2471 2483		Manico in legno 1,3 m Mango de madera 1,3 m Holzstiel 1,3 m Wooden handle 1,3 m Art. 2223 € 6,00- 8 0166044022234
2272 2273 2284 2285 2472 2473 2484 2485		Manico in legno 1,3 m Mango de madera 1,3 m Holzstiel 1,3 m Wooden handle 1,3 m Art. 2222 € 6,25- 8 0166044022227
2276 2476		Manico in legno 1 m Mango de madera 1 m Holzstiel 1 m Wooden handle 1 m Art. 2211 € 6,00- 8 0166044022111
2277 2278 2279 2477 2478 2479 2480 2492 2493		Manico in legno 1,4 m Mango de madera 1,4 m Holzstiel 1,4 m Wooden handle 1,4 m Art. 2212 € 5,80- 8 0166044022128
2286 2287 2481 2486 2487		Manico in legno 1,4 m Mango de madera 1,4 m Holzstiel 1,4 m Wooden handle 1,4 m Art. 2225 € 6,45- 8 0166044022258

per/para/ für/for Art.		
		
2057		Molla esterna per legatrice Muelle externo para atadora Äußere Feder für Bindegänge External spring for binding machine Art. M-2057 € 2,20- 8 0166044521577
2057		Molla interna per legatrice Muelle interno para atadora Innere Feder für Bindegänge Internal spring for binding machine Art. R-2057 € 1,90- 8 0166044920578
752 753		Custodia per ascia Custodia para hacha Hülle für Axt Sheath for ax Art. 752/1 € 6,00- 8 0166044907524
752/1 754/1 755/1 757/1		Blocco di chiusura Bloqueo de cierre Verschluss Locking clip Art. 752/2 € 0,80- 8 0166044807527
760 761		Custodia per ascia Funda para hacha Hülle für Forstbeil Sheath for ax Art. 760/1 € 6,80- 8 0166044907609
754		Custodia per ascia Custodia para hacha Hülle für Axt Sheath for ax Art. 754/1 € 9,20- 8 0166044907548
762		Custodia per ascia Funda para hacha Hülle für Axt Sheath for ax Art. 762/1 € 9,30- 8 0166044907623

per/para/
für/for
Art.

755
756



Custodia per roncola
Custodia para machete
Hülle für Machete
Sheath for billhook

Art. 755/1
€ 12,50-

8 016604 907555

757
758



Custodia per roncola
Custodia para machete
Hülle für Machete
Sheath for billhook

Art. 757/1
€ 13,30-

8 016604 907579

2157



Kit lame per legatrice
Kit hojas para atadora
Klingen-Kit für Bindezeange
Blades kit for binding machine

Art. L2157
€ 5,80-

8 016604 821578

2157



Molla per legatrice
Muelle para atadora
Feder für Bindezeange
Spring for binding machine

Art. M2157
€ 4,10-

8 016604 921575

2157



Pin di fissaggio
Pin de fisaje
Fixier-Stift
Fixing pin

Art. P2157
€ 0,80-

8 016604 621574

2157



Ingranaggio
Engranaje
Zahnrad
Gear

Art. S2157
€ 4,80-

8 016604 721571

2170



Lama per innestatrice
Hoja para máquina de injerto
Klinge für Veredelungszeange
Blade for grafting machine

Art. 2171
€ 9,40-

8 016604 021718

2170



Controlama per innestatrice
Contra hoja para máquina de injerto
Gegenklinge für Veredelungszeange
Anvil for grafting machine

Art. 2172
€ 16,40-

8 016604 021725

per/para/
für/for
Art.

2170



Molla per innestatrice
Muelle para máquina de injerto
Feder für Veredelungszeange
Spring for grafting machine

Art. 2173
€ 1,70-

8 016604 021732

2170



Sostegno per lama
Sostén para hoja
Klingenthalterung
Support for blade

Art. R-2170
€ 8,50-

8 016604 921704

746
751



Fodero
Funda
Hülle
Sheath

Art. F-751
€ 7,50-

8 016604 907517

Accessori giardino
Accesorios para jardín
Gartenzubehör
Garden accessoires

1662
1663
1664
1665
1668
1669
1670
1671
1674
1675
1676
1677

2157



Tira zip per abbigliamento riscaldabile
Tirador de cremallera para ropa calentable
Reißverschlusschieber für beheizbare Bekleidung
Zip puller for heatable clothing

Art. 1668/1
€ 0,60-

8 016604 916687

per/para/
für/for
Art.

Stocker
Stocktap

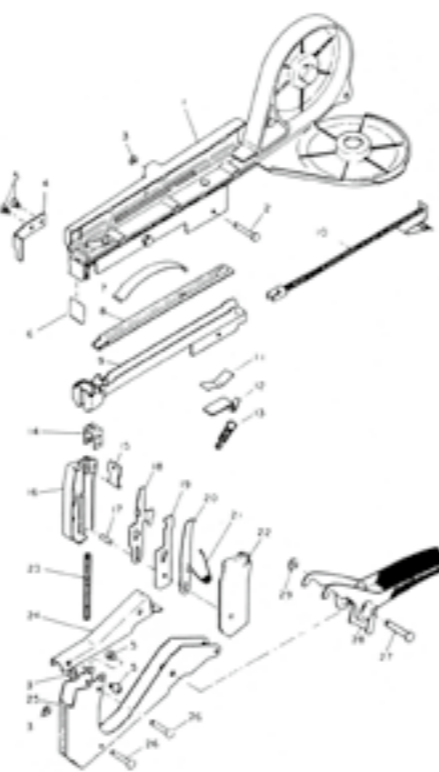

Ricambi per Legatrice STOCKTAP
Recambios para atadoras STOCKTAP
Ersatzteile für Bindezeange STOCKTAP
Replacement parts for STOCKTAP

per/para/für/for Art. 2055.

Index/Indice Nr.	Art.	€
1	R-67	18,90-
2	R-78	1,00-
3	R-75	0,10-
4	R-55	1,80-
5	R-56	0,70-
6	2067	6,40-
7	R-57	1,80-
8	R-58	2,20-
9	R-59	13,10-
10	R-60	7,00-
11	R-72	1,50-
12	R-73	1,70-
13	R-61	2,00-
14	R-71	2,20-
15	R-74	0,90-
16	R-68	3,60-
17	R-80	1,40-
18	R-76	2,60-
19	R-77	2,00-
20	R-62	2,90-
21	R-66	1,50-
22	R-69	3,60-
23	R-70	1,30-
24	R-81	8,60-
25	R-82	16,30-
26	R-79	1,20-
27	R-63	1,30-
28	R-64	11,00-
29	R-65	0,60-

per/para/
für/for
Art.

Stocker
Serre
Gewächshäuser

9610

Telo
Folie

Art. 9610/1
€ 80,00-

8 016604 996108

9610
9639
9641

Clip
Clip

Art. 9610/2
€ 1,00-

8 016604 896101

9610
9639
9641

Fascetta
Schelle

Art. 9610/3
€ 1,40-

8 016604 796104

9610
9639
9641

Gancio
Haken

Art. 9610/4
€ 0,25-

8 016604 696107

9610
9639
9641

Piastrina per piede
Fussplatte

Art. 9610/5
€ 3,15-

8 016604 596100

9610
9639
9641

Vite
Schraube

Art. 9610/6
€ 0,90-

8 016604 496103

9610
9639
9641

Tenditore
Spanner

Art. 9610/7
€ 3,85-

8 016604 396106

per/para/
für/for
Art.

9641



Porta supplementare
Zusatztür

Art. 9610/9
€ 304,00-

8 016604 196102

9639

Telo
Folie

Art. 9639/1
€ 102,50-

8 016604 996399

9641

Telo
Folie

Art. 9641/1
€ 195,50-

8 016604 996412

9639
9641



Ventilazione laterale 6 m
Seitenlüftung 6 m

Art. 9641/2
€ 349,00-

8 016604 896415

per/para/
für/for
Art.

Stocker
Solarjet

Batteria 600 AA
Bateria 600 AA
Batterie 600 AA
Battery 600 AA

600mAh AA Ni-Mh

Art. 0200
€ 8,20-

8 016604 302008

0700



Pannello
Panel
Panel
Panel

Art. P0700
€ 20,30-

8 016604 907005

0700



Puntale
Punta
Spitz
Tip

Art. R0700
€ 22,30-

21 V POWER LINE
Stocker

Compatibile con le batterie della linea POWER 21 V.
Compatible con baterías de la línea POWER 21 V.
Kompatibel mit POWER 21 V Batterien.
Compatible with batteries of the POWER 21 V line.



- Ⓛ Ricambi
- ⓔ Recambios
- ⓓ Ersatzteile
- Ⓢ Spare parts

Art. 312, 621

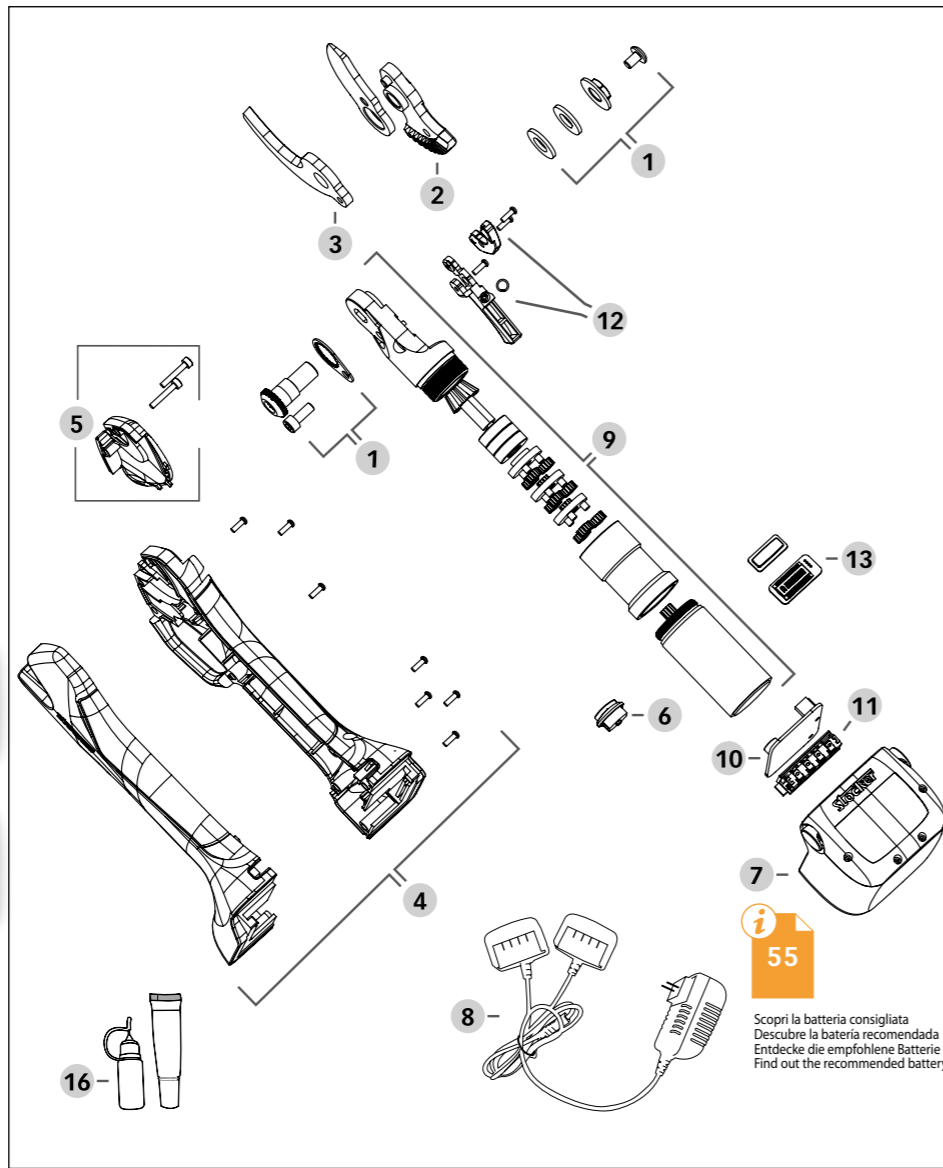

#	Art.	IT	ES	DE	EN	€
1	312/1	Kit di fissaggio lama	Kit de fijación hoja	Fixier-Kit für Klinge	Fixing blade kit	14,25-
2	312/2	Lama per forbice elettrica	Hoja para tijera eléctrica	Klinge für elektrische Baumschere	Blade for electric shears	29,55-
3	312/3	Controlama per forbice elettrica	Contra hoja para tijera eléctrica	Gegenklinge für elektrische Baumschere	Anvil for electric shears	17,85-
4	312/4	Set copertura per forbice elettrica	Set cobertura para tijera eléctrica	Abdeckungsset für elektrische Baumschere	Cover for electric shears set	19,85-
5	312/5	Copertura di testa per forbice elettrica	Cobertura de cabeza para tijera eléctrica	Kopfabdeckung für elektrische Baumschere	Head cover for electric shears	5,40-
6	310/6	Interruttore	Interruptor	Ein-/Ausschalter	Power button	1,80-
8	312/8	Caricabatterie doppio 21 V	Cargador doble 21 V	Zweifach-Ladegerät 21 V	Double battery charger 21 V	27,05-
9	312/9	Motoriduttore con attacco per lama	Motorreductor con conexión para hoja	Reduziergetriebe mit Motor	Geared motor with connection for blade	145,50-
10	312/10	Circuito stampato	Circuito impreso	Leiterplatte	Printed circuit board	92,00-
11	312/11	Contatti per batteria	Contactos batería	Batteriekontakte	Battery contacts	5,75-
12	312/12	Grilletto con sensore	Gatillo con sensor	Auslöser mit Sensor	Trigger with sensor	16,05-
13	312/13	Display LED	Pantalla LED	LED Display	Display LED	19,65-
	312/14	Kit viti completo	Kit tornillos completo	Kit Schrauben komplett	Complete screws set	5,75-
	312/15	Valigetta per forbice elettrica	Maletín para tijera eléctrica	Koffer für elektrische Baumschere	Suitcase for electric shears	22,55-
16	310/18	Set olio e grasso	Set de aceite y grasa	Set Schmierfett und Schmieröl	Oil and grease set	5,10-
7	312/7	Batteria Power 21 V 2,6 Ah	Batería Power 21 V 2,6 Ah	Batterie Power 21 V 2,6 Ah	Battery Power 21 V 2,6 Ah	73,50-
7	325	Batteria Power 21 V 4,0 Ah	Batería Power 21 V 4,0 Ah	Batterie Power 21 V 4,0 Ah	Battery Power 21 V 4,0 Ah	118,00-
7	328	Batteria Power 21 V 8,0 Ah	Batería Power 21 V 8,0 Ah	Batterie Power 21 V 8,0 Ah	Battery Power 21 V 8,0 Ah	203,00-



Art. 584,585

- Ⓛ Ricambi
- ⓔ Recambios
- ⓓ Ersatzteile
- Ⓢ Spare parts

Art. 580, 581

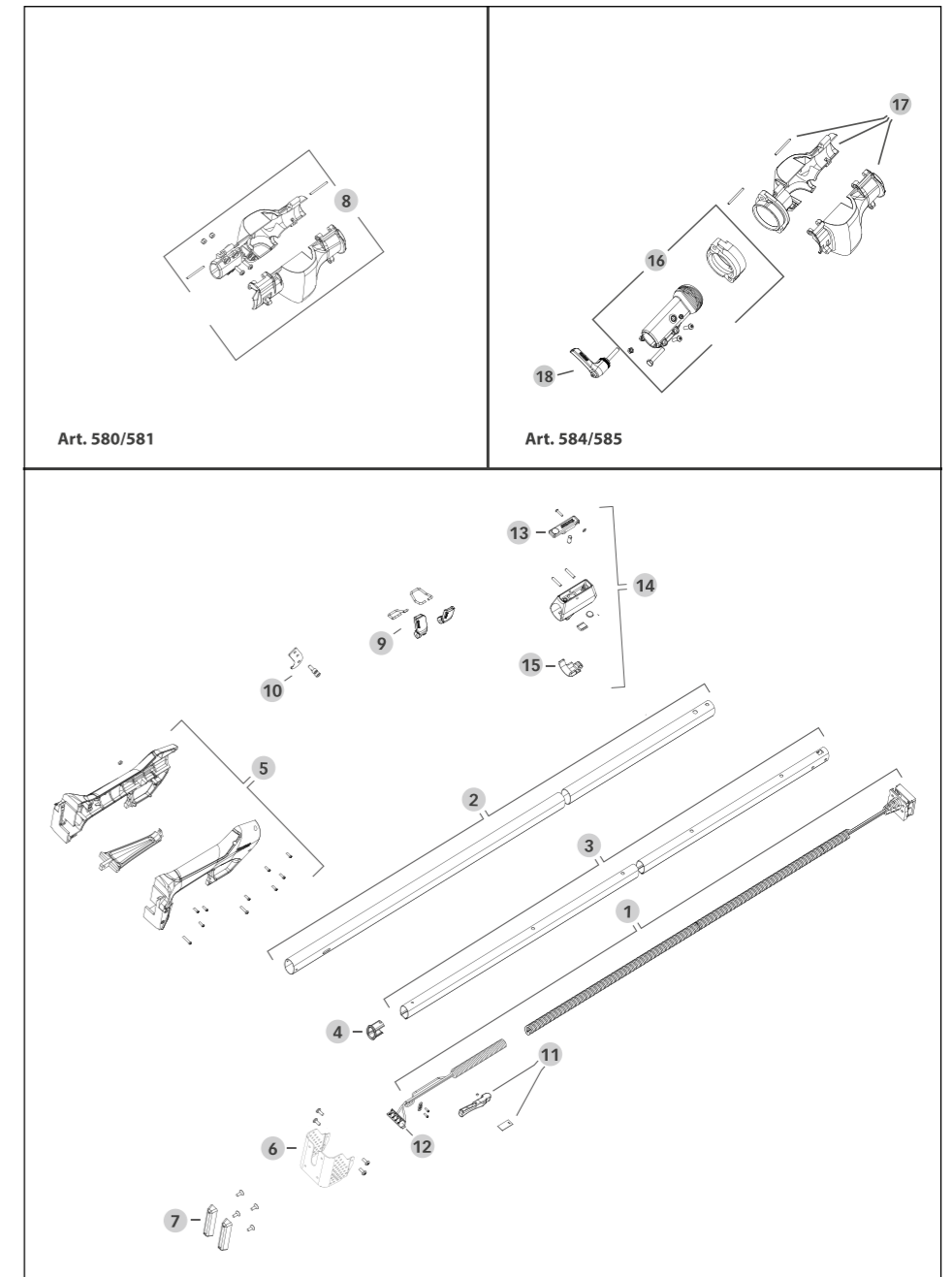

Art. 580/581

Art. 584/585

#	Art.	IT	ES	DE	EN	€
1	580/1	Cavo di alimentazione (Art. 580, 584)	Cable de alimentación (Art. 580, 584)	Kabel (Art. 580, 584)	Cable (Art. 580, 584)	58,20-
1	581/1	Cavo di alimentazione (Art. 581, 585)	Cable de alimentación (Art. 581, 585)	Kabel (Art. 581, 585)	Cable (Art. 581, 585)	77,40-
2	580/2	Tubo esterno con rivestimento antiscivolo (Art. 580, 584)	Tubo externo con revestimiento antideslizante (Art. 580, 584)	Außenrohr mit Antirutschbelag (Art. 580, 584)	External tube with non-slip grip (Art. 580, 584)	27,30-
2	581/2	Tubo esterno con rivestimento antiscivolo (Art. 581, 585)	Tubo externo con revestimiento antideslizante (Art. 581, 585)	Außenrohr mit Antirutschbelag (Art. 581, 585)	External tube with non-slip grip (Art. 581, 585)	31,90-
3	580/3	Tubo interno (Art. 580, 584)	Tubo interno (Art. 580, 584)	Innenrohr (Art. 580, 584)	Internal tube (Art. 580, 584)	20,95-
3	581/3	Tubo interno (Art. 581, 585)	Tubo interno (Art. 581, 585)	Innenrohr (Art. 581, 585)	Internal tube (Art. 581, 585)	24,25-
4	580/4	Protezione tubo interno per cavo	Protección tubo interno para cable	Interner Rohrschutz für Kabel	Internal tube protection for cable	1,65-
5	580/5	Set copertura per impugnatura	Set cobertura para empuñadura	Abdeckungsset für Griff	Cover for handle set	24,60-
6	580/6	Protezione per batteria fino a 4 Ah	Protección batería hasta 4 Ah	Batterieschutz bis 4 Ah	Battery protection up to 4 Ah	8,20-
6	580/14	Protezione per batteria fino a 8 Ah	Protección batería hasta 8 Ah	Batterieschutz bis 8 Ah	Battery protection up to 8 Ah	11,15-
7	580/7	Gommini d'appoggio	Gomitas de apoyo	Gummi-Stoßschutz	Rubber feet	4,00-
8	580/8	Set copertura per alloggiamento Magma	Set cobertura para alojamiento Magma	Abdeckungsset für Magma	Cover for Magma'slot set	33,10-
9	580/9	Clip di chiusura per alloggiamento forbice	Clip de cierre para alojamiento tijera	Verschlossclips für Scherenhalterung	Locking clips for shears/slot	10,40-
10	580/10	Gancio	Gancho	Hacken	Hook	8,20-
11	580/11	Grilletto con sensore	Gatillo con sensor	Auslöser mit Sensor	Trigger with sensor	6,75-
12	580/12	Contatti per batteria	Contactos batería	Batteriekontakte	Battery contacts	5,80-
	580/13	Kit viti completo	Kit tornillos completo	Kit Schrauben komplett	Complete screws set	5,80-
13	559/2	Pulsante di bloccaggio	Botón de bloqueo	Blockierknopf	Locking button	3,00-
14	565/3	Blocco Profi	Bloqueo Profi	Blockiersystem Profi	Profi stopper	9,50-
15	565/2	Leva di bloccaggio Profi	Palanca de bloqueo Profi	Blockierknopf Profi	Locking clip Profi	3,00-
16	584/1	Attacco a sfera per alloggiamento Magma (Art. 584, 585)	Conexión de bola para carcasa Magma (Art. 584, 585)	Kugelgelenk für Magma Halterung (Art. 584, 585)	Ball attachment for Magma housing (Item 584, 585)	22,50-
17	584/2	Alloggiamento Magma per attacco a sfera (Art. 584, 585)	Carcasa Magma para conexión de bola (Art. 584, 585)	Magma Halterung für Kugelgelenk (Art. 584, 585)	Magma housing for ball attachment (Item 584, 585)	38,65-
18	584/3	Leva di bloccaggio (Art. 584, 585)	Palanca de bloqueo (Art. 584, 585)	Blockierknopf (Art. 584, 585)	Locking clip (Item 584, 585)	10,50-
	584/4	Kit viti completo (Art. 584, 585)	Kit tornillos completo (Art. 584, 585)	Kit Schrauben komplett (Art. 584, 585)	Complete screws kit (Item 584, 585)	6,85-

21 V POWER LINE Stocker



Compatibile con le batterie della linea POWER 21 V.
Compatible con baterías de la línea POWER 21 V.
Kompatibel mit POWER 21 V Batterien.
Compatible with batteries of the POWER 21 V line.

- ① Ricambi
- Ⓔ Recambios
- Ⓓ Ersatzteile
- Ⓞ Spare parts

Art. 629

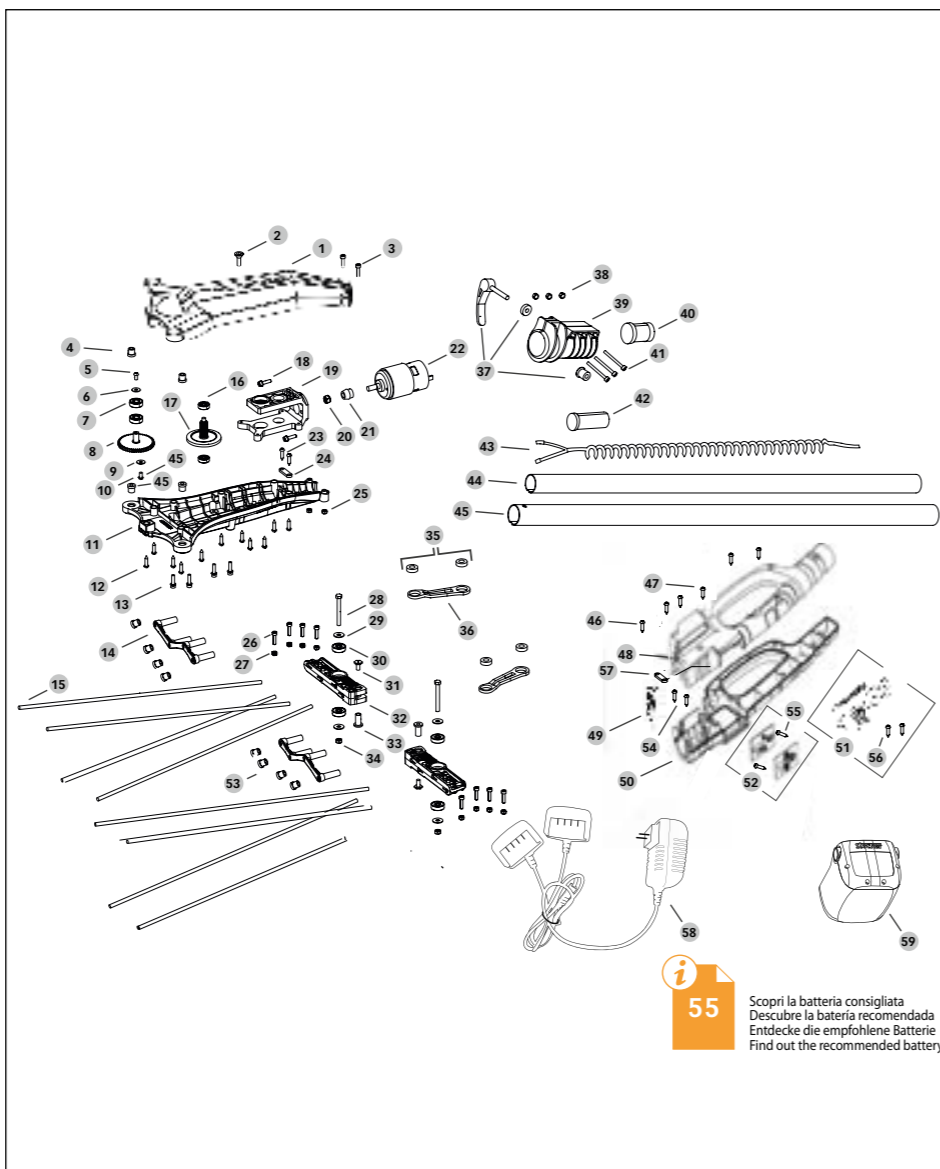

55 Scopri la batteria consigliata
Descubre la batería recomendada
Entdecke die empfohlene Batterie
Find out the recommended battery

21 V POWER LINE Stocker



Compatibile con le batterie della linea POWER 21 V.
Compatible con baterías de la línea POWER 21 V.
Kompatibel mit POWER 21 V Batterien.
Compatible with batteries of the POWER 21 V line.

- ① Ricambi
- Ⓔ Recambios
- Ⓓ Ersatzteile
- Ⓞ Spare parts

Art. 624

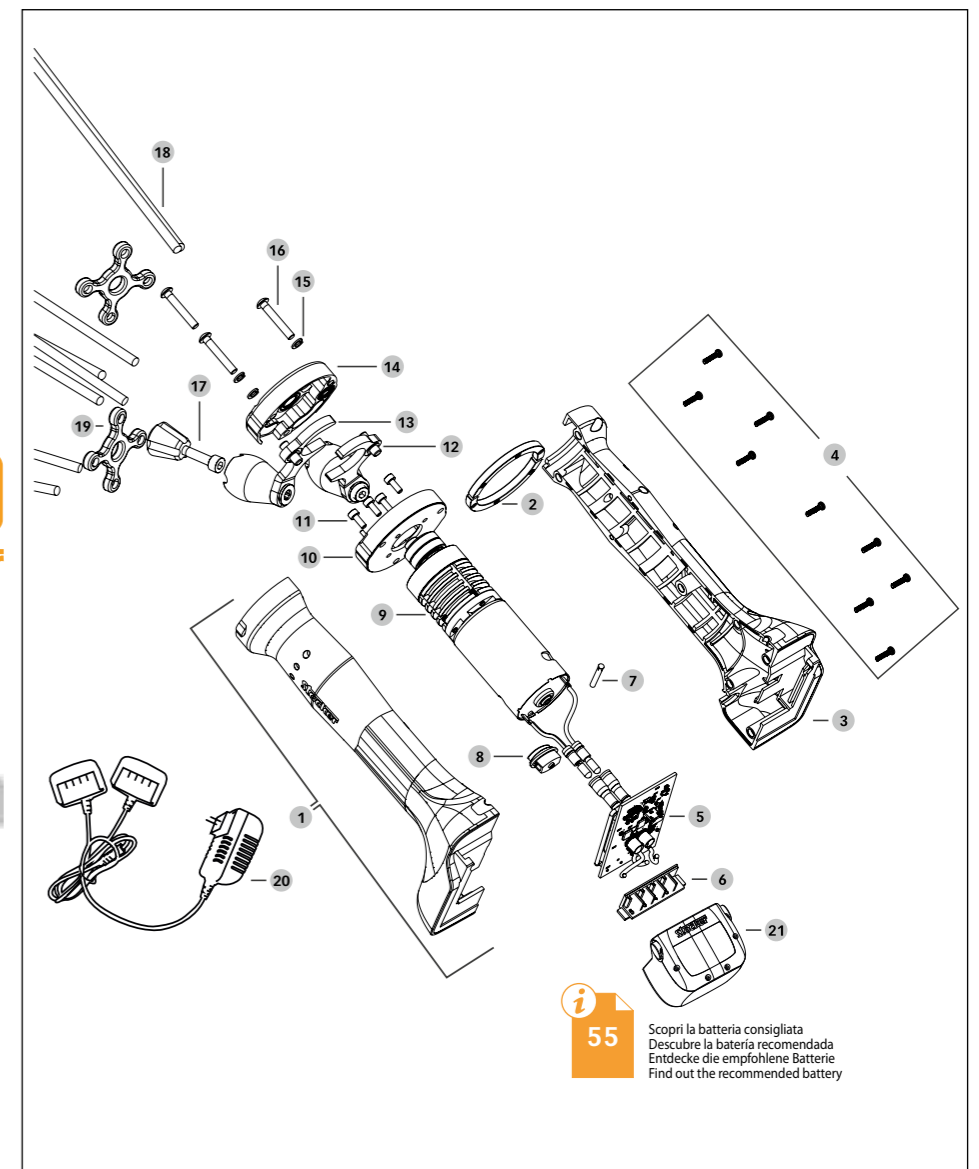

55 Scopri la batteria consigliata
Descubre la batería recomendada
Entdecke die empfohlene Batterie
Find out the recommended battery

#	Art.	IT	ES	DE	EN	€
15	629/1	Astina in carbonio Ø 5 mm, 35 cm	Barra de carbonio Ø 5 mm, 35 cm	Karbon Stangen Ø 5 mm, 35 cm	Carbon rod Ø 5 mm, 35 cm	4,00-
14x2 + 53x8	629/2	Anti-breaking	Anti-Breaking	Anti-Breaking	Anti-Breaking	6,50-
26x8 + 27x8 + 28x2 + 29x4 + 30x4 + 31x2 + 32x2 + 33x2 + 34x2	629/3	Supporto per astine in carbonio	Soporte para barra de carbonio	Halterung für Karbonstangen	Carbon rod holder	40,65-
5 + 6 + 7x2 + 8 + 9 + 10 + 16x2 + 17 + 18x2 + 19 + 20 + 21 + 22 + 35x4 + 36x2	629/4	Motoriduttore con bielle	Motorreductor con bielas	Reduziergetriebe mit Pleuelstangen	Geared motor with connecting rods	191,50-
1 + 2 + 3x2 + 4x4 + 11 + 12x11 + 13x4 + 23x2 + 24 + 25x2	629/5	Set copertura di testa	Set cobertura de cabeza	Kopfbedeckungsset	Head cover set	38,60-
37 + 38x3 + 39 + 40 + 41x3	629/6	Kit blocco completo asta telescopica	Kit bloqueo completo mango telescópico	Blockiersystem für Teleskopstiel	Telescopic locking kit	11,55-
42 + 44	629/7	Tubo interno	Tubo interno	Innenrohr	Internal tube	15,15-
45	629/8	Tubo esterno	Tubo externo	Außenrohr	External tube	17,50-
43	629/9	Cavo interno a spirale	Cable interno enrollado	Spiralförmige interne Kabel	Internal coiled cable	32,50-
46x1 + 47x7 + 48 + 50 + 54x2 + 57	629/10	Set impugnatura	Set empuñadura	Griffset	Handle set	41,95-
49	312/11	Contatti per batteria	Contactos batería	Batteriekontakte	Battery contacts	5,75-
51 + 56x2	629/11	Circuito stampato	Circuito impreso	Leiterplatte	Printed circuit board	104,00-
52 + 55x2	629/12	Display di comando	Pantalla de control	Kontrolldisplay	Control display	5,35-
2 + 3x2 + 5 + 10 + 12x11 + 13x4 + 18x2 + 20 + 23x2 + 24 + 25x2 + 26x8 + 27x8 + 28x2 + 29x4 + 31x2 + 32x2 + 34x2 + 38x3 + 41x3 + 46x1 + 47x7 + 55x2 + 56x2 + 57	629/13	Set viti	Set tornillos	Schraubenset	Screws set	10,65-
58	312/8	Caricabatterie doppio 21 V	Cargador doble 21 V	Zweifach-Ladegerät 21 V	Double battery charger 21 V	27,05-
59	312/7	Batteria Power 21 V 2,6 Ah	Batería Power 21 V 2,6 Ah	Batterie Power 21 V 2,6 Ah	Battery Power 21 V 2,6 Ah	73,50-
59	325	Batteria Power 21 V 4,0 Ah	Batería Power 21 V 4,0 Ah	Batterie Power 21 V 4,0 Ah	Battery Power 21 V 4,0 Ah	118,00-
59	328	Batteria Power 21 V 8,0 Ah	Batería Power 21 V 8,0 Ah	Batterie Power 21 V 8,0 Ah	Battery Power 21 V 8,0 Ah	203,00-

#	Art.	IT	ES	DE	EN	€
18	624/1	Astina in carbonio	Barra de carbonio	Carbon Stangen	Carbon rod	4,15-
19x2	624/2	Anti-Breaking	Anti-Breaking	Anti-Breaking	Anti-Breaking	2,25-
13	624/3	Biella sinistra	Biela izquierda	Pleuel links	Left connecting rod	37,60-
12	624/4	Biella destra	Biela derecha	Pleuel rechts	Right connecting rod	37,60-
17x2	624/5	Blocca astine con bulloni	Bloqueador varillas con tornillos	Stangenfixierung mit Schrauben	Rod locks with bolts	22,80-
2 + 10 + 11x4 + 14 + 15x3 + 16x3	624/6	Assieme carter di testa con viti	Conjunto carcasa del cabezal con tornillería	Kopfabdeckung mit Schrauben	Crankcase assembly with screws	92,20-
1 + 3 + 4x9 + 7	624/7	Set copertura con viti e indicatore LED	Juego de fundas con tornillos y indicador LED	Abdeckungsset mit Schrauben und LED-Anzeige	Cover set with screws and Led indicator	21,55-
9	624/8	Motoriduttore	Motorreductor	Reduziergetriebe	Geared motor	253,00-
5	624/9	Circuito stampato	Circuito impreso	Leiterplatte	Printed circuit board	152,00-
6	312/11	Contatti per batteria	Contactos batería	Batteriekontakte	Battery contacts	5,75-
4x9 + 11x4 + 16x3 + 15x3	624/11	Kit viti completo	Kit tornillos completo	Kit Schrauben komplett	Complete screws kit	7,60-
8	310/6	Interruttore	Interruptor	Ein-/Ausschalter	Power button	1,80-
20	312/8	Caricabatterie doppio 21 V	Cargador doble 21 V	Zweifach-Ladegerät 21 V	Double battery charger 21 V	27,05-
21	312/7	Batteria Power 21 V 2,6 Ah	Batería Power 21 V 2,6 Ah	Batterie Power 21 V 2,6 Ah	Battery Power 21 V 2,6 Ah	73,50-
21	325	Batteria Power 21 V 4,0 Ah	Batería Power 21 V 4,0 Ah	Batterie Power 21 V 4,0 Ah	Battery Power 21 V 4,0 Ah	118,00-
21	328	Batteria Power 21 V 8,0 Ah	Batería Power 21 V 8,0 Ah	Batterie Power 21 V 8,0 Ah	Battery Power 21 V 8,0 Ah	203,00-

21 V POWER LINE
Stocker

Compatible con le batterie della linea POWER 21 V.
Compatible con baterías de la línea POWER 21 V.
Kompatibel mit POWER 21 V Batterien.
Compatible with batteries of the POWER 21 V line.



- ① Ricambi
- Ⓔ Recambios
- Ⓓ Ersatzteile
- Ⓞ Spare parts

Art. 318, 618

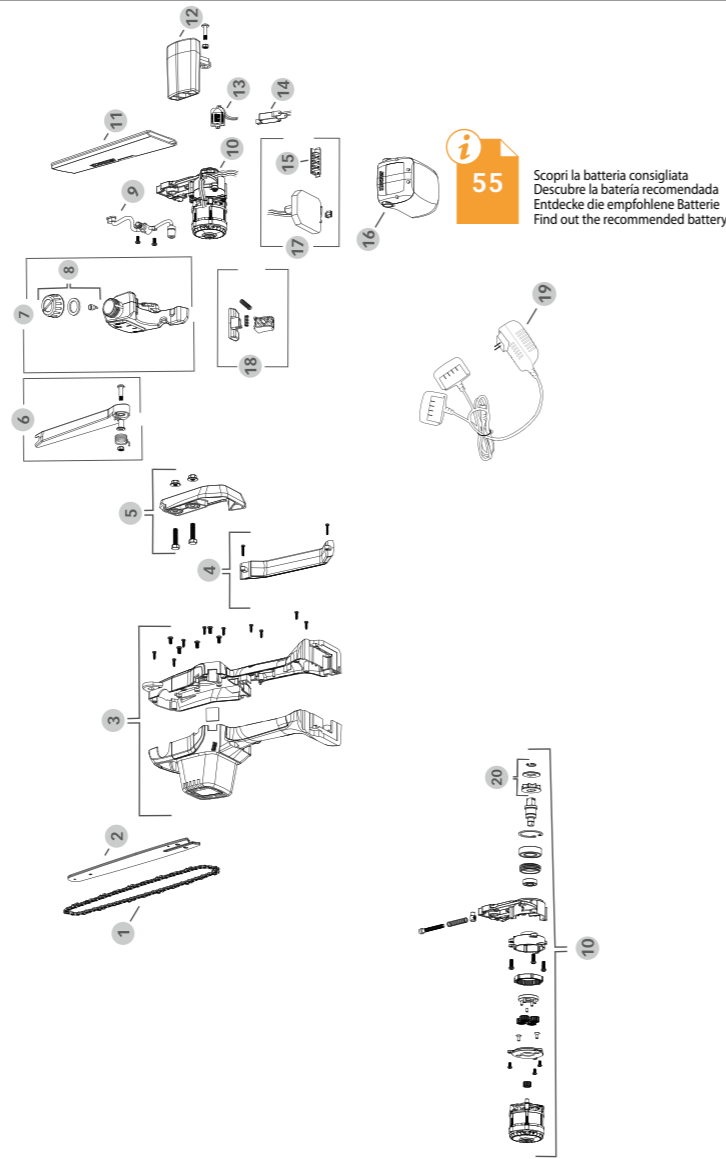

#	Art.	IT	ES	DE	EN	€
1	318/1	Catena 47 denti 1/4" 1,1 mm	Cadena 47 dientes 1/4" 1,1 mm	Kette 47 Zähne 1/4" 1,1 mm	Chain 47 teeth 1/4" 1,1 mm	22,60-
2	318/2	Spranga 24,5 cm / 8"	Barra guía 24,5 cm / 8"	Schwert 24,5 cm / 8"	Guide bar 24,5 cm / 8"	16,65-
3	318/3	Set copertura per motosega	Juego de fundas para motosierras	Abdeckungssset für elektrische Motorsäge	Cover set for chainsaws	20,55-
4	318/4	Protezione mano	Protección para manos	Handschutz	Hand protection	4,00-
5	318/5	Coperchio roccetto catena	Tapa del piñón de cadena	Kettenradabdeckung	Chain sprocket cover	8,35-
6	318/6	Copertura protettiva 24,5 cm / 8"	Capa protectora flexible 24,5 cm / 8"	Flexible Schutzhülse 24,5 cm / 8"	Protective cover 24,5 cm / 8"	2,70-
7	318/7	Tanica olio lubrificante catena con tappo	Contenedor para aceite lubricante de cadena con tapón	Tank für Kettenöl mit Deckel	Chain lubricating oil tank with cap	6,70-
8	318/8	Tappo tanica olio lubrificante catena	Tapón tanque de aceite lubricante de cadena	Deckel für Kettenöltank	Chain lubricating oil tank cap	2,10-
9	318/9	Pompa olio lubrificante catena con tubi di mandata	Bomba de aceite lubricante de cadena con tubos de entrada	Kettenölpumpe mit Verbindungsschlauch	Chain lubricating oil pump with delivery pipes	13,50-
10	318/10	Motoriduttore con attacco per lama	Motorreductor con conexión para hojas	Reduziergetriebe mit Motor	Geared motor with connection for blade	128,00-
11	318/11	Fodero catena 24,5 cm / 8"	Funda cadena 24,5 cm / 8"	Transportschutz für Schwert 24,5 cm / 8"	Chain sheath 24,5 cm / 8"	3,00-
12	318/12	Impugnatura	Empuñadura	Griff	Handle	12,75-
13	316/9	Display LED	Pantalla LED	LED Display	Display LED	9,15-
14	316/8	Interruttore	Interruptor	Ein-/Aus-Schalter	Power button	2,10-
15	316/11	Contatti per batteria	Contactos batería	Batteriekontakte	Battery contacts	2,10-
17	316/10	Circuito stampato con contatti batteria	Circuito impreso con contactos batería	Leiterplatte mit Batteriekontakte	Printed circuit board with battery contacts	46,00-
18	316/7	Grilletto e tasto di sicurezza	Gatillo y botón de seguridad	Auslöser und Sperrschalter	Trigger with safety button	1,25-
19	312/8	Caricabatterie doppio 21 V	Cargador doble 21 V	Zweifach-Ladegerät 21 V	Double battery charger 21 V	27,05-
	318/13	Kit viti completo	Kit tornillos completo	Kit Schrauben komplett	Complete screws kit	5,00-
	318/14	Valigetta per motosega Magma	Maletín para motosierra Magma	Koffer für Motorsäge Magma	Suitcase for chainsaw Magma	25,65-
	318/15	Pignone con rondella	Piñón con arandela	Ritzel mit Unterlegscheibe	Sprocket with washer	8,75-
16	312/7	Batteria Power 21 V 2,6 Ah	Batería Power 21 V 2,6 Ah	Batterie Power 21 V 2,6 Ah	Battery Power 21 V 2,6 Ah	73,50-
16	325	Batteria Power 21 V 4,0 Ah	Batería Power 21 V 4,0 Ah	Batterie Power 21 V 4,0 Ah	Battery Power 21 V 4,0 Ah	118,00-
16	328	Batteria Power 21 V 8,0 Ah	Batería Power 21 V 8,0 Ah	Batterie Power 21 V 8,0 Ah	Battery Power 21 V 8,0 Ah	203,00-

21 V POWER LINE
Stocker

Compatible con le batterie della linea POWER 21 V.
Compatible con baterías de la línea POWER 21 V.
Kompatibel mit POWER 21 V Batterien.
Compatible with batteries of the POWER 21 V line.



- ① Ricambi
- Ⓔ Recambios
- Ⓓ Ersatzteile
- Ⓞ Spare parts

Art. 619

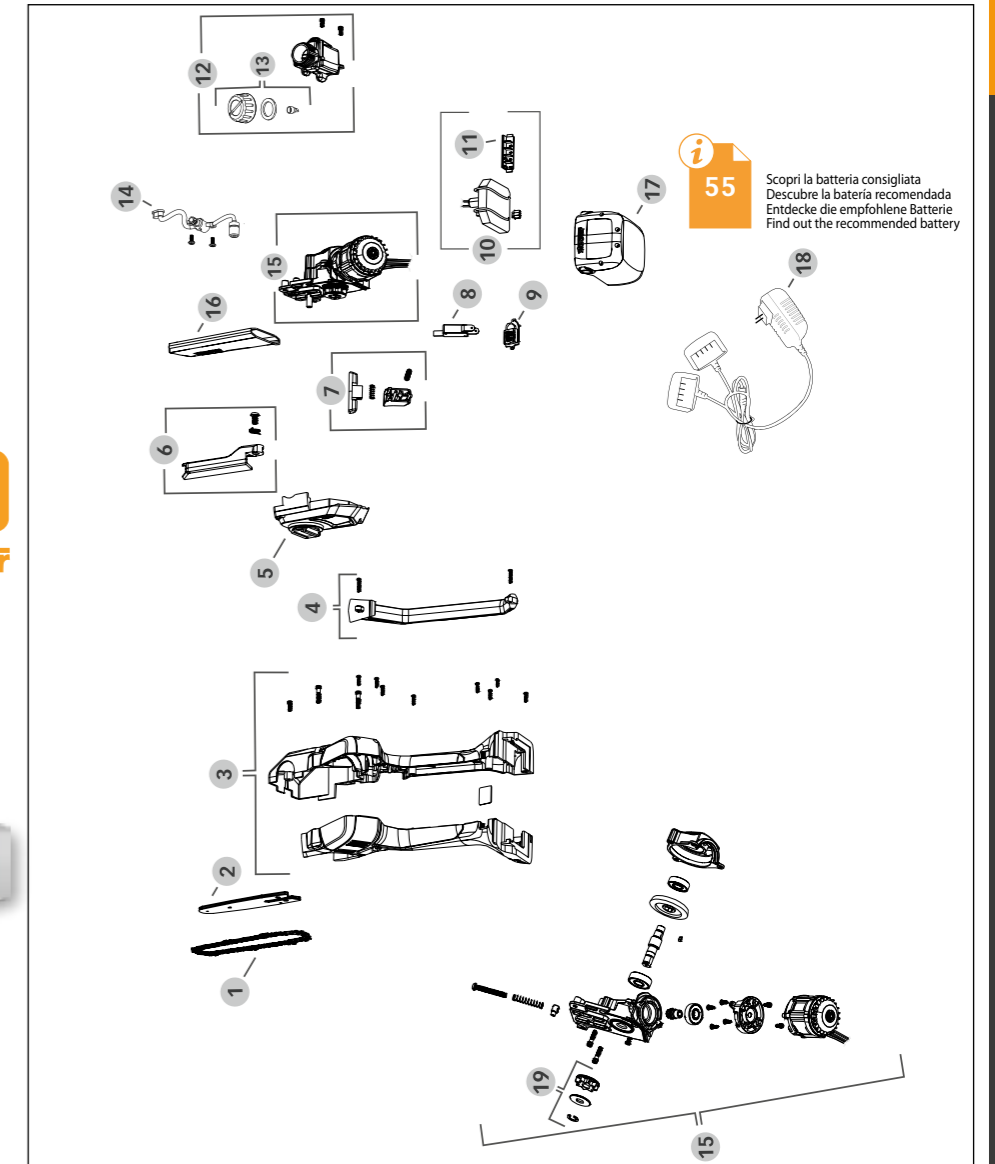

#	Art.	IT	ES	DE	EN	€
1	317/1	Catena 37 denti 1/4" 1,1 mm	Cadena 37 dientes 1/4" 1	Kette 37 Zähne 1/4" 1	Chain 37 teeth 1/4" 1,1 mm	19,15-
2	317/2	Spranga 18,5 cm / 6"	Barra 18,5 cm / 6"	18,5 cm / 6" Stange	Guide bar 18,5 cm / 6"	13,05-
3	619/1	Set copertura per motosega	Juego de fundas para motosierras	Abdeckungssset für elektrische Motorsäge	Cover set for chainsaws	14,50-
4	316/4	Protezione mano	Protección de la mano	Handschutz	Hand protection	4,00-
5	619/2	Coperchio roccetto catena	Tapa del piñón de cadena	Kettenradabdeckung	Chain sprocket cover	3,20-
6	317/3	Copertura protettiva 18,5 cm / 6"	Cubierta protectora 18	Schutzhülle 18	Protective cover 18,5 cm / 6"	1,55-
7	316/7	Grilletto e tasto di sicurezza	Gatillo y botón de seguridad	Abzug und Sicherheitsknopf	Trigger with safety button	1,25-
8	316/8	Interruttore	Interruptor	Schalter	Power button	2,10-
9	316/9	Display LED	Pantalla LED	LED-Anzeige	Display LED	9,15-
10	316/10	Circuito stampato con contatti batteria	Placa de circuito impreso con contactos de batería	Leiterplatte mit Batteriekontakten	Printed circuit board with battery contacts	46,00-
11	316/11	Contatti per batteria	Contactos para batería	Batteriekontakte	Battery contacts	2,10-
12	619/7	Tanica olio lubrificante catena con tappo	Contenedor para aceite lubricante de cadena con tapón	Tank für Kettenöl mit Deckel	Chain lubricating oil tank with cap	6,65-
13	318/8	Tappo tanica olio lubrificante catena	Tapón tanque de aceite lubricante de cadena	Deckel für Kettenöltank	Chain lubricating oil tank cap	2,10-
14	619/3	Pompa olio lubrificante catena con tubi di mandata	Bomba de aceite lubricante de cadena con tubos de entrada	Kettenölpumpe mit Verbindungsschlauch	Chain lubricating oil pump with delivery pipes	14,95-
15	619/4	Motoriduttore con attacco per lama	Motorreductor con conexión para hojas	Reduziergetriebe mit Motor	Geared motor with connection for blade	101,50-
16	317/4	Fodero catena 18,5 cm / 6"	Protector de cadena 18	Kettenscheide 18	Chain sheath 18,5 cm / 6"	2,50-
18	312/8	Caricabatterie doppio 21 V	Cargador doble 21 V	Zweifach-Ladegerät 21 V	Double battery charger 21 V	27,05-
19	619/5	Pignone con rondella	Piñón con arandela	Ritzel mit Unterlegscheibe	Main Gear	7,50-
	619/6	Kit viti completo	Kit tornillos completo	Kit Schrauben komplett	Complete screws kit	5,15-
17	312/7	Batteria Power 21 V 2,6 Ah	Batería Power 21 V 2,6 Ah	Batterie Power 21 V 2,6 Ah	Battery Power 21 V 2,6 Ah	73,50-
17	325	Batteria Power 21 V 4,0 Ah	Batería Power 21 V 4,0 Ah	Batterie Power 21 V 4,0 Ah	Battery Power 21 V 4,0 Ah	118,00-
17	328	Batteria Power 21 V 8,0 Ah	Batería Power 21 V 8,0 Ah	Batterie Power 21 V 8,0 Ah	Battery Power 21 V 8,0 Ah	203,00-

21 V POWER LINE

Stocker

Compatibile con le batterie della linea POWER 21 V.
Compatible con baterías de la línea POWER 21 V.
Kompatibel mit POWER 21 V Batterien.
Compatible with batteries of the POWER 21 V line.



- Ⓡ Ricambi**
- Ⓛ Recambios**
- Ⓚ Ersatzteile**
- Ⓛ Spare parts**

Art. 316, 317, 616, 617

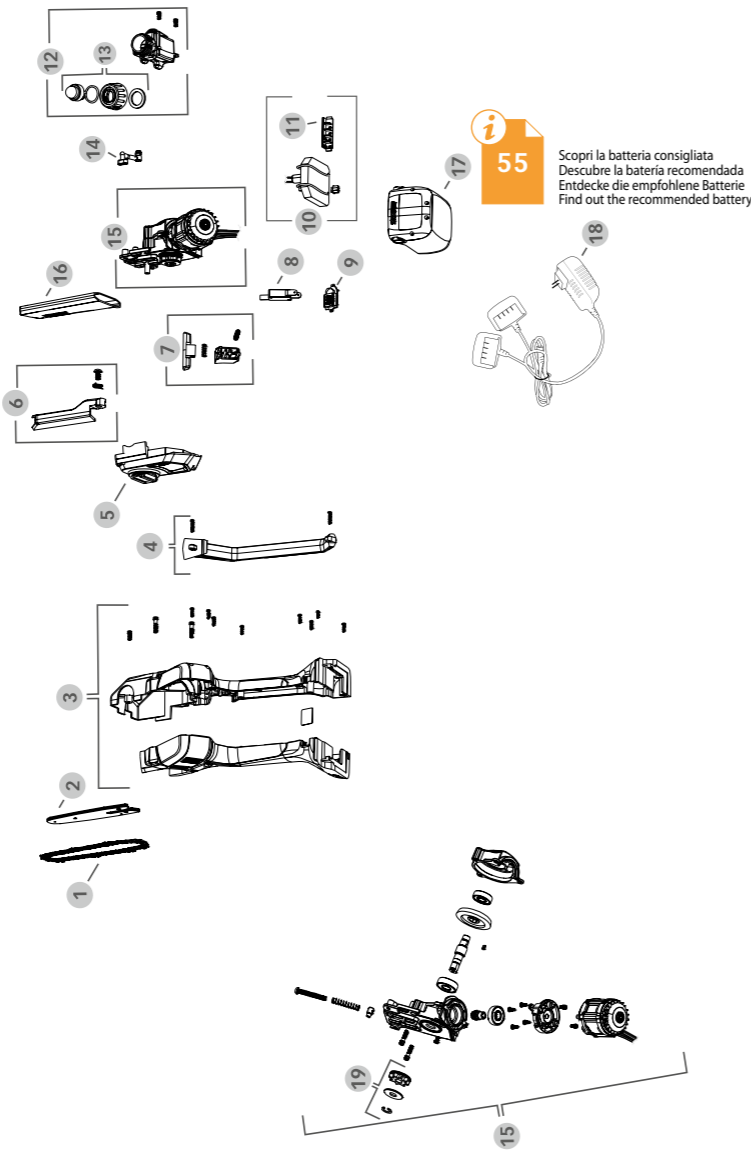

#	Art.	IT	ES	DE	EN	€
1	316/1	Catena 28 denti 1/4" 1,1 mm (Art. 316)	Cadena 28 dientes 1/4" 1,1 mm (Art. 316)	Kette 28 Zähne 1/4" 1,1 mm (Art. 316)	Chain 28 teeth 1/4" 1,1 mm (Item. 316)	16,50-
1	317/1	Catena 37 denti 1/4" 1,1 mm (Art. 317)	Cadena 37 dientes 1/4" 1,1 mm (Art. 317)	Kette 37 Zähne 1/4" 1,1 mm (Art. 317)	Chain 37 teeth 1/4" 1,1 mm (Item. 317)	19,15-
2	316/2	Spranga 13 cm / 4" (Art. 316)	Barra guía 13 cm / 4" (Art. 316)	Schwert 13 cm / 4" (Art. 316)	Guide bar 13 cm / 4" (Item. 316)	10,00-
2	317/2	Spranga 18,5 cm / 6" (Art. 317)	Barra guía 18,5 cm / 6" (Art. 317)	Schwert 18,5 cm / 6" (Art. 317)	Guide bar 18,5 cm / 6" (Item. 317)	13,05-
3	316/3	Set copertura per motosega	Juego de fundas para motosierras	Abdeckungset für elektrische Motorsäge	Cover set for chainsaws	14,80-
4	316/4	Protezione mano	Protección para manos	Handschutz	Hand protection	4,00-
5	316/5	Coperchio roccetto catena	Tapa del piñón de cadena	Kettenradabdeckung	Chain sprocket cover	3,15-
6	316/6	Copertura protettiva 13 cm / 4" (Art. 316)	Capa protectora flexible 13 cm / 4" (Art. 316)	Flexible Schutzhülse 13 cm / 4" (Art. 316)	Protective cover 13 cm / 4" (Item. 316)	1,65-
6	317/3	Copertura protettiva 18,5 cm / 6" (Art. 317)	Capa protectora flexible 18,5 cm / 6" (Art. 317)	Flexible Schutzhülse 18,5 cm / 6" (Art. 317)	Protective cover 18,5 cm / 6" (Item. 317)	1,55-
7	316/7	Grilletto e tasto di sicurezza	Gatillo y botón de seguridad	Auslöser und Sperrschalter	Trigger with safety button	1,25-
8	316/8	Interruttore	Interruptor	Ein-/Aus-Schalter	Power button	2,10-
9	316/9	Display LED	Pantalla LED	LED Display	Display LED	9,15-
10	316/10	Circuito stampato con contatti batteria	Circuito impreso con contactos batería	Leiterplatte mit Batteriekontakte	Printed circuit board with battery contacts	46,00-
11	316/11	Contatti per batteria	Contactos batería	Batteriekontakte	Battery contacts	2,10-
12	316/12	Tanica olio lubrificante catena con tappo	Contenedor para aceite lubricante de cadena con tapón	Tank für Kettenöl mit Deckel	Chain lubricating oil tank with cap	6,65-
13	316/13	Tappo tanica olio lubrificante catena con pompante	Tapón del contenedor de aceite lubricante de cadena con bombeo	Deckel für Kettenöltank mit Pumpe	Chain lubricating oil tank cap with pump	2,90-
14	316/14	Tubo di mandata olio lubrificante catena	Tubo de suministro de aceite lubricante de cadena	Verbindungsschlauch für Kettenöltank	Chain lubricating oil delivery pipe	1,35-
15	316/15	Motoriduttore con attacco per lama	Motorreductor con conexión para hoja	Reduziergetriebe mit Motor	Geared motor with connection for blade	92,00-
16	316/16	Fodero catena 13 cm / 4" (Art. 316)	Funda cadena 13 cm / 4" (Art. 316)	Transportschutz für Schwert 13 cm / 4" (Art. 316)	Chain sheath 13 cm / 4" (Item. 316)	2,25-
16	317/4	Fodero catena 18,5 cm / 6" (Art. 317)	Funda cadena 18,5 cm / 6" (Art. 317)	Transportschutz für Schwert 18,5 cm / 6" (Art. 317)	Chain sheath 13 cm / 6" (Item. 317)	2,50-
18	312/8	Caricabatterie doppio 21 V	Cargador doble 21 V	Zweifach-Ladegerät 21 V	Double battery charger 21 V	27,05-
316/17		Kit viti completo	Kit tornillos completo	Kit Schrauben komplett	Complete screws kit	5,00-
316/18		Valigetta per motosega Magma	Maletín para motosierra Magma	Koffer für Motorsäge Magma	Suitcase for chainsaw Magma	22,00-
19	316/19	Pignone con rondella	Piñon con arandela	Ritzel mit Unterlegscheibe	Sprocket with washer	8,75-
17	312/7	Batteria Power 21 V 2,6 Ah	Batería Power 21 V 2,6 Ah	Batterie Power 21 V 2,6 Ah	Battery Power 21 V 2,6 Ah	73,50-
17	325	Batteria Power 21 V 4,0 Ah	Batería Power 21 V 4,0 Ah	Batterie Power 21 V 4,0 Ah	Battery Power 21 V 4,0 Ah	118,00-
17	328	Batteria Power 21 V 8,0 Ah	Batería Power 21 V 8,0 Ah	Batterie Power 21 V 8,0 Ah	Battery Power 21 V 8,0 Ah	203,00-

21 V POWER LINE

Stocker

Compatibile con le batterie della linea POWER 21 V.
Compatible con baterías de la línea POWER 21 V.
Kompatibel mit POWER 21 V Batterien.
Compatible with batteries of the POWER 21 V line.



- Ⓡ Ricambi**
- Ⓛ Recambios**- Ⓚ Ersatzteile**
- Ⓛ Spare parts**

Art. 615

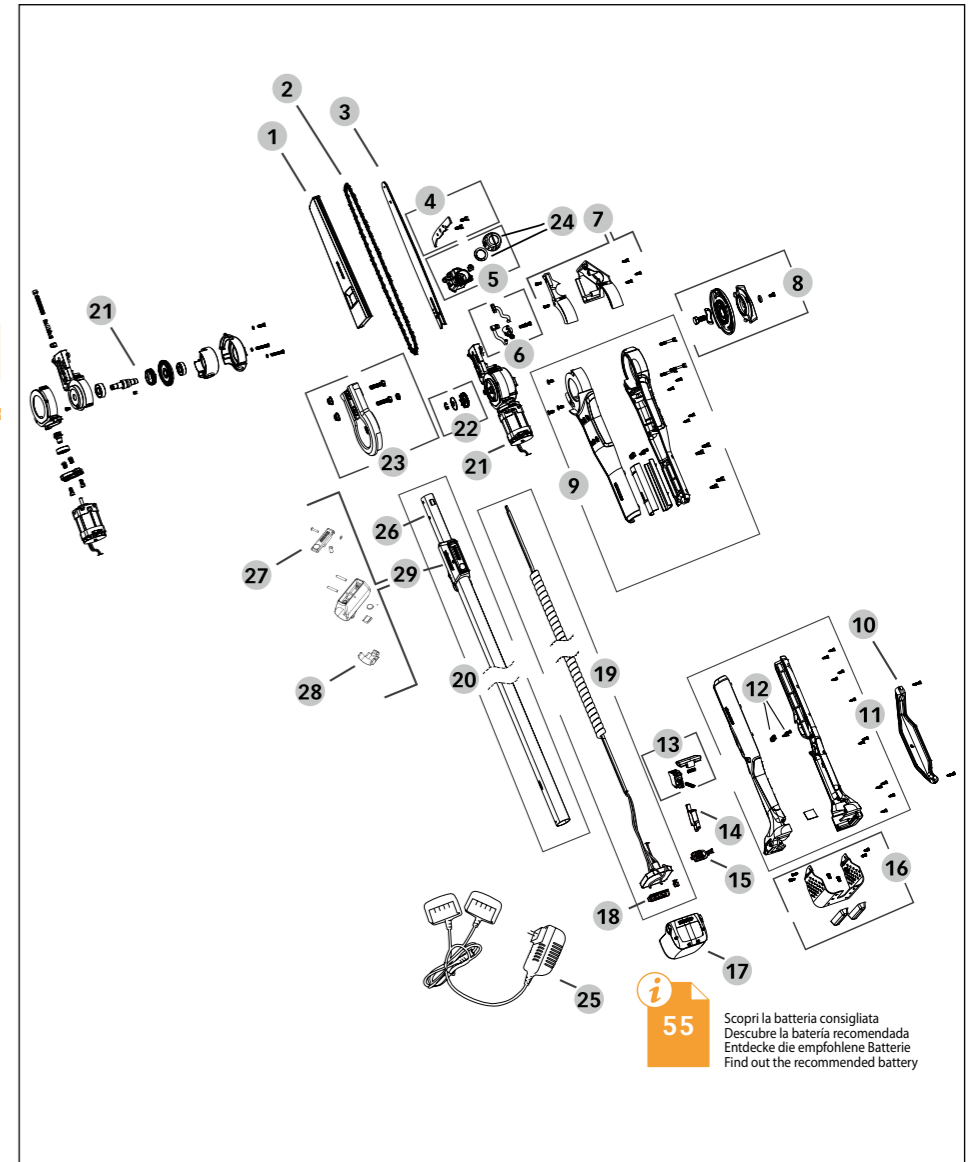

#	Art.	IT	ES	DE	EN	€
2	615/1	Catena 56 denti 1/4" 1,1 mm	Cadena 56 dientes 1/4" 1,1 mm	Kette 56 Zähne 1/4" 1,1 mm	Chain 56 teeth 1/4" 1,1 mm	26,85-
3	615/2	Spranga 29,5 cm / 10"	Barra guía 29,5 cm / 10"	Schwert 29,5 cm / 10"	Guide bar 29,5 cm / 10"	19,15-
7, 9	615/3	Set copertura e copertura di testa per motosega	Set cobertura y cobertura de cabeza para motosierra	Abdeckungset und Kopfabdeckung für elektrische Motorsäge	Cover set and head cover for chainsaws	25,00-
8	615/4	Manopola rotante	Perilla giratoria	Drehknopf	Rotary knob	12,50-
23	615/5	Coperchio roccetto catena	Tapa del piñón de cadena	Kettenradabdeckung	Chain sprocket cover	8,35-
4	615/6	Gancio	Hacken	Hacken	Hook	8,35-
5	615/7	Tanica olio lubrificante catena con tappo	Contenedor para aceite lubricante de cadena con tapón	Tank für Kettenöl mit Deckel	Chain lubricating oil tank with cap	5,00-
6	615/8	Pompa olio lubrificante catena con tubi di mandata	Bomba de aceite lubricante de cadena con tubos de entrada	Kettenölpumpe mit Verbindungsschlauch	Chain lubricating oil pump with delivery pipes	14,00-
21, 6	615/9	Motoriduttore con attacco per lama	Motorreductor con conexión para hojas	Reduziergetriebe mit Motor	Geared motor with connection for blade	134,00-
22	615/10	Pignone con rondella	Piñon con arandela	Ritzel mit Unterlegscheibe	Sprocket with washer	8,35-
19	615/11	Cavo interno a spirale con circuito stampato e contatti per batteria	Cable interno enrollado con circuito impreso y contactos batería	Spiralförmige interne Kabel mit Leiterplatte und Batteriekontakte	Internal coiled cable with printed circuit board and battery contacts	50,00-
26	615/12	Tubo interno	Tubo interno	Innenrohr	Internal tube	17,10-
11, 12	615/13	Set copertura impugnatura	Set cobertura empuñadura	Griffüberzugssatz	Handle cover set	26,25-
10	615/16	Protezione mano	Protección para manos	Handschutz	Hand protection	4,65-
1	615/18	Fodero catena 29,5 cm / 10"	Funda cadena 29,5 cm / 10"	Transportschutz für Schwert 29,5 cm / 10"	Chain sheath 29,5 cm / 10"	3,35-
13	316/7	Grilletto e tasto di sicurezza	Gatillo y botón de seguridad	Auslöser und Sperrschalter	Trigger with safety button	1,25-
14	316/8	Interruttore	Interruptor	Ein-/Aus-Schalter	Power button	2,10-
15	316/9	Display LED	Pantalla LED	LED Display	Display LED	9,15-
18	316/11	Contatti per batteria	Contactos batería	Batteriekontakte	Battery contacts	2,10-
24	318/8	Tappo tanica olio lubrificante catena	Tapón tanque de aceite lubricante de cadena	Deckel für Kettenöltank	Chain lubricating oil tank cap	2,10-
16	580/6	Protezione per batteria fino a 4 Ah	Protección batería hasta 4 Ah	Batterieschutz bis 4 Ah	Battery protection up to 4 Ah	8,20-
16	580/14	Protezione per batteria fino a 8 Ah	Protección batería hasta 8 Ah	Batterieschutz bis 8 Ah	Battery protection up to 8 Ah	11,15-
27	559/2	Pulsante di bloccaggio	Botón de bloqueo	Blockierknopf	Locking button	3,00-
28	565/2	Leva di bloccaggio Profi	Palanca de bloqueo Profi	Blockierknopf Profi	Locking clip Profi	3,00-
29	565/3	Blocco Profi	Bloqueo Profi	Blockiersystem Profi	Profi stopper	9,50-
20	611/2	Tubo esterno con rivestimento antiscivolo (Art. 611)	Tubo externo con revestimiento antideslizante (Art. 611)	Außenrohr mit Antirutschbelag (Art. 611)	External tube with non-slip grip (Item 611)	29,50-
25	312/8	Caricabatterie doppio 21 V	Cargador doble 21 V	Zweifach-Ladegerät 21 V	Double battery charger 21 V	27,05-
-	615/17	Kit viti completo	Kit tornillos completo	Kit Schrauben komplett	Complete screws kit	9,50-
17	312/7	Batteria Power 21 V 2,6 Ah	Batería Power 21 V 2,6 Ah	Batterie Power 21 V 2,6 Ah	Battery Power 21 V 2,6 Ah	73,50-
17	325	Batteria Power 21 V 4,0 Ah	Batería Power 21 V 4,0 Ah	Batterie Power 21 V 4,0 Ah	Battery Power 21 V 4,0 Ah	118,00-
17	328	Batteria Power 21 V 8,0 Ah	Batería Power 21 V 8,0 Ah	Batterie Power 21 V 8,0 Ah	Battery Power 21 V 8,0 Ah	203,00-

21 V POWER LINE

Stocker

Compatibile con le batterie della linea POWER 21 V.
Compatible con baterías de la línea POWER 21 V.
Kompatibel mit POWER 21 V Batterien.
Compatible with batteries of the POWER 21 V line.



- Ⓘ Ricambi
- Ⓔ Recambios
- Ⓓ Ersatzteile
- Ⓒ Spare parts

Art. 614

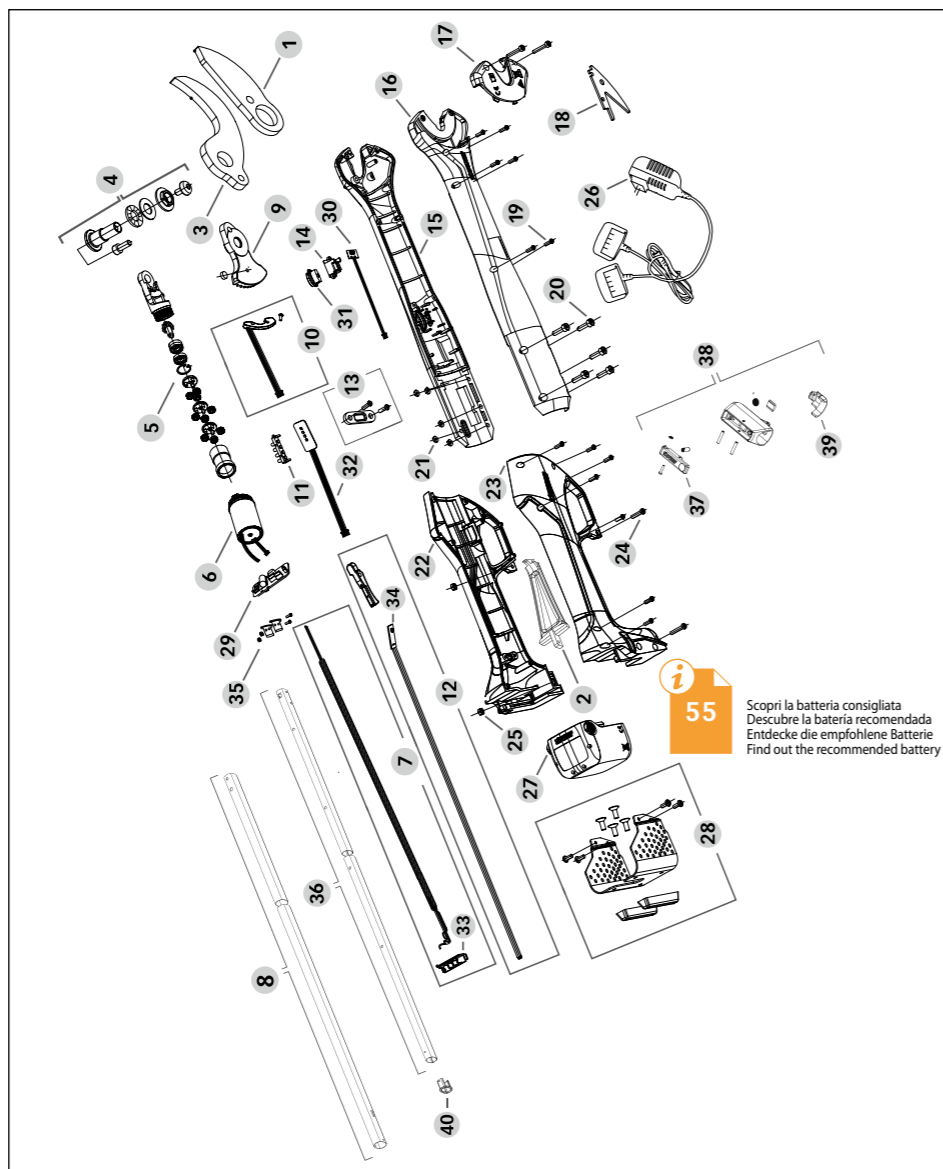

55

Scopri la batteria consigliata
Descubre la batería recomendada
Entdecke die empfohlene Batterie
Find out the recommended battery

21 V POWER LINE

Stocker

Compatibile con le batterie della linea POWER 21 V.
Compatible con baterías de la línea POWER 21 V.
Kompatibel mit POWER 21 V Batterien.
Compatible with batteries of the POWER 21 V line.



- Ⓘ Ricambi
- Ⓔ Recambios
- Ⓓ Ersatzteile
- Ⓒ Spare parts

Art. 612, 613, 622, 623

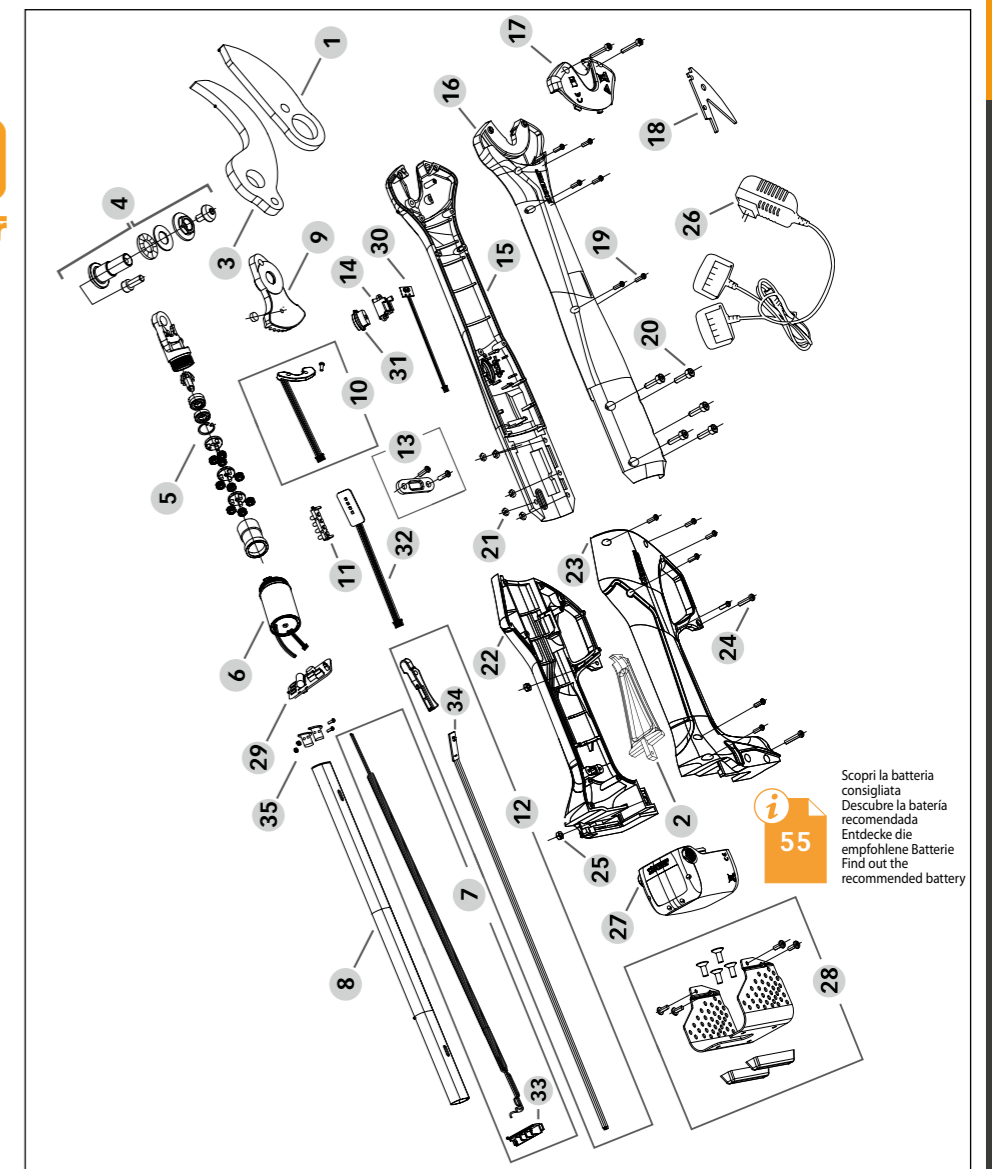

55

Scopri la batteria consigliata
Descubre la batería recomendada
Entdecke die empfohlene Batterie
Find out the recommended battery

#	Art.	IT	ES	DE	EN	€
31	310/6	Interruttore	Interruptor	Ein-/Ausschalter	Power button	1,80
4	312/1	Kit di fissaggio lama	Kit de fijación hoja	Fixier-Kit für Klinge	Fixing blade kit	14,25
1 + 9	312/2	Lama per forbice elettrica	Hoja para tijera eléctrica	Klinge für elektrische Baumschere	Blade for electric shears	29,55
3	312/3	Controlama per forbice elettrica	Contra hoja para tijera eléctrica	Gegenklinge für elektrische Baumschere	Anvil for electric shears	17,85
26	312/8	Caricabatterie doppio 21 V	Cargador doble 21 V	Zweifach-Ladegerät 21 V	Double battery charger 21 V	27,05
5 + 6	612/12	Motoriduttore con attacco per lama	Motorreductor con conexión para hoja	Reduziergetriebe mit Motor	Geared motor with connection for blade	145,50
37	559/2	Pulsante di bloccaggio	Botón de bloqueo	Blockierknopf	Locking button	3,00
39	565/2	Leva di bloccaggio Profi	Palanca de bloqueo Profi	Blockierknopf Profi	Locking clip Profi	3,00
38	565/3	Blocco Profi	Bloqueo Profi	Blockiersystem Profi	Profi stopper	9,50
12	580/11	Grilletto con sensore	Gatillo con sensor	Auslöser mit Sensor	Trigger with sensor	6,75
33	580/12	Contatti per batteria	Contactos batería	Batteriekontakte	Battery contacts	5,80
2 + 13 + 22 + 23 + 24 + 25	580/5	Set copertura per impugnatura	Set cobertura para empuñadura	Abdeckungsset für Griff	Cover for handle set	24,60
28	580/6	Protezione per batteria fino a 4 Ah	Protección batería hasta 4 Ah	Batterieschutz bis 4 Ah	Battery protection up to 4 Ah	8,20
28	580/14	Protezione per batteria fino a 8 Ah	Protección batería hasta 8 Ah	Batterieschutz bis 8 Ah	Battery protection up to 8 Ah	11,15
7 + 34	581/1	Cavo di alimentazione	Cable de alimentación	Kabel	Cable	77,40
8	581/2	Tubo esterno con rivestimento antiscivolo	Tubo externo con revestimiento antideslizante	Außenrohr mit Antirutschbelag	External tube with non-slip grip	31,90
36	581/3	Tubo interno	Tubo interno	Innenrohr	Internal tube	24,25
11 + 15 + 16 + 19 + 20 + 21	612/1	Set copertura anteriore per troncaremi elettrico	Set de tapa frontal para cortarramas eléctrico	Vorderes Abdeckungsset für elektrische Astschere	Front cover for battery lopper	27,50
29 + 30	612/11	Circuito stampato	Circuito impreso	Leiterplatte	Printed circuit board	91,70
17	612/2	Copertura di testa per troncaremi elettrico	Cobertura de cabeza para cortarramas eléctrico	Kopfabdeckung für elektrische Astschere	Head cover for battery lopper	5,40
35	612/4	Fermacavo interno	Abrazadera interna	Kabelhalter	Internal cable holder	6,25
14	612/5	Supporto per interruttore	Soporte para interruptor	Halterung für Ein-/Aus-Schalter	Switch button support	5,00
18	612/6	Gancio	Gancho	Hacken	Hook	11,25
32	612/7	Scheda LED livello batteria	Tablero LED con nivel de batería	LED- Karte für Batterieinspektion	Battery level LED board	23,35
10	612/8	Sensore grilletto superiore	Sensor gatillo superior	Sensor für oberen Auslöser	Upper trigger sensor	16,65
-	612/10	Kit viti completo	Kit tornillos completo	Kit Schrauben komplett	Complete screw set	12,50
40	580/4	Protezione tubo interno per cavo	Protección tubo interno para cable	Interner Rohrschutz für Kabel	Internal tube protection for cable	1,65
27	312/7	Batteria Power 21 V 2,6 Ah	Batería Power 21 V 2,6 Ah	Batterie Power 21 V 2,6 Ah	Battery Power 21 V 2,6 Ah	73,50
27	325	Batteria Power 21 V 4,0 Ah	Batería Power 21 V 4,0 Ah	Batterie Power 21 V 4,0 Ah	Battery Power 21 V 4,0 Ah	118,00
27	328	Batteria Power 21 V 8,0 Ah	Batería Power 21 V 8,0 Ah	Batterie Power 21 V 8,0 Ah	Battery Power 21 V 8,0 Ah	203,00

#	Art.	IT	ES	DE	EN	€
1, 9	312/2	Lama per forbice elettrica	Hoja para tijera eléctrica	Klinge für elektrische Baumschere	Blade for electric shears	29,55
2, 13, 22, 23, 24, 25	580/5	Set copertura per impugnatura	Set cobertura para empuñadura	Abdeckungsset für Griff	Cover for handle set	24,60
3	312/3	Controlama per forbice elettrica	Contra hoja para tijera eléctrica	Gegenklinge für elektrische Baumschere	Anvil for electric shears	17,85
4	312/1	Kit di fissaggio lama	Kit de fijación hoja	Fixier-Kit für Klinge	Fixing blade kit	14,25
5, 6	612/12	Motoriduttore con attacco per lama	Motorreductor con conexión para hoja	Reduziergetriebe mit Motor	Geared motor with connection for blade	145,50
7, 34	612/9	Cavo di alimentazione con connettori batteria e sensore grilletto inferiore (Art.612)	Cable de alimentación con conectores de batería y sensor gatillo inferior (Art.612)	Kabel mit Anschlüssen und Sensor für unteren Auslöser (Art.612)	Power cable with battery connectors and bottom trigger sensor (Art.612)	41,65
7, 34	613/2	Cavo di alimentazione con connettori batteria e sensore grilletto inferiore (Art.613)	Cable de alimentación con conectores de batería y sensor gatillo inferior (Art.613)	Kabel mit Anschlüssen und Sensor für unteren Auslöser (Art.613)	Power cable with battery connectors and bottom trigger sensor (Art.613)	62,50
8	612/3	Tubo con rivestimento antiscivolo (Art.612)	Tubo con revestimiento antideslizante (Art.612)	Rohr mit Antirutschbelag (Art.612)	Aluminum tube with non-slip grip (short) (Art.612)	20,00
8	613/1	Tubo con rivestimento antiscivolo (Art.613)	Tubo con revestimiento antideslizante (Art.613)	Rohr mit Antirutschbelag (Art.613)	Aluminum tube with non-slip grip (long) (Art.613)	22,50
10	612/8	Sensore grilletto superiore	Sensor gatillo superior	Sensor für oberen Auslöser	Upper trigger sensor	16,65
11, 15, 16, 19, 20, 21	612/1	Set copertura anteriore per troncaremi elettrico	Set de tapa frontal para cortarramas eléctrico	Vorderes Abdeckungsset für elektrische Astschere	Front cover for battery lopper	27,50
12	580/11	Grilletto con sensore	Gatillo con sensor	Auslöser mit Sensor	Trigger with sensor	6,75
14	612/5	Supporto per interruttore	Soporte para interruptor	Halterung für Ein-/Aus-Schalter	Switch button support	5,00
17	612/2	Copertura di testa per troncaremi elettrico	Cobertura de cabeza para cortarramas eléctrico	Kopfabdeckung für elektrische Astschere	Head cover for battery lopper	5,40
18	612/6	Gancio	Gancho	Hacken	Hook	11,25
26	312/8	Caricabatterie doppio 21 V	Cargador doble 21 V	Zweifach-Ladegerät 21 V	Double battery charger 21 V	27,05
28	580/6	Protezione per batteria fino a 4 Ah	Protección batería hasta 4 Ah	Batterieschutz bis 4 Ah	Battery protection up to 4 Ah	8,20
28	580/14	Protezione per batteria fino a 8 Ah	Protección batería hasta 8 Ah	Batterieschutz bis 8 Ah	Battery protection up to 8 Ah	11,15
29, 30	612/11	Circuito stampato	Circuito impreso	Leiterplatte	Printed circuit board	91,70
31	310/6	Interruttore	Interruptor	Ein-/Ausschalter	Power button	1,80
32	612/7	Scheda LED livello batteria	Tablero LED con nivel de batería	LED- Karte für Batterieinspektion	Battery level LED board	23,35
33	580/12	Contatti per batteria	Contactos batería	Batteriekontakte	Battery contacts	5,80
35	612/4	Fermacavo interno	Abrazadera interna	Kabelhalter	Internal cable holder	6,25
	612/10	Kit viti completo	Kit tornillos completo	Kit Schrauben komplett	Complete screw set	12,50
27	312/7	Batteria Power 21 V 2,6 Ah	Batería Power 21 V 2,6 Ah	Batterie Power 21 V 2,6 Ah	Battery Power 21 V 2,6 Ah	73,50
27	325	Batteria Power 21 V 4,0 Ah	Batería Power 21 V 4,0 Ah	Batterie Power 21 V 4,0 Ah	Battery Power 21 V 4,0 Ah	118,00
27	328	Batteria Power 21 V 8,0 Ah	Batería Power 21 V 8,0 Ah	Batterie Power 21 V 8,0 Ah	Battery Power 21 V 8,0 Ah	203,00

21 V POWER LINE

Stocker

Compatibile con le batterie della linea POWER 21 V.
Compatible con baterías de la línea POWER 21 V.
Kompatibel mit POWER 21 V Batterien.
Compatible with batteries of the POWER 21 V line.



- ① Ricambi
- Ⓔ Recambios
- Ⓓ Ersatzteile
- Ⓒ Spare parts

Art. 404, 405, 406

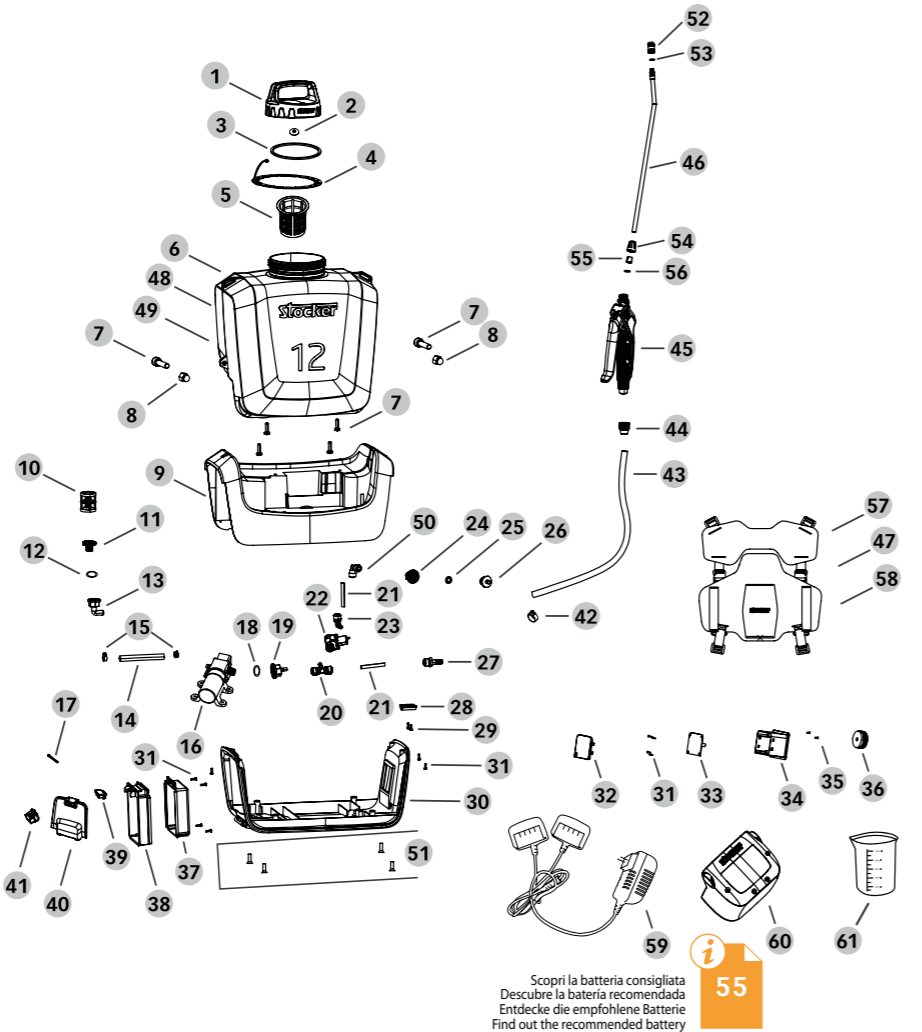

Scopri la batteria consigliata
Descubre la batería recomendada
Entdecke die empfohlene Batterie
Find out the recommended battery

55



#	Art.	IT	ES	DE	EN	€
6	404/1	Serbatoio 12 L	Tanque 12 L	Tank 12 L	Tank 12 L	26,35-
48	405/1	Serbatoio 15 L	Tanque 15 L	Tank 15 L	Tank 15 L	28,55-
49	406/1	Serbatoio 20 L	Tanque 20 L	Tank 20 L	Tank 20 L	31,70-
47	404/2	Bastino per pompa da 12 L	Portador para bomba de 12 L	Schultergurt für Rückenspritze zu 12 L	Shoulder harness for 12 L sprayer	37,65-
57	405/2	Bastino per pompa da 15 L	Portador para bomba de 15 L	Schultergurt für Rückenspritze zu 15 L	Shoulder harness for 15 L sprayer	39,10-
58	406/2	Bastino per pompa da 20 L	Portador para bomba de 20 L	Schultergurt für Rückenspritze zu 20 L	Shoulder harness for 20 L sprayer	41,05-
1 + 2 + 3 + 4 + 5	226/2	Chiusura serbatoio (Tappo, filtro e guarnizione)	Cierre tanque (Tapón, filtro y junta)	Verschluss Tank (Verschluss, Filter und Dichtung)	Tank cap (Cap, filter and seal)	6,60-
16 + 18 + 19	404/3	Motore	Motor	Motor	Motor	48,45-
4x31 + 32 + 33 + 34 + 2x35 + 36	404/4	Display di comando	Pantalla de control	Kontrolldisplay	Control display	19,00-
30 + 9 + 41 + 40 + 17 + 28 + 2x29 + 6x7 + 2x8 + 6x51 + 4x31	404/5	Base serbatoio	Base tanque	Tankbasis	Tank base	19,55-
15 + 2x14	404/6	Tubo mandata serbatoio	Tubo entrada tanque	Tank-Verbindungsschlauch	Tank delivery hose	3,05-
37 + 38 + 39 + 4x31	404/7	Scatola batteria e contatti	Caja de batería y contactos	Batteriekasten und Kontakte	Battery box and contacts	10,70-
39	404/8	Contatti per batteria con cavo	Contactos batería con cable	Batteriekontakte mit Kabel	Battery contacts with cable	8,15-
18 + 19 + 20 + 21x2 + 23 + 50 + 27 + 28	404/9	Raccorderia interna	Guarniciones internas	Interne Beschläge	Internal fittings	8,50-
27 + 42 + 43 + 44 + 45 + 56 + 55 + 54 + 46 + 53 + 52	404/10	Lancia in fibra di vetro con tubo, impugnatura, ugello e guarnizioni in FPM	Lanza de fibra de vidrio con tubo, empuñadura, boquillas y juntas de FPM	Fiberglas-Sprühlanze mit Schlauch, Griff, Düse und FPM-Dichtungen	Fiberglass lance with handle, tube, nozzle and FPM-seals	15,25-
27 + 42 + 43 + 2x44 + 45	404/11	Tubo e impugnatura con guarnizioni in FPM	Tubo y empuñadura con juntas de FPM	Schlauch und Griff mit FPM-Dichtung	Tube and handle with FPM-seals	19,00-
6x51 + 12x31 + 2x35 + 2x29 + 6x7 + 2x8	404/12	Set viti	Set tornillos	Schraubenset	Screws set	7,65-
18 + 12 + 25 + 3 + 2 + 56 + 53	404/13	Set guarnizione	Set junta	Dichtungset	Seal set	14,30-
45 + 44	404/14	Impugnatura	Empuñadura	Griff	Handle	12,40-
10 + 11 + 12 + 13	410/14	Filtro	Filtro	Filter	Filter	2,30-
24 + 25 + 26	414/8	Ugello interno di miscelazione	Boquilla interna de mezcla	Interne Mischdüse	Internal mixing nozzle	4,15-
22	404/15	Valvola elettrica	Válvula eléctrica	Elektrisches Ventil	Electric valve	16,25-
43 + 42 + 27	404/16	Tubo	Tubo	Schlauch	Pipe	4,75-
59	312/8	Caricabatterie doppio 21 V	Cargador doble 21 V	Zweifach-Ladegerät 21 V	Double battery charger 21 V	27,05-
61	237/17	Misurino dosatore graduato	Vaso medidor graduado	Messbecher mit Maßanzeige	Graduated measuring cup	0,70-
60	312/7	Batteria Power 21 V 2,6 Ah	Batería Power 21 V 2,6 Ah	Batterie Power 21 V 2,6 Ah	Battery Power 21 V 2,6 Ah	73,50-
60	325	Batteria Power 21 V 4,0 Ah	Batería Power 21 V 4,0 Ah	Batterie Power 21 V 4,0 Ah	Battery Power 21 V 4,0 Ah	118,00-
60	328	Batteria Power 21 V 8,0 Ah	Batería Power 21 V 8,0 Ah	Batterie Power 21 V 8,0 Ah	Battery Power 21 V 8,0 Ah	203,00-

21 V POWER LINE

Stocker

Compatibile con le batterie della linea POWER 21 V.
Compatible con baterías de la línea POWER 21 V.
Kompatibel mit POWER 21 V Batterien.
Compatible with batteries of the POWER 21 V line.



- ① Ricambi
- Ⓔ Recambios
- Ⓓ Ersatzteile
- Ⓒ Spare parts

Art. 434

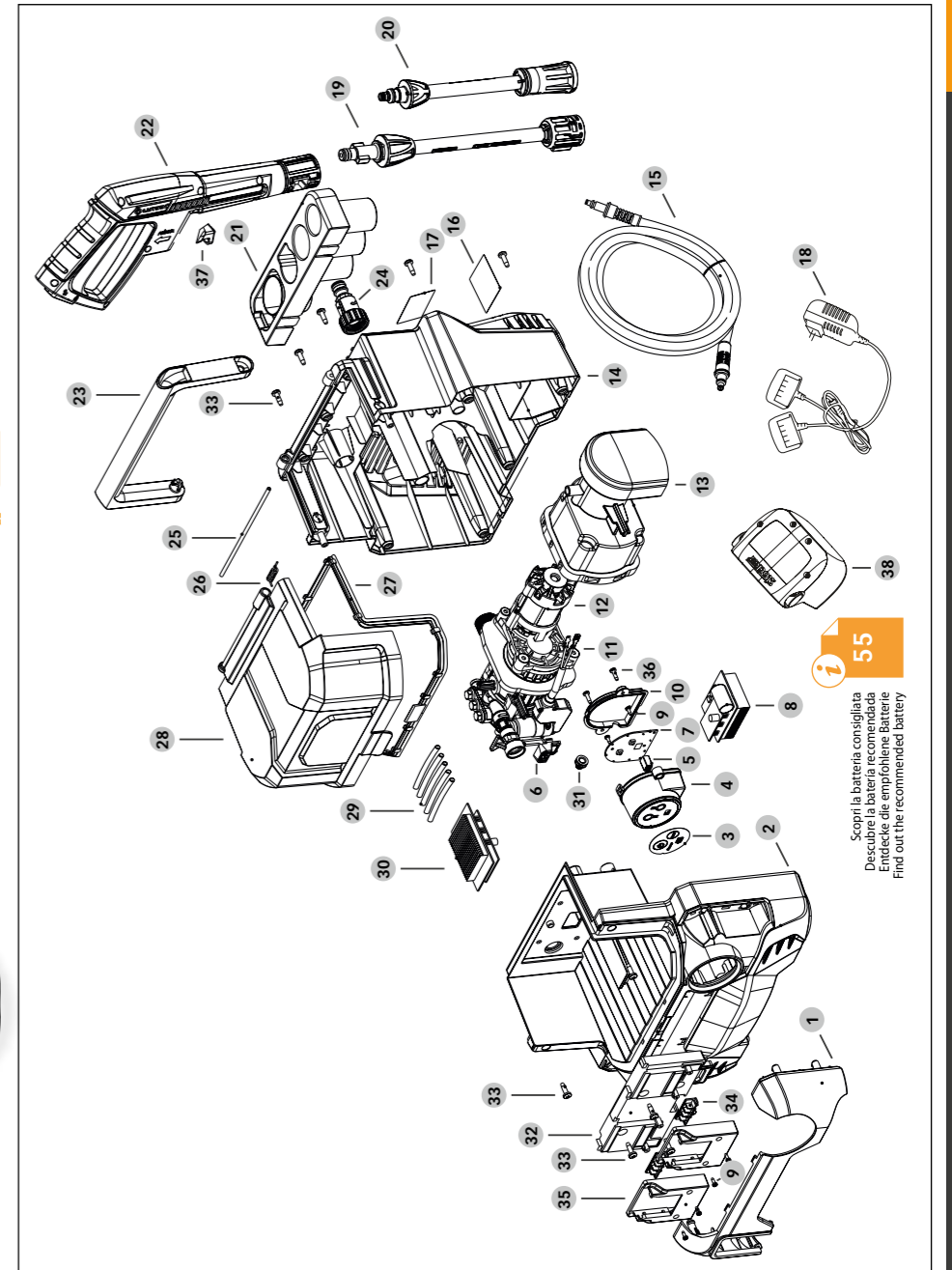

55

Scopri la batteria consigliata
Descubre la batería recomendada
Entdecke die empfohlene Batterie
Find out the recommended battery

#	Art.	IT	ES	DE	EN	€
19 + 20	433/1	Lancia con ugello regolabile	Lanza con boquilla ajustable	Lanze mit verstellbarer Düse	Lance with adjustable nozzle	8,60-
15	434/1	Tubo alta pressione 10 m	Manguera de alta presión de 10 m	Hochdruckschlauch 10 m	10 m high pressure hose	23,30-
22	434/2	Pistola idropulitrice	Pistola Hidrolimpiadora	Hochdruckpistole	Pressure Washer Gun	11,70-
1 + 2 + 6 + 14 + 16 + 17 + 33x10	434/3	Set copertura	Set de tapa	Abdeckungsset	Cover set	35,80-
25 + 26 + 28	434/4	Coperchio alloggiamento batteria	Tapa del alojamiento de la batería	Abdeckung des Batteriegehäuses	Battery housing cover	10,60-
27	434/5	Guarnizione coperchio alloggiamento batteria	Junta tapa alojamiento de la batería	Dichtung des Batteriegehäusedeckels	Battery housing cover seal	3,80-
23	434/6	Maniglia per trasporto	Manija de transporte	Tragegriff	Carrying handle	4,80-
21	434/7	Alloggiamento accessori	Alojamiento accesorios	Halterung für Zubehör	Accessory housing	5,45-
9x4 + 32 + 33x4 + 34x2 + 35x2	434/8	Alloggiamento batteria con contatti	Carcasa de la batería con contactos	Batteriegehäuse mit Kontakten	Battery housing with contacts	10,55-
24	434/9	Raccordo rapido con filtro	Acoplamiento rápido con filtro	Schlauch-Schnellanschluss mit Filter	Quick connector with filter	2,90-
3 + 4 + 5 + 7 + 9x2 + 10 + 36x2	434/10	Pannello di comando completo	Panel de control completo	Bedienfeld	Control panel	20,65-
29x5 + 30 + 31	434/11	Scheda di controllo elettronica	Tablero de control electrónico	Elektronische Steuerplatine	Electronic control board	16,75-
11 + 12 + 13 + 32x5	434/12	Motore con pompa	Motor con bomba	Motor mit Pumpe	Engine with pump	115,00-
6 + 9x6 + 33x14 + 36x2 + 37	434/13	Set viti	Set tornillos	Schraubenset	Screws set	2,65-
18	312/8	Caricabatterie doppio 21 V	Cargador doble 21 V	Zweifach-Ladegerät 21 V	Double battery charger 21 V	27,05-
38	312/7	Batteria Power 21 V 2,6 Ah	Batería Power 21 V 2,6 Ah	Batterie Power 21 V 2,6 Ah	Battery Power 21 V 2,6 Ah	73,50-
38	325	Batteria Power 21 V 4,0 Ah	Batería Power 21 V 4,0 Ah	Batterie Power 21 V 4,0 Ah	Battery Power 21 V 4,0 Ah	118,00-
38	328	Batteria Power 21 V 8,0 Ah	Batería Power 21 V 8,0 Ah	Batterie Power 21 V 8,0 Ah	Battery Power 21 V 8,0 Ah	203,00-

21 V POWER LINE

Stocker

Compatibile con le batterie della linea POWER 21 V.
Compatible con baterías de la línea POWER 21 V.
Kompatibel mit POWER 21 V Batterien.
Compatible with batteries of the POWER 21 V line.



- Ⓛ Ricambi
- Ⓔ Recambios
- Ⓓ Ersatzteile
- Ⓞ Spare parts

Art. 433

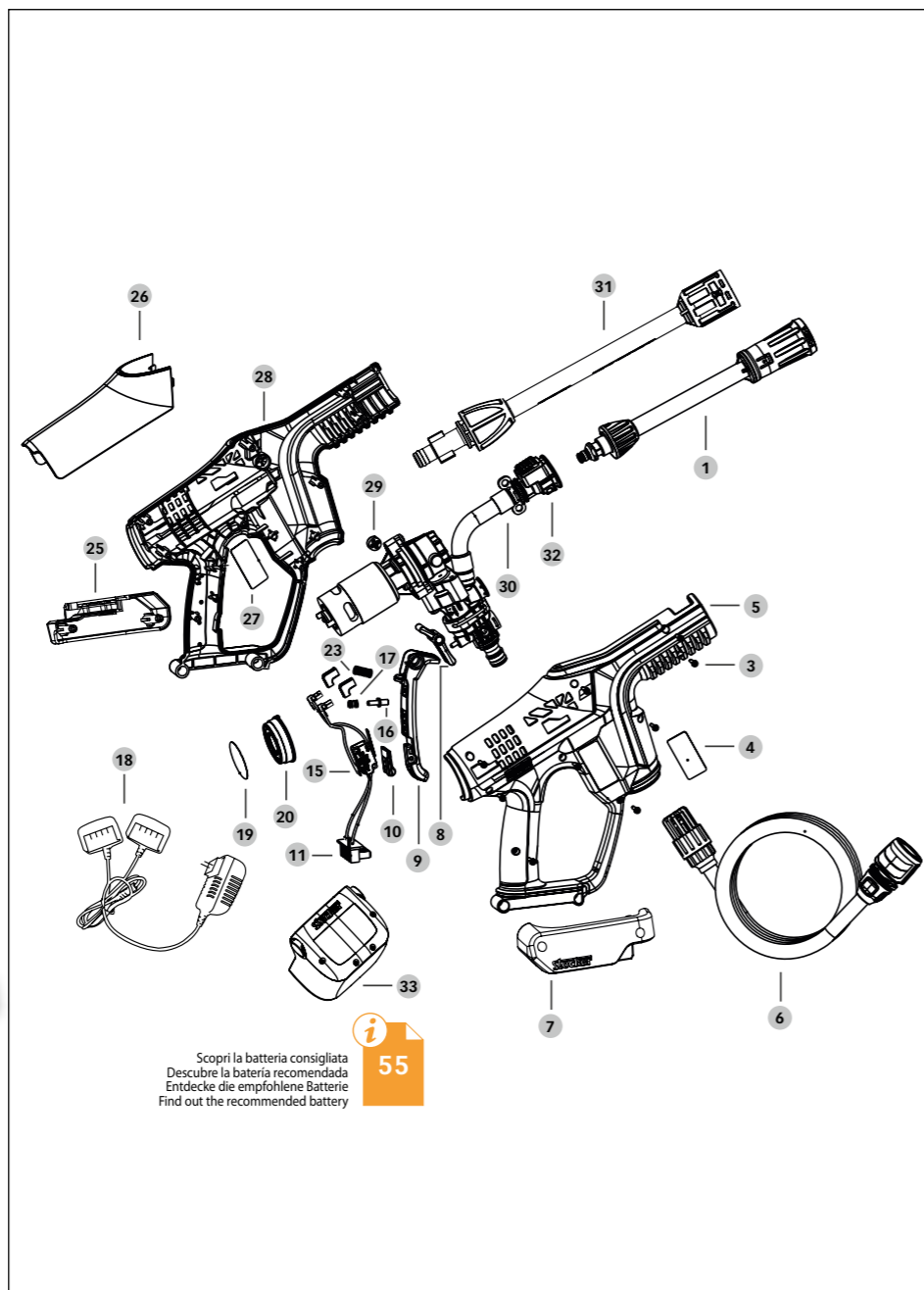

Scopri la batteria consigliata
Descubre la batería recomendada
Entdecke die empfohlene Batterie
Find out the recommended battery



#	Art.	IT	ES	DE	EN	€
1 + 31	433/1	Lancia con ugello regolabile	Lanza con boquilla ajustable	Lanze mit verstellbarer Düse	Lance with adjustable nozzle	8,60-
6	433/2	Tubo aspirazione 5 m con filtro e raccordo rapido	Manguera de aspiración de 5 m con filtro y conector rápido	Hochdruckschlauch 5 m mit Filter und Schnellanschluss	5 m vacuum hose with filter and quick hose connector	12,25-
3x9 + 4 + 5 + 19 + 20 + 26 + 27 + 28	433/3	Set copertura	Set de tapa	Abdeckungsset	Cover set	23,35-
3x27 + 11 + 25	433/4	Alloggiamento batteria con contatti	Carcasa de la batería con contactos	Batteriegehäuse mit Kontakten	Battery housing with contacts	9,70-
8 + 9 + 10 + 16 + 17 + 23	433/5	Grilletto	Gatillo	Auslöser	Trigger	5,20-
29 + 30	433/6	Motore con pompa	Motor con bomba	Motor mit Pumpe	Engine with pump	71,30-
32	433/7	Attacco per lancia	Fijación de lanza	Halterung Lanze	Lance attachment	5,15-
15	433/8	Interruttore	Interruptor	Ein-/Aus-Schalter	Power button	2,85-
3x11 + 16 + 17 + 23	433/9	Set viti	Set tornillos	Schraubenset	Screws set	3,40-
18	312/8	Caricabatterie doppio 21 V	Cargador doble 21 V	Zweifach-Ladegerät 21 V	Double battery charger 21 V	27,05-
33	312/7	Batteria Power 21 V 2,6 Ah	Batería Power 21 V 2,6 Ah	Batterie Power 21 V 2,6 Ah	Battery Power 21 V 2,6 Ah	73,50-
33	325	Batteria Power 21 V 4,0 Ah	Batería Power 21 V 4,0 Ah	Batterie Power 21 V 4,0 Ah	Battery Power 21 V 4,0 Ah	118,00-
33	328	Batteria Power 21 V 8,0 Ah	Batería Power 21 V 8,0 Ah	Batterie Power 21 V 8,0 Ah	Battery Power 21 V 8,0 Ah	203,00-

21 V POWER LINE

Stocker

Compatibile con le batterie della linea POWER 21 V.
Compatible con baterías de la línea POWER 21 V.
Kompatibel mit POWER 21 V Batterien.
Compatible with batteries of the POWER 21 V line.



- Ⓛ Ricambi
- Ⓔ Recambios
- Ⓓ Ersatzteile
- Ⓞ Spare parts

Art. 626

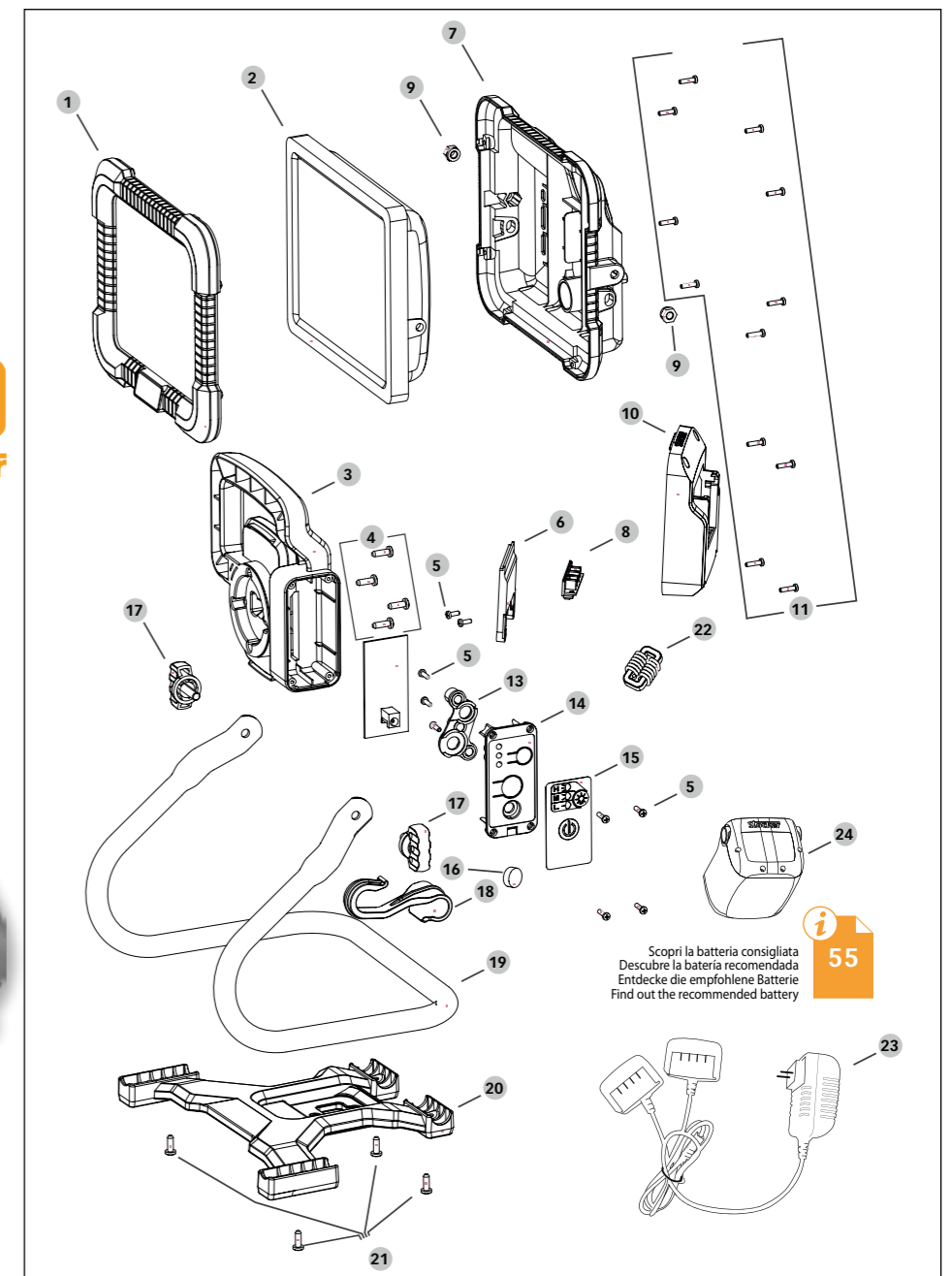

Scopri la batteria consigliata
Descubre la batería recomendada
Entdecke die empfohlene Batterie
Find out the recommended battery



#	Art.	IT	ES	DE	EN	€
1 + 11x8	626/1	Vetro frontale con viti	Vidrio frontal con tornillos	Frontscheibe mit Schrauben	Front glass panel with screws	2,20-
17x2	626/2	Manopole di fissaggio	Manopla de fijación	Befestigungsregler	Fastening knob	1,15-
12	626/3	Circuito stampato	Circuito impreso	Leiterplatte	Circuit	11,70-
5x7 + 13 + 14 + 15 + 16	626/4	Pannello di comando	Panel de control	Bedienfeld	Control panel	1,25-
18 + 19 + 20 + 21x4	626/5	Supporto in metallo con gancio in plastica	Soporte metálico con gancho de plástico	Ständer aus Metall mit Kunststoffhaken	Metal stand with plastic hook	11,15-
18	626/6	Gancio in plastica	Gancho de plástico	Kunststoffhaken	Plastic hook	0,60-
1 + 2 + 3 + 4x4 + 5x7 + 6 + 7 + 8 + 9x2 + 10 + 11x12 + 12 + 13 + 14 + 15 + 16	626/7	Assieme luce, senza stand	Conjunto luz, sin soporte	Kompletter Schweinwerferkopf ohne Ständer	Complete light head (assembled), without stand	50,60-
8	312/11	Contatti per batteria	Contactos batería	Batteriekontakte	Battery contacts	5,75-
5x2 + 6 + 10 + 11x4	625/9	Attacco batteria	Conexión batería	Batterieanschluss	Battery compartment	2,55-
23	312/8	Caricabatterie doppio 21 V	Cargador doble 21 V	Zweifach-Ladegerät 21 V	Double battery charger 21 V	27,05-
24	312/7	Batteria Power 21 V 2,6 Ah	Batería Power 21 V 2,6 Ah	Batterie Power 21 V 2,6 Ah	Battery Power 21 V 2,6 Ah	73,50-
24	325	Batteria Power 21 V 4,0 Ah	Batería Power 21 V 4,0 Ah	Batterie Power 21 V 4,0 Ah	Battery Power 21 V 4,0 Ah	118,00-
24	328	Batteria Power 21 V 8,0 Ah	Batería Power 21 V 8,0 Ah	Batterie Power 21 V 8,0 Ah	Battery Power 21 V 8,0 Ah	203,00-

21 V POWER LINE

Stocker

Compatible con le batterie della linea POWER 21 V.
Compatible con baterías de la línea POWER 21 V.
Kompatibel mit POWER 21 V Batterien.
Compatible with batteries of the POWER 21 V line.



- Ⓛ Ricambi
- Ⓔ Recambios
- Ⓓ Ersatzteile
- Ⓒ Spare parts

Art. 625

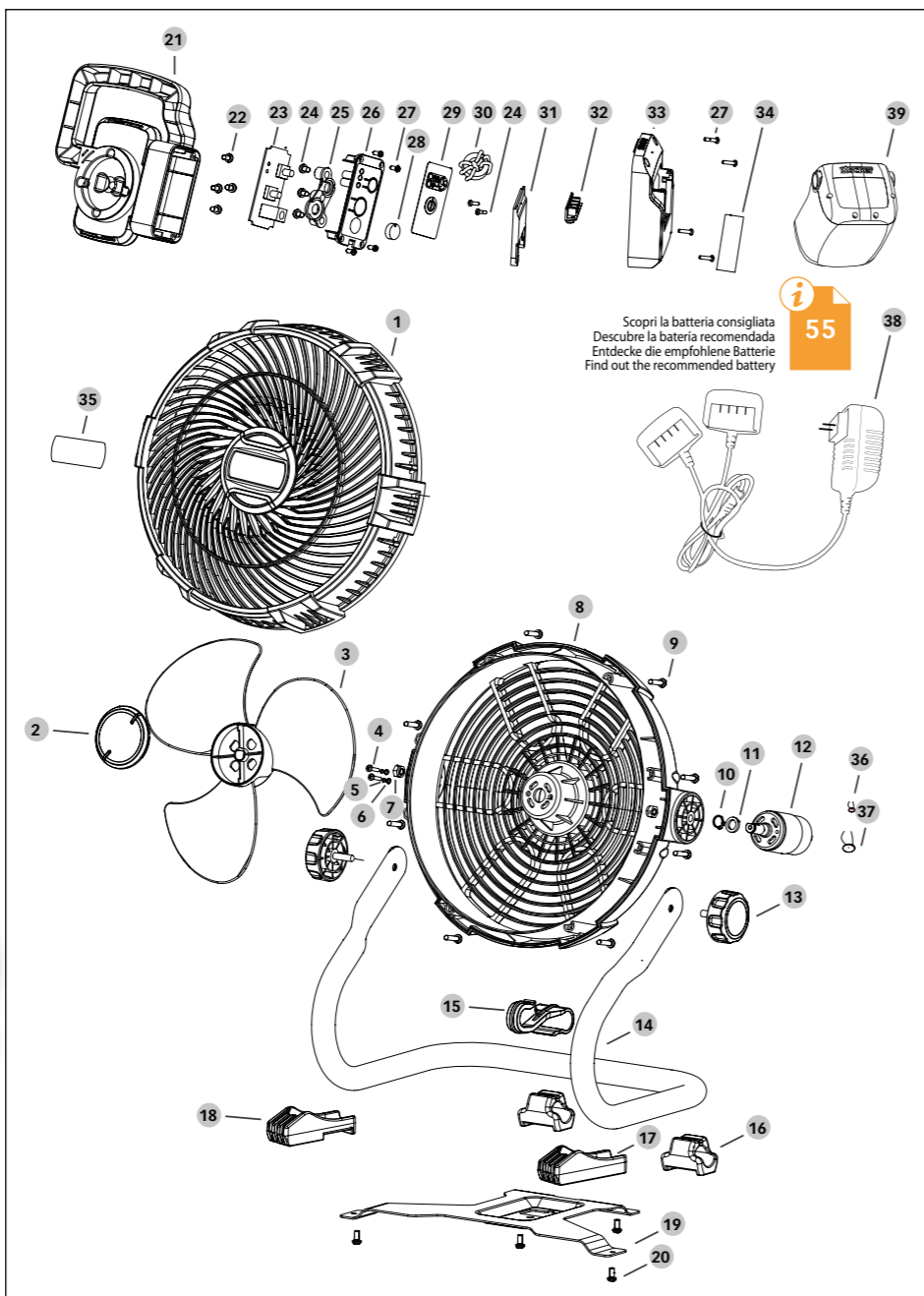

#	Art.	IT	ES	DE	EN	€
1 + 9x8 + 35	625/1	Copertura frontale	Cobertura del ventilador	Frontabdeckung	Front fan housing	10,95-
2 + 3 + 10 + 11	625/2	Ventola con coperchio	Ventilador con cubierta	Frontabdeckung und Ventilator	Fan with cover	2,70-
8	625/3	Copertura posteriore	Cobertura trasera	Hintere Abdeckung	Back cover	9,80-
13x2	625/4	Manopole di fissaggio	Manopla de fijación	Befestigungsregler	Fastening knob	2,10-
14 + 15 + 16x2 + 17 + 18 + 19 + 20x4	625/5	Supporto in metallo con gancio in plastica	Soporte metálico con gancho de plástico	Ständer aus Metall mit Kunststoffhaken	Metal stand with plastic hook	21,45-
15	625/6	Gancio in plastica	Gancho de plástico	Kunststoffhaken	Plastic hook	0,45-
23	625/7	Circuito stampato	Circuito impreso	Leiterplatte	Circuit	12,60-
24x3 + 25 + 26 + 27x4 + 28 + 29	625/8	Pannello di comando	Panel de control	Bedienfeld	Control panel	1,50-
24x2 + 27x4 + 31 + 33 + 34	625/9	Attacco batteria	Conexión batería	Batterieanschluss	Battery compartment	2,55-
1 + 2 + 3 + 4x2 + 5x2 + 6x2 + 7x2 + 8 + 9x8 + 10 + 11 + 12 + 21 + 22x4 + 23 + 24 x5 + 25 + 26 + 27x8 + 28 + 29 + 30 + 31 + 32 + 33 + 34 + 35 + 36 + 37	625/10	Assieme ventola, senza stand	Conjunto ventilador, sin soporte	Kompletter Ventilatorkopf ohne Ständer	Complete fan head (assembled), without stand	49,35-
37	625/11	Fusibile	Fusible	Sicherung	Fuse	0,25-
32	312/11	Contatti per batteria	Contactos batería	Batteriekontakte	Battery contacts	5,75-
38	312/8	Caricabatterie doppio 21 V	Cargador doble 21 V	Zweifach-Ladegerät 21 V	Double battery charger 21 V	27,05-
39	312/7	Batteria Power 21 V 2,6 Ah	Batería Power 21 V 2,6 Ah	Batterie Power 21 V 2,6 Ah	Battery Power 21 V 2,6 Ah	73,50-
39	325	Batteria Power 21 V 4,0 Ah	Batería Power 21 V 4,0 Ah	Batterie Power 21 V 4,0 Ah	Battery Power 21 V 4,0 Ah	118,00-
39	328	Batteria Power 21 V 8,0 Ah	Batería Power 21 V 8,0 Ah	Batterie Power 21 V 8,0 Ah	Battery Power 21 V 8,0 Ah	203,00-

21 V POWER LINE

Stocker

Compatible con le batterie della linea POWER 21 V.
Compatible con baterías de la línea POWER 21 V.
Kompatibel mit POWER 21 V Batterien.
Compatible with batteries of the POWER 21 V line.



- Ⓛ Ricambi
- Ⓔ Recambios
- Ⓓ Ersatzteile
- Ⓒ Spare parts

Art. 627

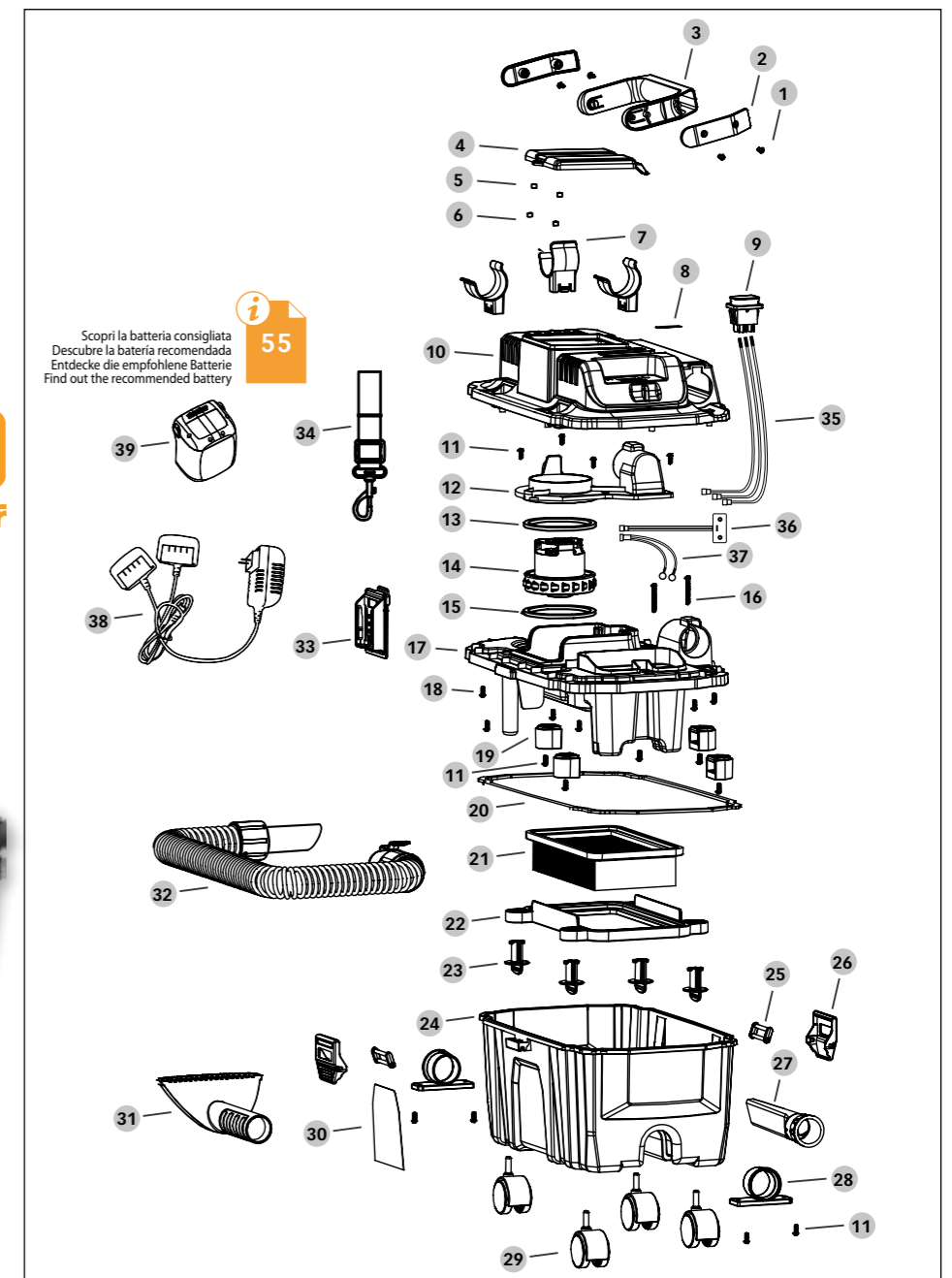

#	Art.	IT	ES	DE	EN	€
32	627/1	Tubo di aspirazione	Tubo de aspiración	Tubo di aspirazione	Vacuum hose	8,75-
27 + 31	627/2	Set teste di aspirazione	Juego de cabezales de aspiración	Set teste di aspirazione	Vacuum head set	1,45-
29x4 + 34	627/3	Cinghia a tracolla e 4 ruote	Correa para el hombro y 4 ruedas	Cinghia a tracolla e 4 ruote	Shoulder strap and 4 wheels	5,85-
11x4 + 24 + 25x2 + 26x2 + 28x2 + 30	627/4	Serbatoio	Tanque	Serbatoio	Tank	9,65-
25 + 26	627/5	Levetta di chiusura serbatoio	Palanca de cierre del tanque	Levetta di chiusura serbatoio	Tank closure lever	1,15-
22 + 23x4	627/6	Set fissaggio filtro HEPA	Juego de fijación del filtro HEPA	Set fissaggio filtro HEPA	HEPA filter fixing set	2,65-
33	627/7	Alloggiamento per batteria con contatti	Compartimento para batería con contactos	Alloggiamento per batteria con contatti	Battery compartment with contacts	1,45-
14 + 15	627/8	Motore con circuito stampato e cavi	Motor con circuito impreso y cables	Motore con circuito stampato e cavi	Motor with printed circuit board and cables	68,30-
9	627/9	Interruttore	Interruptor	Interruttore	Power button	4,65-
4	627/10	Coperchio vano batteria	Tapa compartimento batería	Coperchio vano batteria	Battery compartment cover	0,95-
7x3	627/11	Clip ferma tubo	Abrazadera de tubo	Clip ferma tubo	Hose holder clip	0,60-
35 + 36 + 37	627/12	Scheda LED livello batteria e set cavi elettrici	Tablero LED con nivel de batería y juego de cables eléctricos	Scheda LED livello batteria e set cavi elettrici	Battery level LED board and cable set	9,65-
21	628	Filtro HEPA	Filtro HEPA	HEPA-Filter	HEPA filter	11,00-
38	312/8	Caricabatterie doppio 21 V	Cargador doble 21 V	Zweifach-Ladegerät 21 V	Double battery charger 21 V	27,05-
39	312/7	Batteria Power 21 V 2,6 Ah	Batería Power 21 V 2,6 Ah	Batterie Power 21 V 2,6 Ah	Battery Power 21 V 2,6 Ah	73,50-
39	325	Batteria Power 21 V 4,0 Ah	Batería Power 21 V 4,0 Ah	Batterie Power 21 V 4,0 Ah	Battery Power 21 V 4,0 Ah	118,00-



- ① Ricambi
- Ⓔ Recambios
- Ⓓ Ersatzteile
- Ⓞ Spare parts

Art. 315

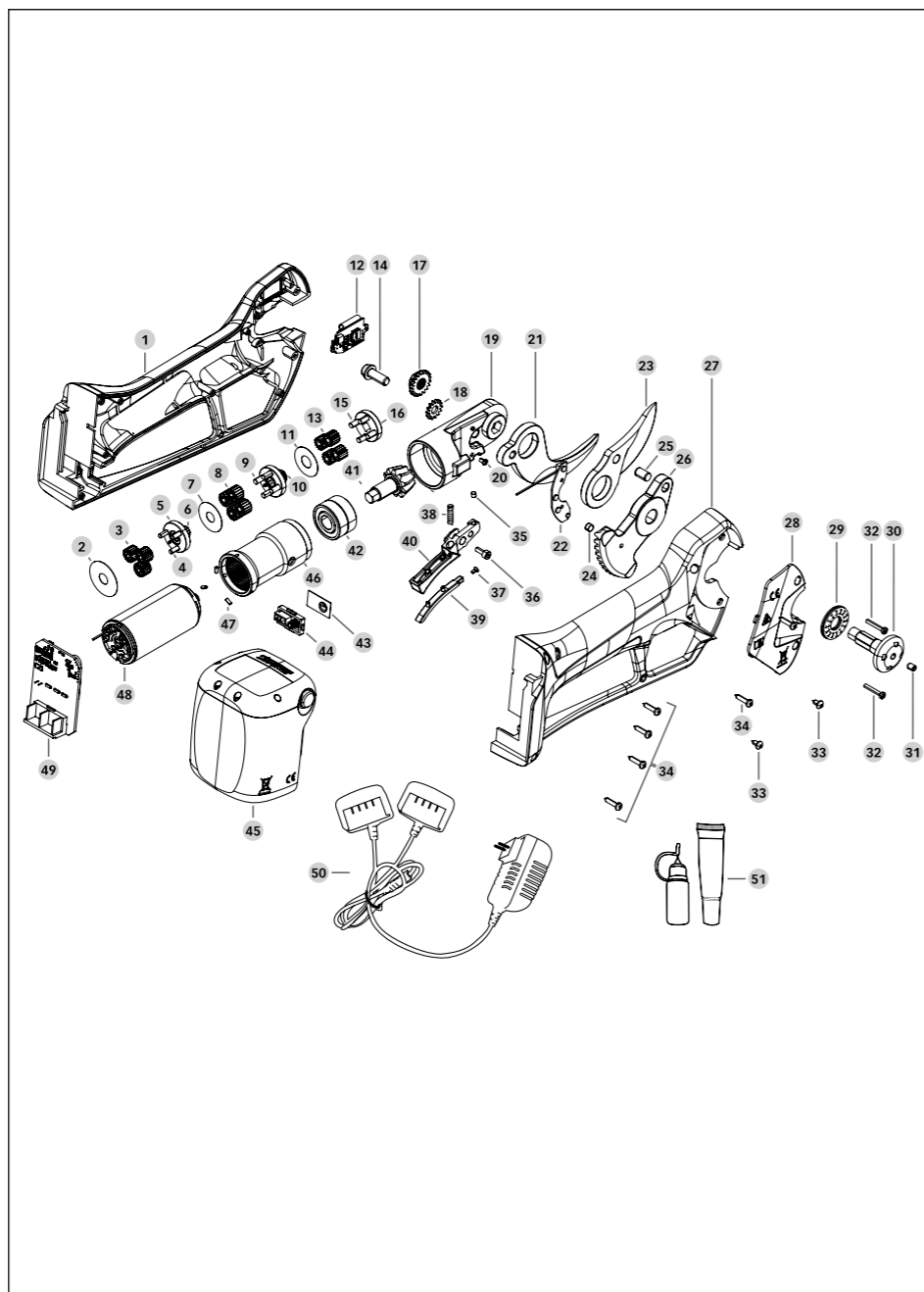

#	Art.	IT	ES	DE	EN	€
14+17+18+29+30+31	315/1	Kit di fissaggio lama	Kit de fijación hoja	Fixier-Kit für Klinge	Fixing blade kit	13,90-
23+24+25+26	315/2	Lama per forbice elettrica	Hoja para tijera eléctrica	Klinge für elektrische Baumschere	Blade for electric shears	31,15-
21	315/3	Controlama per forbice elettrica	Contra hoja para tijera eléctrica	Gegenklinge für elektrische Baumschere	Anvil for electric shears	19,10-
1+27+34x5+33x2	315/4	Set copertura per forbice elettrica	Set cobertura para tijera eléctrica	Abdeckungsset für elektrische Baumschere	Cover for electric shears set	21,00-
28+32x2	315/5	Copertura di testa per forbice elettrica	Cobertura de cabeza para tijera eléctrica	Kopfabdeckung für elektrische Baumschere	Head cover for electric shears	5,25-
43+44	315/6	Interruttore	Interruptor	Ein-/Ausschalter	Power button	4,75-
45	315/7	Batteria Li-Ion	Batería Li-Ion	Batterie Li-Ion	Li-Ion Battery	96,30-
50	315/8	Caricabatterie doppio	Cargador doble	Zweifach-Ladegerät	Double battery charger	31,50-
2+3+4+5+6+7+8+9+10+11+13+15+16+19+41+42+44+47+48	315/9	Motoriduttore con attacco per lama	Motorreductor con conexión para hoja	Reduziergetriebe mit Motor	Geared motor with connection for blade	157,50-
49	315/10	Circuito stampato con contatti batteria	Circuito impreso con contactos batería	Leiterplatte mit Batteriekontakte	Printed circuit board with battery contacts	66,50-
20+22+35+36+37+38+39+40	315/11	Grilletto con sensore	Gatillo con sensor	Auslöser mit Sensor	Trigger with sensor	20,65-
12	315/12	Display LED	Pantalla LED	LED Display	Display LED	21,00-
20+32x2+33x2+34x5+36+37	315/13	Kit viti completo	Kit tornillos completo	Kit Schrauben komplett	Complete screws set	5,60-
-	315/14	Valigetta per forbice elettrica	Maletín para tijera eléctrica	Koffer für elektrische Baumschere	Suitcase for electric shears	31,50-
51	310/18	Set olio e grasso	Set de aceite y grasa	Set Schmierfett und Schmieröl	Oil and grease set	5,10-



- ① Ricambi
- Ⓔ Recambios
- Ⓓ Ersatzteile
- Ⓞ Spare parts

Art. 311

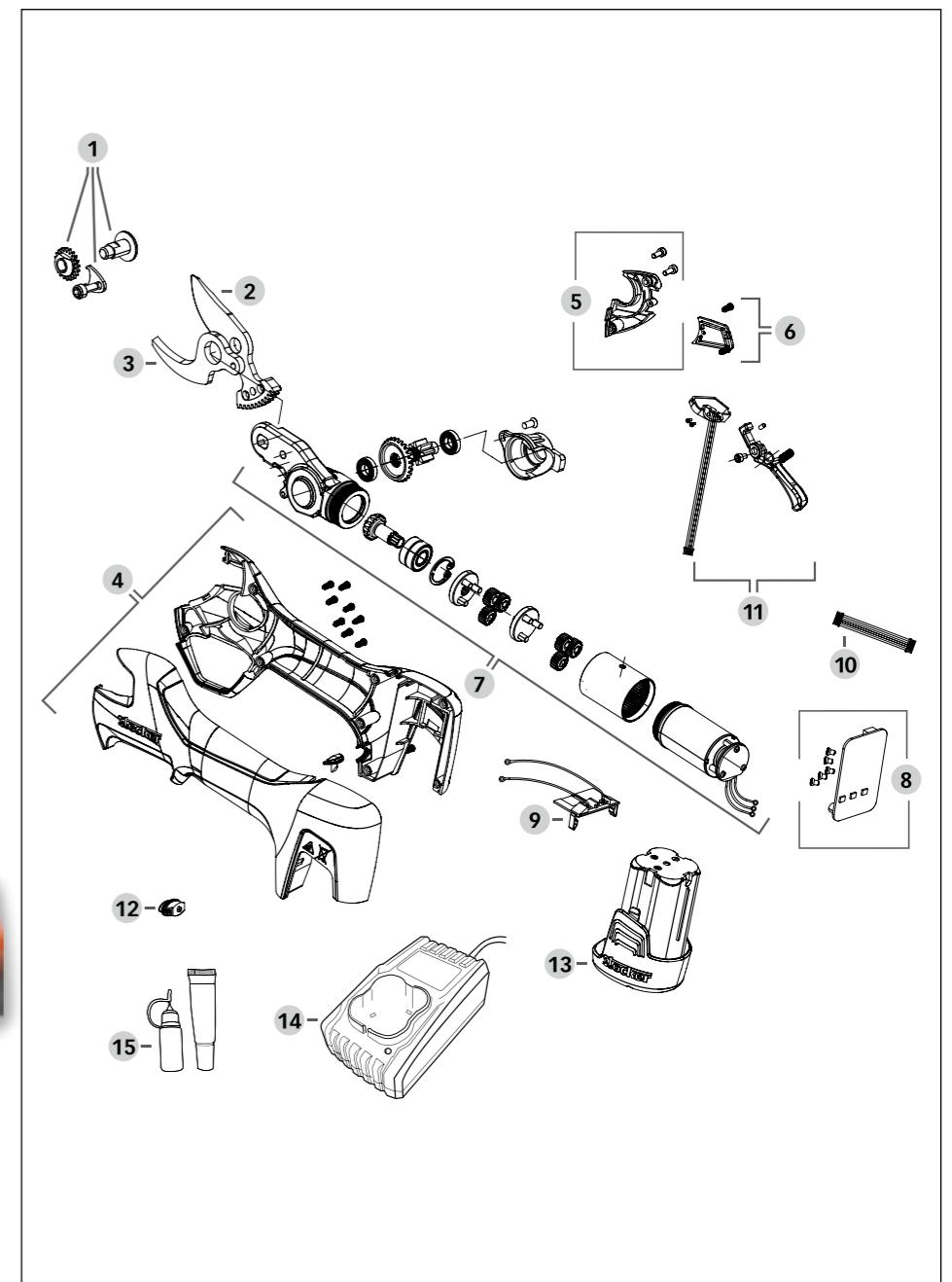

#	Art.	IT	ES	DE	EN	€
1	311/1	Kit di fissaggio lama	Kit de fijación hoja	Fixier-Kit für Klinge	Fixing blade kit	9,35-
2	311/2	Lama per forbice elettrica	Hoja para tijera eléctrica	Klinge für elektrische Baumschere	Blade for electric shears	21,65-
3	311/3	Controlama per forbice elettrica	Contra hoja para tijera eléctrica	Gegenklinge für elektrische Baumschere	Anvil for electric shears	15,30-
4	311/4	Set copertura per forbice elettrica	Set cobertura para tijera eléctrica	Abdeckungsset für elektrische Baumschere	Cover for electric shears set	12,45-
5/6	311/5	Copertura di testa per forbice elettrica	Cobertura de cabeza para tijera eléctrica	Kopfabdeckung für elektrische Baumschere	Head cover for electric shears	5,40-
7	311/6	Motoriduttore con attacco per lama	Motorreductor con conexión para hoja	Reduziergetriebe mit Motor	Geared motor with connection for blade	169,50-
8	311/7	Circuito stampato	Circuito impreso	Leiterplatte	Printed circuit board	90,10-
9	311/8	Contatti per batteria	Contactos batería	Batteriekontakte	Battery contacts	5,75-
10	311/9	Cavo 6P	Cable 6P	Kabel 6P	6P cable	1,20-
11	311/10	Grilletto con sensore	Gatillo con sensor	Auslöser mit Sensor	Trigger with sensor	12,25-
12	310/6	Interruttore	Interruptor	Ein-/Ausschalter	Power button	1,80-
13	310/7	Batteria Li-Ion	Batería Li-Ion	Batterie Li-Ion	Li-Ion battery	64,90-
14	310/8	Caricabatteria	Cargador	Ladegerät	Battery charger	23,45-
	311/11	Kit viti completo	Kit tornillos completo	Kit Schrauben komplett	Complete screws kit	1,80-
	311/12	Valigetta per forbice elettrica	Maletín para tijera eléctrica	Koffer für elektrische Baumschere	Suitcase for electric shears	14,40-
2/3	311/13	Lama e controlama per forbice elettrica	Hoja y contra hoja para tijera eléctrica	Klinge und Unterlage für elektrische Baumschere	Blade and anvil for electric shears	33,35-
15	310/18	Set olio e grasso	Set de aceite y grasa	Set Schmierfett und Schmieröl	Oil and grease set	5,10-



- Ⓛ Ricambi
- ⓔ Recambios
- ⓓ Ersatzteile
- Ⓞ Spare parts

Art. 310, 314

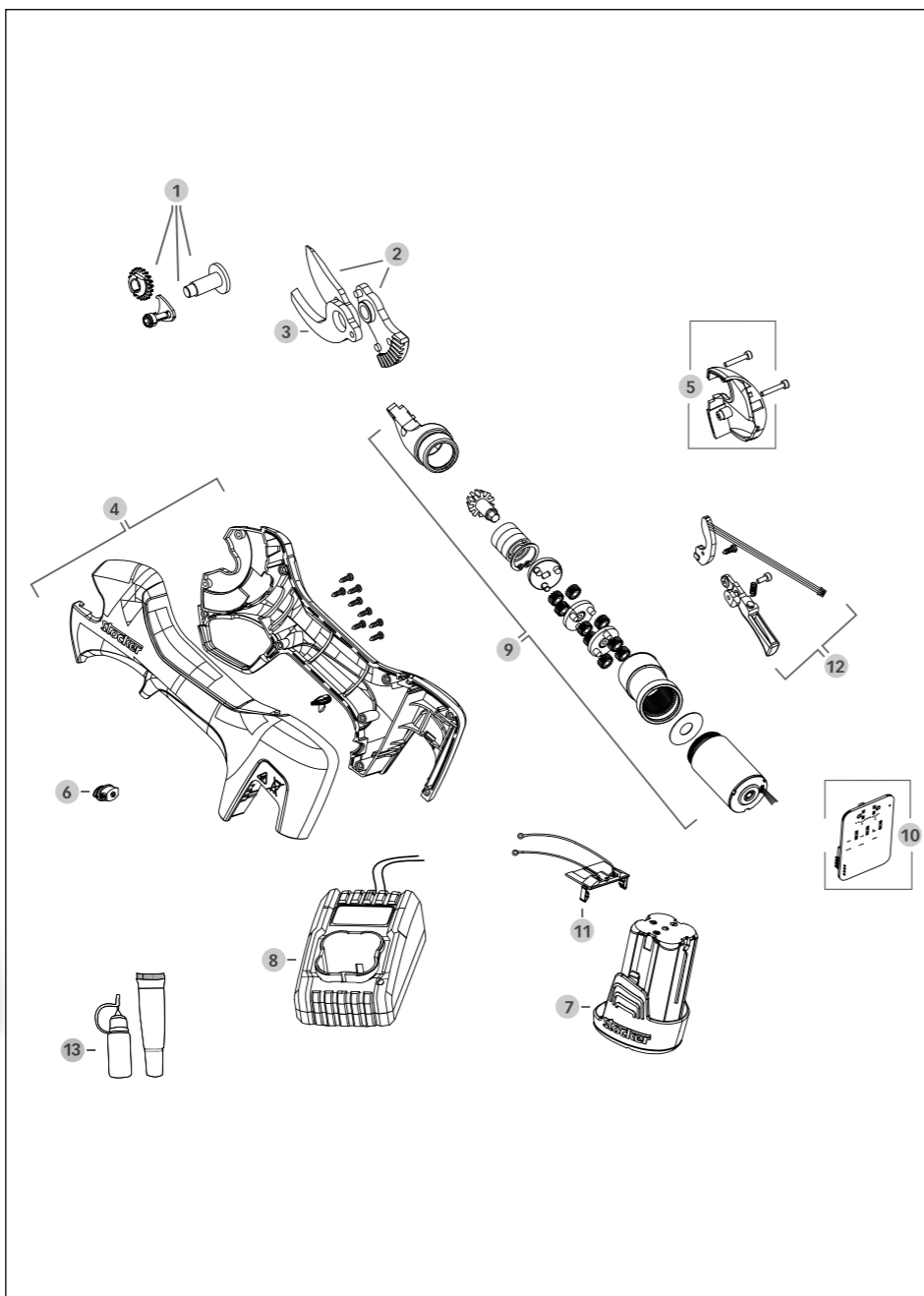

#	Art.	IT	ES	DE	EN	€
1	310/1	Kit di fissaggio lama	Kit de fijación hoja	Fixier-Kit für Klinge	Fixing blade kit	8,80-
2	310/2	Lama per forbice elettrica	Hoja para tijera eléctrica	Klinge für elektrische Baumschere	Blade for electric shears	19,45-
3	310/3	Controlama per forbice elettrica	Contra hoja para tijera eléctrica	Gegenklinge für elektrische Baumschere	Anvil for electric shears	14,05-
4	310/4	Set copertura per forbice elettrica	Set cobertura para tijera eléctrica	Abdeckungsset für elektrische Baumschere	Cover for electric shears set	11,75-
5	310/5	Copertura di testa per forbice elettrica	Cobertura de cabeza para tijera eléctrica	Kopfabdeckung für elektrische Baumschere	Head cover for electric shears	3,60-
6	310/6	Interruttore	Interruptor	Ein-/Ausschalter	Power button	1,80-
7	310/7	Batteria Li-Ion	Batería Li-Ion	Batterie Li-Ion	Li-Ion battery	64,90-
8	310/8	Caricabatteria	Cargador	Ladegerät	Battery charger	23,45-
9	310/9	Motoriduttore con attacco per lama	Motorreductor con conexión para hoja	Reduziergetriebe mit Motor	Geared motor with connection for blade	126,00-
10	310/10	Circuito stampato	Circuito impreso	Leiterplatte	Printed circuit board	86,50-
11	310/11	Contatti per batteria	Contactos batería	Batteriekontakte	Battery contacts	4,90-
12	310/13	Grilletto con sensore	Gatillo con sensor	Auslöser mit Sensor	Trigger with sensor	12,05-
	310/14	Kit viti completo	Kit tornillos completo	Kit Schrauben komplett	Complete screws kit	1,75-
	310/15	Valigetta per forbice elettrica	Maletín para tijera eléctrica	Koffer für elektrische Baumschere	Suitcase for electric shears	14,40-
13	310/18	Set olio e grasso	Set de aceite y grasa	Set Schmierfett und Schmieröl	Oil and grease set	5,10-

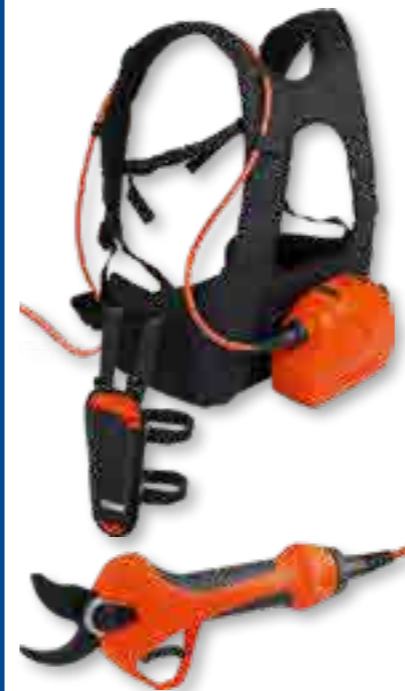

- Ⓛ Ricambi
- ⓔ Recambios
- ⓓ Ersatzteile
- Ⓞ Spare parts

Art. 313

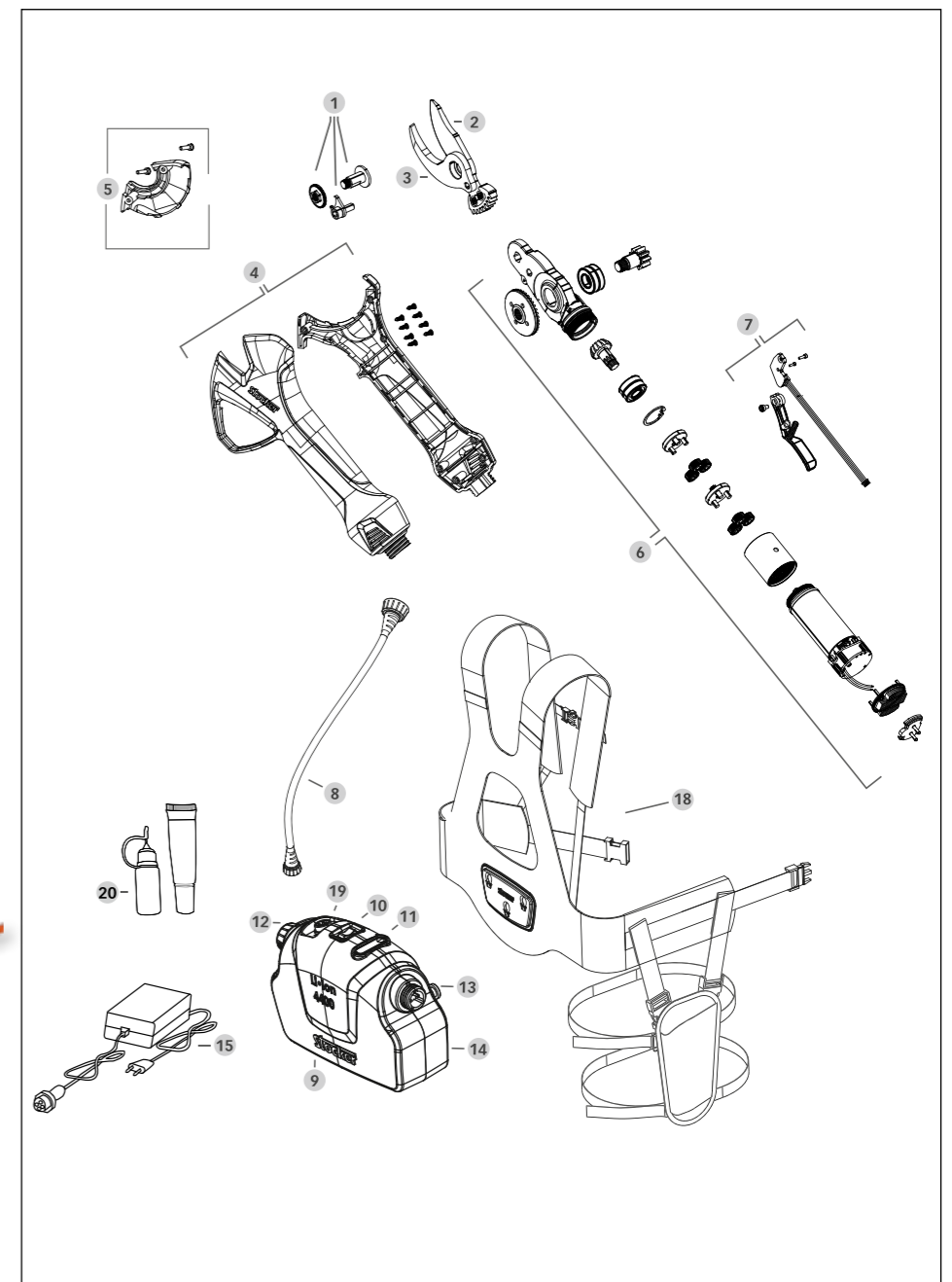

#	Art.	IT	ES	DE	EN	€
1	313/1	Kit di fissaggio lama	Kit de fijación hoja	Fixier-Kit für Klinge	Fixing blade kit	9,25-
2	313/2	Lama per forbice elettrica	Hoja para tijera eléctrica	Klinge für elektrische Baumschere	Blade for electric shears	30,50-
3	313/3	Controlama per forbice elettrica	Contra hoja para tijera eléctrica	Gegenklinge für elektrische Baumschere	Anvil for electric shears	22,75-
4	313/4	Set copertura per forbice elettrica	Set cobertura para tijera eléctrica	Abdeckungsset für elektrische Baumschere	Cover for electric shears set	12,40-
5	313/5	Copertura di testa per forbice elettrica	Cobertura de cabeza para tijera eléctrica	Kopfabdeckung für elektrische Baumschere	Head cover for electric shears	5,40-
6	313/6	Motoriduttore con attacco per lama	Motorreductor con conexión para hoja	Reduziergetriebe mit Motor	Geared motor with connection for blade	261,00-
7	313/7	Grilletto con sensore	Gatillo con sensor	Auslöser mit Sensor	Trigger with sensor	15,05-
8	313/8	Cavo di alimentazione	Cable de alimentación	Kabel	Cable	35,00-
9	313/9	Batteria Li-Ion	Batería Li-Ion	Batterie Li-Ion	Li-Ion battery	350,00-
10	313/10	Interruttore	Interruptor	Ein-/Ausschalter	Power button	1,20-
11	313/11	Indicatore di carica	Indicador de carga	Batterieanzeige	Battery status indicator	4,05-
12	313/12	Tappo per batteria	Tapón para batería	Stöpsel für Batterie	Cap for battery	1,30-
13	313/13	Pin di fissaggio per batteria	Pin de fijación para batería	Fixier-Stift für Batterie	Fixing pin for battery	4,20-
14	313/14	Coperchio batteria	Tapa batería	Batterieabdeckung	Battery cover	28,00-
15	313/15	Caricabatteria	Cargador	Ladegerät	Battery charger	48,55-
	313/16	Kit viti completo	Kit tornillos completo	Kit Schrauben komplett	Complete screws set	1,80-
	313/17	Valigetta per forbice elettrica	Maletín para tijera eléctrica	Koffer für elektrische Baumschere	Suitcase for electric shears	28,00-
18	313/18	Bastino e fodero per forbice elettrica	Portador y funda para tijera eléctrica	Schultergurt und Tasche für elektrische Baumschere	Shoulder harness and sheath for electric shears	59,50-
19	313/19	Presa di carica	Puerto de carga	Ladebuchse	Charging port	3,30-
20	310/18	Set olio e grasso	Set de aceite y grasa	Set Schmierfett und Schmieröl	Oil and grease set	5,10-



① Ricambi
 ② Recambios
 ③ Ersatzteile
 ④ Spare parts
Art. 610, 611

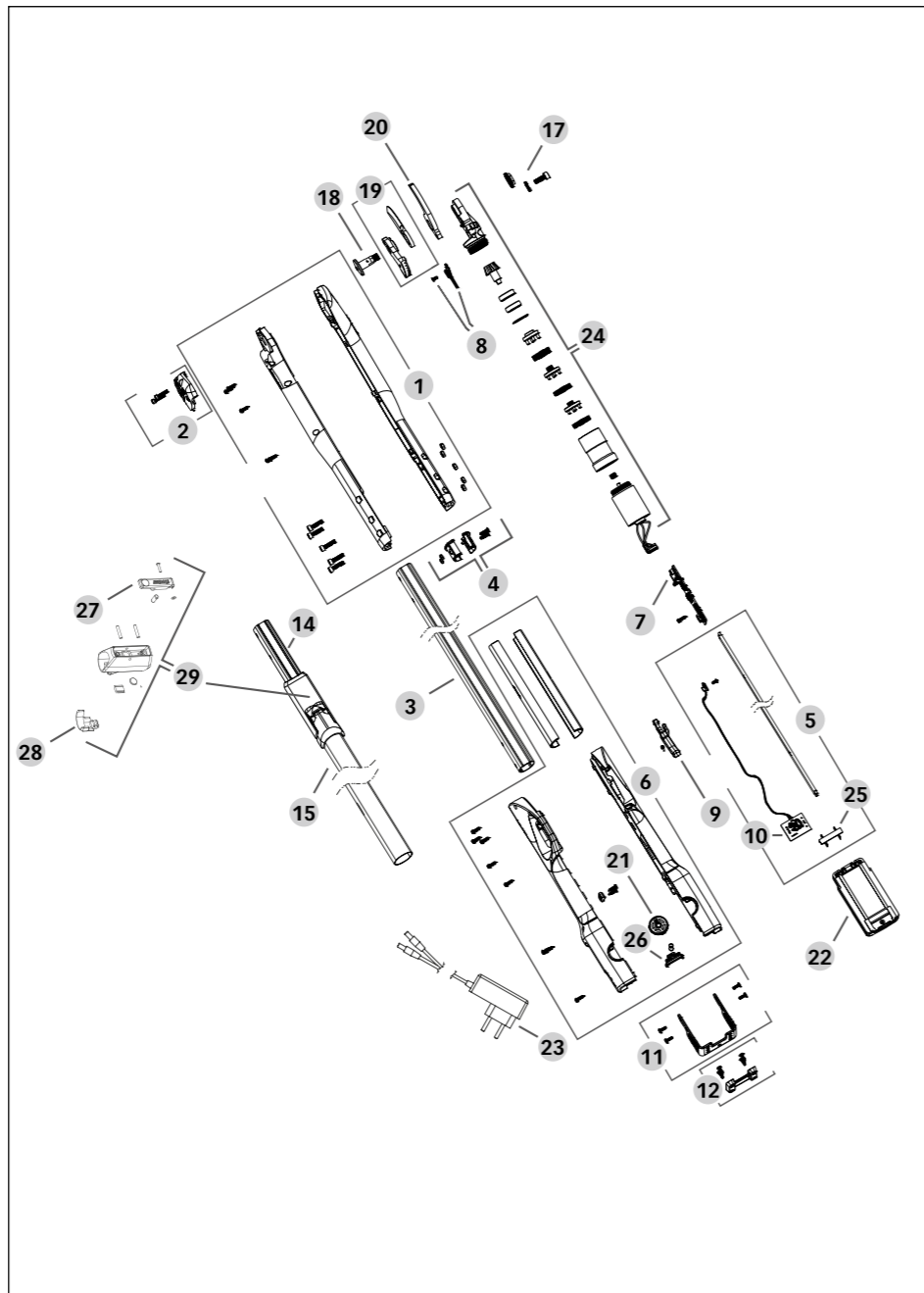

#	Art.	IT	ES	DE	EN	€
1	610/1	Set copertura superiore per forbice elettrica su asta	Set de tapa frontal	Vorderes Abdeckungsset	Front cover	18,05-
2	610/2	Copertura di testa per forbice elettrica su asta	Cobertura de cabeza	Kopfabdeckung	Head cover	2,70-
3	610/3	Tubo con rivestimento antiscivolo (Art. 610)	Tubo con revestimiento antideslizante (Art. 610)	Rohr mit Antirutschbelag (Art. 610)	Aluminum tube with non-slip grip (Item 610)	24,10-
4	610/4	Fermacavo interno	Abrazadera interna	Kabelhalter	Internal cable holder	2,70-
5	610/5	Cavo di alimentazione interno con connettori batteria e sensore grilletto inferiore (Art. 610)	Cable de alimentación con conectores de batería y sensor gatillo inferior (Art. 610)	Kabel mit Anschlüssen und Sensor für unteren Auslöser (Art. 610)	Power cable with battery connectors and bottom trigger sensor (Item 610)	53,00-
5	611/3	Cavo di alimentazione interno con connettori batteria e sensore grilletto inferiore (Art. 611)	Cable de alimentación con conectores de batería y sensor gatillo inferior (Art. 611)	Kabel mit Anschlüssen und Sensor für unteren Auslöser (Art. 611)	Power cable with battery connectors and bottom trigger sensor (Item 611)	60,90-
6	610/6	Set copertura per impugnatura	Set cobertura para empuñadura	Abdeckungsset für Griff	Cover for handle set	25,60-
7	610/8	Circuito stampato	Circuito impreso	Leiterplatte	Printed circuit board	30,75-
8	610/9	Sensore grilletto superiore	Sensor gatillo superior	Sensor für oberen Auslöser	Upper trigger sensor	9,60-
11	610/11	Protezione per batteria in metallo	Protección batería	Batterieschutz	Battery protection	12,00-
12	610/12	Gommino d'appoggio	Gomitas de apoyo	Gummi-Stoßschutz	Rubber feet	5,00-
14	611/1	Tubo interno (Art. 611)	Tubo interno (Art. 611)	Innenrohr (Art. 611)	Internal tube (Item 611)	19,70-
15	611/2	Tubo esterno con rivestimento antiscivolo (Art. 611)	Tubo externo con revestimiento antideslizante (Art. 611)	Außenrohr mit Antirutschbelag (Art. 611)	External tube with non-slip grip (Item 611)	29,50-
19	309/2	Lama per forbice elettrica	Hoja para tijera eléctrica	Klinge für elektrische Baumschere	Blade for electric shears	17,10-
20	309/3	Controlama per forbice elettrica	Contra hoja para tijera eléctrica	Gegenklinge für elektrische Baumschere	Anvil for electric shears	10,15-
21	309/6	Interruttore	Interruptor	Ein-/Aus-Schalter	Power button	1,00-
22	309/7	Batteria Li-Ion	Batería Li-Ion	Batterie Li-Ion	Li-Ion Battery	41,65-
23	309/8	Caricabatterie doppio	Cargador doble	Zweifach-Ladegerät	Double battery charger	18,00-
24	309/9	Motoriduttore con attacco per lama	Motorreductor con conexión para hoja	Reduziergetriebe mit Motor	Geared motor with connection for blade	67,80-
25	309/11	Contatti per batteria	Contactos batería	Batteriekontakte	Battery contacts	1,75-
26	309/13	Blocco batteria con molla	Bloqueo de batería con muelle	Batterierschluss mit Feder	Locking battery system with spring	2,40-
27	559/2	Pulsante di blocco	Botón de bloqueo	Blockierknopf	Locking button	3,00-
28	565/2	Leva di bloccaggio Profi	Palanca de bloqueo Profi	Blockierknopf Profi	Locking clip Profi	3,00-
29	565/3	Blocco Profi	Bloqueo Profi	Blockiersystem Profi	Profi stopper	9,50-
17, 18	309/1	Kit di fissaggio lama	Kit de fijación hoja	Fixier-Kit für Klinge	Fixing blade kit	5,00-
9, 10	610/10	Grilletto con sensore e circuito stampato	Gatillo con sensor y circuito impreso	Auslöser mit Sensor und Leiterplatte	Trigger with sensor and printed circuit board	23,25-
	610/13	Kit viti completo	Kit tornillos completo	Kit Schrauben komplett	Complete screw set	8,75-



① Ricambi
 ② Recambios
 ③ Ersatzteile
 ④ Spare parts
Art. 309

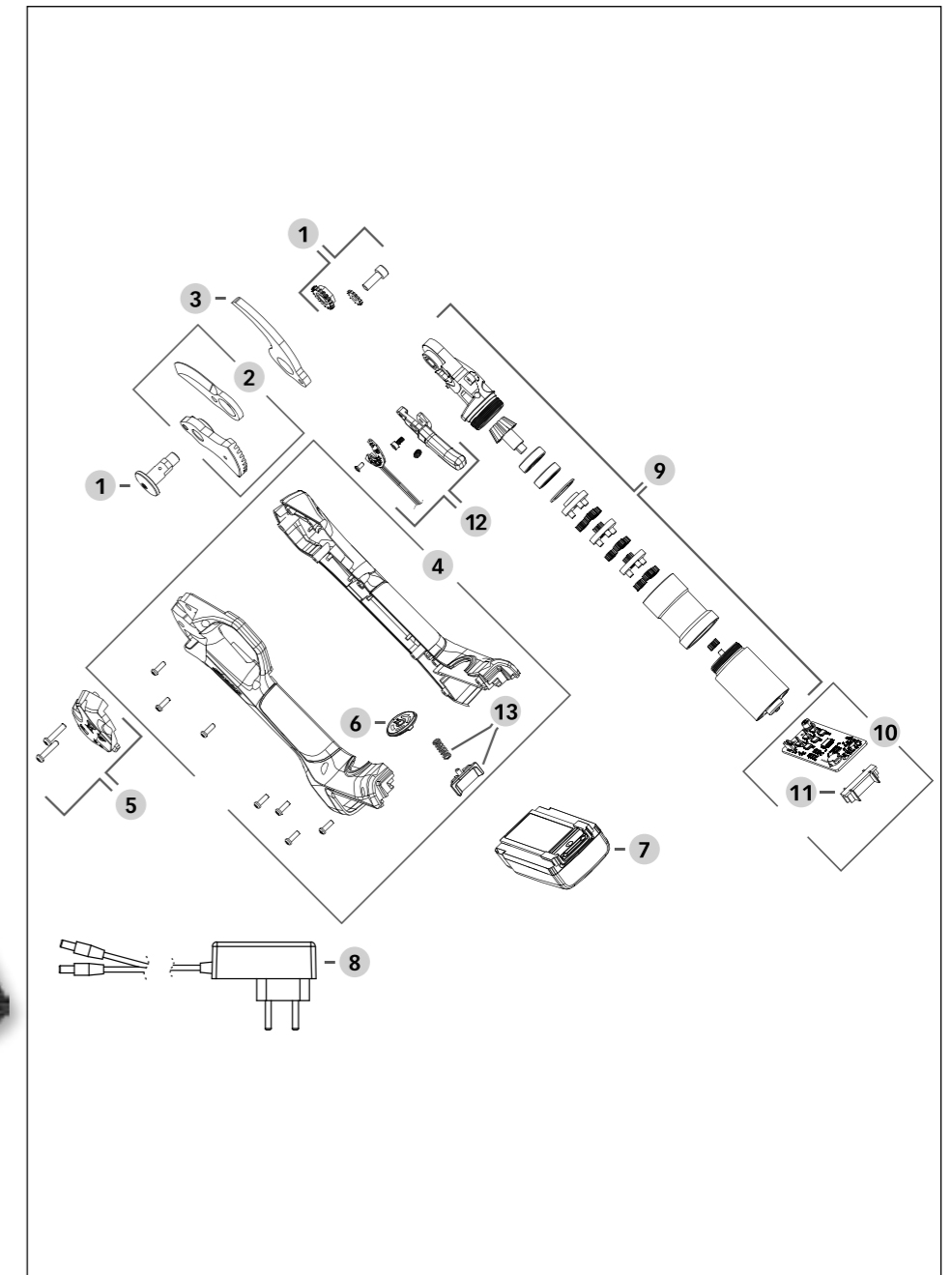

#	Art.	IT	ES	DE	EN	€
1	309/1	Kit di fissaggio lama	Kit de fijación hoja	Fixier-Kit für Klinge	Fixing blade kit	5,00-
2	309/2	Lama per forbice elettrica	Hoja para tijera eléctrica	Klinge für elektrische Baumschere	Blade for electric shears	17,10-
3	309/3	Controlama per forbice elettrica	Contra hoja para tijera eléctrica	Gegenklinge für elektrische Baumschere	Anvil for electric shears	10,15-
4	309/4	Set copertura per forbice elettrica	Set cobertura para tijera eléctrica	Abdeckungsset für elektrische Baumschere	Cover for electric shears set	9,45-
5	309/5	Copertura di testa per forbice elettrica	Cobertura de cabeza para tijera eléctrica	Kopfabdeckung für elektrische Baumschere	Head cover for electric shears	1,25-
6	309/6	Interruttore	Interruptor	Ein-/Aus-Schalter	Power button	1,00-
7	309/7	Batteria Li-Ion	Batería Li-Ion	Batterie Li-Ion	Li-Ion Battery	41,65-
8	309/8	Caricabatterie doppio	Cargador doble	Zweifach-Ladegerät	Double battery charger	18,00-
9	309/9	Motoriduttore con attacco per lama	Motorreductor con conexión para hoja	Reduziergetriebe mit Motor	Geared motor with connection for blade	67,80-
10	309/10	Circuito stampato con contatti batteria	Circuito impreso con contactos batería	Leiterplatte mit Batteriekontakte	Printed circuit board with battery contacts	40,75-
11	309/11	Contatti per batteria	Contactos batería	Batteriekontakte	Battery contacts	1,75-
12	309/12	Grilletto con sensore	Gatillo con sensor	Auslöser mit Sensor	Trigger with sensor	13,50-
13	309/13	Blocco batteria con molla	Bloqueo de batería con muelle	Batterierschluss mit Feder	Locking battery system with spring	2,40-
	309/14	Kit viti completo	Kit tornillos completo	Kit Schrauben komplett	Complete screws kit	3,35-



- Ⓘ Ricambi
- Ⓔ Recambios
- Ⓓ Ersatzteile
- Ⓒ Spare parts

Art. 321

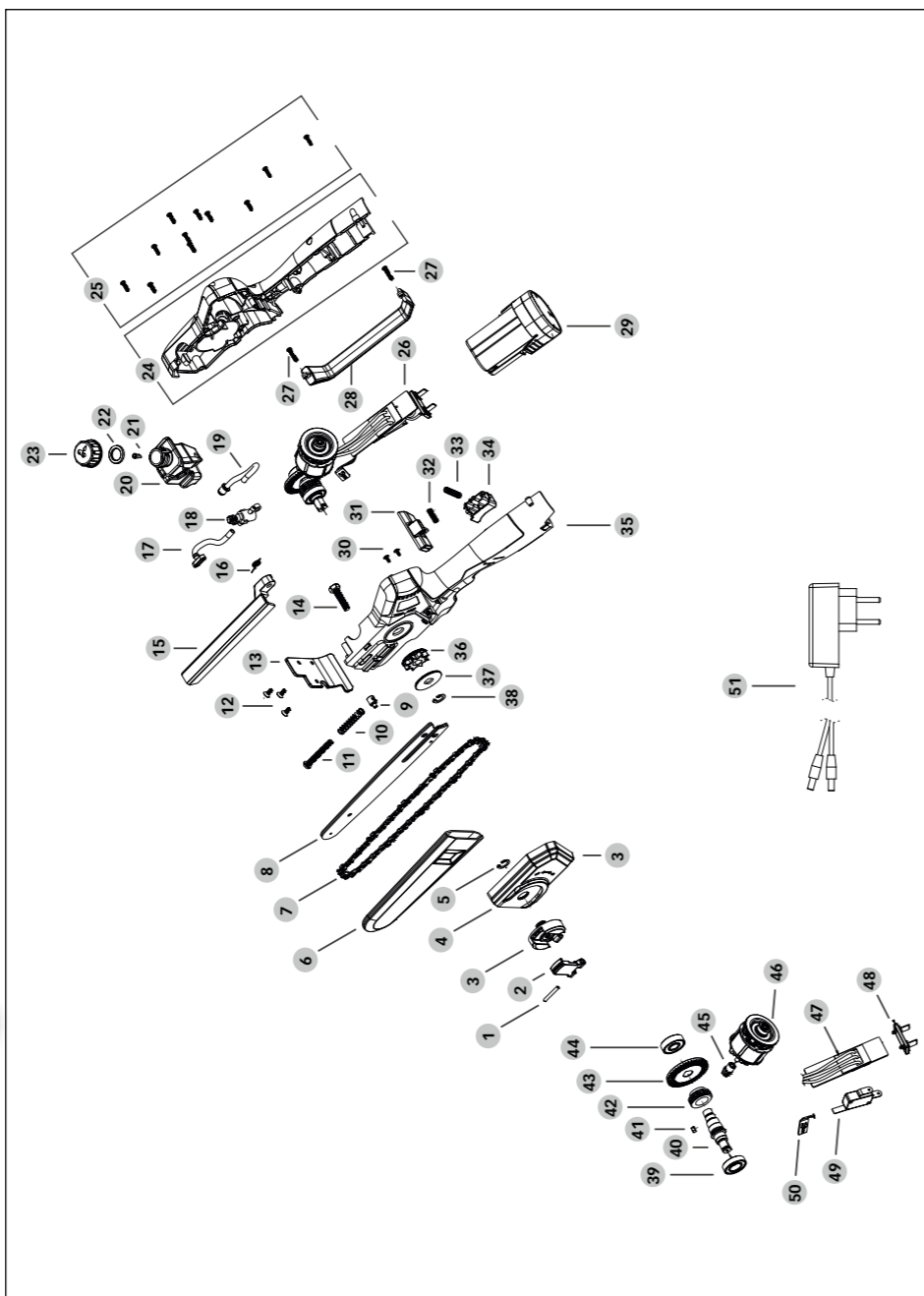

#	Art.	IT	ES	DE	EN	€
9 + 10 + 11 + 24 + 25x11 + 30x2 + 35	321/1	Set copertura per motosega	Juego de fundas para motosierras	Abdeckungset für elektrische Motorsäge	Cover set for chainsaws	15,15-
27x2 + 28	321/2	Protezione mano	Protección para manos	Handschutz	Hand protection	2,50-
15 + 16	321/3	Copertura protettiva 18,5 cm / 6"	Capa protectora flexible 18,5 cm / 6"	Flexible Schutzhülse 18,5 cm / 6"	Protective cover 18,5 cm / 6"	2,50-
39 + 40 + 41 + 42 + 43 + 44 + 45 + 46	321/4	Motoriduttore	Motorreductor	Reduziergetriebe mit Motor	Geared motor	60,00-
47 + 48 + 50	321/5	Circuito stampato con interruttore ON/OFF e contatti batteria	Circuito impreso con ON/OFF interruptor y contactos batería	Leiterplatte mit ON/OFF-Schalter und Batteriekontakte	Printed circuit board with ON/OFF button and battery contacts	27,65-
20 + 21 + 22 + 23	321/6	Tanica olio lubrificante catena con tappo	Contenedor para aceite lubricante de cadena con tapón	Tank für Kettenöl mit Deckel	Chain lubricating oil tank with cap	8,50-
21 + 22 + 23	321/7	Tappo tanica olio lubrificante catena	Tapón tanque de aceite lubricante de cadena	Deckel für Kettenöltank	Chain lubricating oil tank cap	2,15-
17 + 18 + 19	321/8	Pompa olio lubrificante catena con tubi di mandata	Bomba de aceite lubricante de cadena con tubos de entrada	Kettenölpumpe mit Verbindungsschlauch	Chain lubricating oil pump with delivery pipes	12,75-
9 + 10 + 11 + 12x3 + 14 + 16 + 25x11 + 27x2 + 30x2 + 32 + 33	321/9	Kit viti completo e molle	Kit tornillos completo y muelles	Kit Schrauben komplett und Federn	Complete screws kit and springs	4,65-
7	317/1	Catena 37 denti 1/4" 1,1 mm	Cadena 37 dientes 1/4" 1,1 mm	Kette 37 Zähne 1/4" 1,1 mm	Chain 37 teeth 1/4" 1,1 mm	19,15-
8	317/2	Spranga 18,5 cm / 6"	Barra guía 18,5 cm / 6"	Schwert 18,5 cm / 6"	Guide bar 18,5 cm / 6"	13,05-
6	317/4	Fodero catena 18,5 cm / 6"	Funda cadena 18,5 cm / 6"	Transportschutz für Schwert 18,5 cm / 6"	Chain sheath 13 cm / 6"	2,50-
1 + 2 + 3 + 4 + 5	320/5	Coperchio roccetto catena	Tapa del piñón de cadena	Kettenradabdeckung	Chain sprocket cover	3,45-
29	320/7	Batteria Li-Ion	Batería Li-Ion	Batterie Li-Ion	Li-Ion Battery	40,00-
51	320/8	Caricabatterie doppio	Cargador doble	Zweifach-Ladegerät	Double battery charger	12,00-
31 + 32 + 33 + 34	320/10	Grilletto e tasto di sicurezza	Gatillo y botón de seguridad	Auslöser und Sperrschalter	Trigger with safety button	1,65-
49	320/11	Interruttore	Interruptor	Ein-/Aus-Schalter	Power button	1,05-
12x3 + 13	320/15	Protezione frontale antiurto	Protección contra impactos frontales	Frontaufprallschutz	Front impact protection	3,25-
36 + 37 + 39	320/16	Pignone con rondella	Piñon con arandela	Ritzel mit Unterlegscheibe	Sprocket with washer	4,85-



- Ⓘ Ricambi
- Ⓔ Recambios
- Ⓓ Ersatzteile
- Ⓒ Spare parts

Art. 320

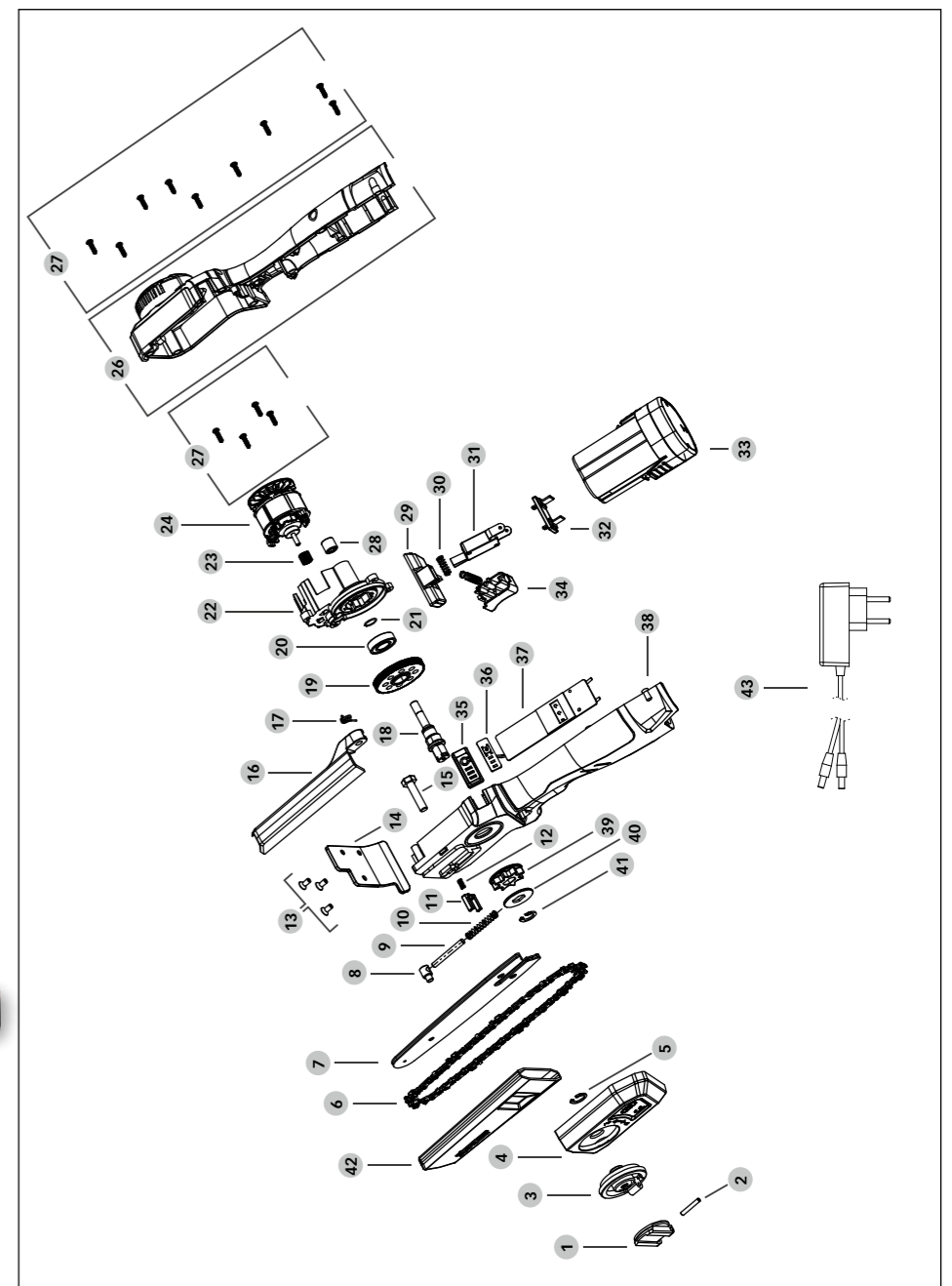

#	Art.	IT	ES	DE	EN	€
6	320/1	Catena 32 denti 1/4" 1,1 mm	Cadena 32 dientes 1/4" 1,1 mm	Kette 32 Zähne 1/4" 1,1 mm	Chain 32 teeth 1/4" 1,1 mm	12,35-
7	320/2	Spranga 15,5 cm / 5"	Barra guía 15,5 cm / 5"	Schwert 15,5 cm / 5"	Guide bar 15,5 cm / 5"	8,45-
8 + 9 + 10 + 11 + 12 + 26 + 27x9 + 38	320/3	Set copertura per motosega	Juego de fundas para motosierras	Abdeckungset für elektrische Motorsäge	Cover set for chainsaws	7,00-
8 + 9 + 10 + 11 + 12	320/4	Sistema di auto-tensionamento catena	Sistema de autotensado de cadena	Kettenselbstspannsystem	Chain self-tensioning system	1,25-
1 + 2 + 3 + 4 + 5	320/5	Coperchio roccetto catena	Tapa del piñón de cadena	Kettenradabdeckung	Chain sprocket cover	3,45-
16 + 17	320/6	Copertura protettiva 15,5 cm / 5"	Capa protectora flexible 15,5 cm / 5"	Flexible Schutzhülse 15,5 cm / 5"	Protective cover 15,5 cm / 5"	0,95-
33	320/7	Batteria Li-Ion	Batería Li-Ion	Batterie Li-Ion	Li-Ion Battery	40,00-
43	320/8	Caricabatterie doppio	Cargador doble	Zweifach-Ladegerät	Double battery charger	12,00-
15 + 18 + 19 + 20 + 21 + 22 + 23 + 24 + 27x4 + 28 + 39 + 40 + 41	320/9	Motoriduttore con attacco per lama	Motorreductor con conexión para hoja	Reduziergetriebe mit Motor	Geared motor with connection for blade	36,10-
29 + 30 + 34	320/10	Grilletto e tasto di sicurezza	Gatillo y botón de seguridad	Auslöser und Sperrschalter	Trigger with safety button	1,65-
31	320/11	Interruttore	Interruptor	Ein-/Aus-Schalter	Power button	1,05-
32 + 35 + 36 + 37	320/12	Circuito stampato con interruttore ON/OFF con indicatori LED	Circuito impreso con ON/OFF interruptor y indicador LED	Leiterplatte mit ON/OFF-Schalter und LED-Anzeige	Printed circuit board with ON/OFF button and LED indicator	26,25-
32	320/14	Contatti per batteria	Contactos batería	Batteriekontakte	Battery contacts	1,40-
13x3 + 14	320/15	Protezione frontale antiurto	Protección contra impactos frontales	Frontaufprallschutz	Front impact protection	3,25-
39 + 40 + 41	320/16	Pignone con rondella	Piñon con arandela	Ritzel mit Unterlegscheibe	Sprocket with washer	4,85-
13x3 + 15 + 17 + 27x13	320/17	Kit viti completo	Kit tornillos completo	Kit Schrauben komplett	Complete screws kit	2,30-
42	320/18	Fodero catena 15,5 cm / 5"	Funda cadena 15,5 cm / 5"	Transportschutz für Schwert 15,5 cm / 5"	Chain sheath 15,5 cm / 5"	1,55-



- Ⓘ Ricambi
- Ⓔ Recambios
- Ⓓ Ersatzteile
- Ⓒ Spare parts

Art. 403

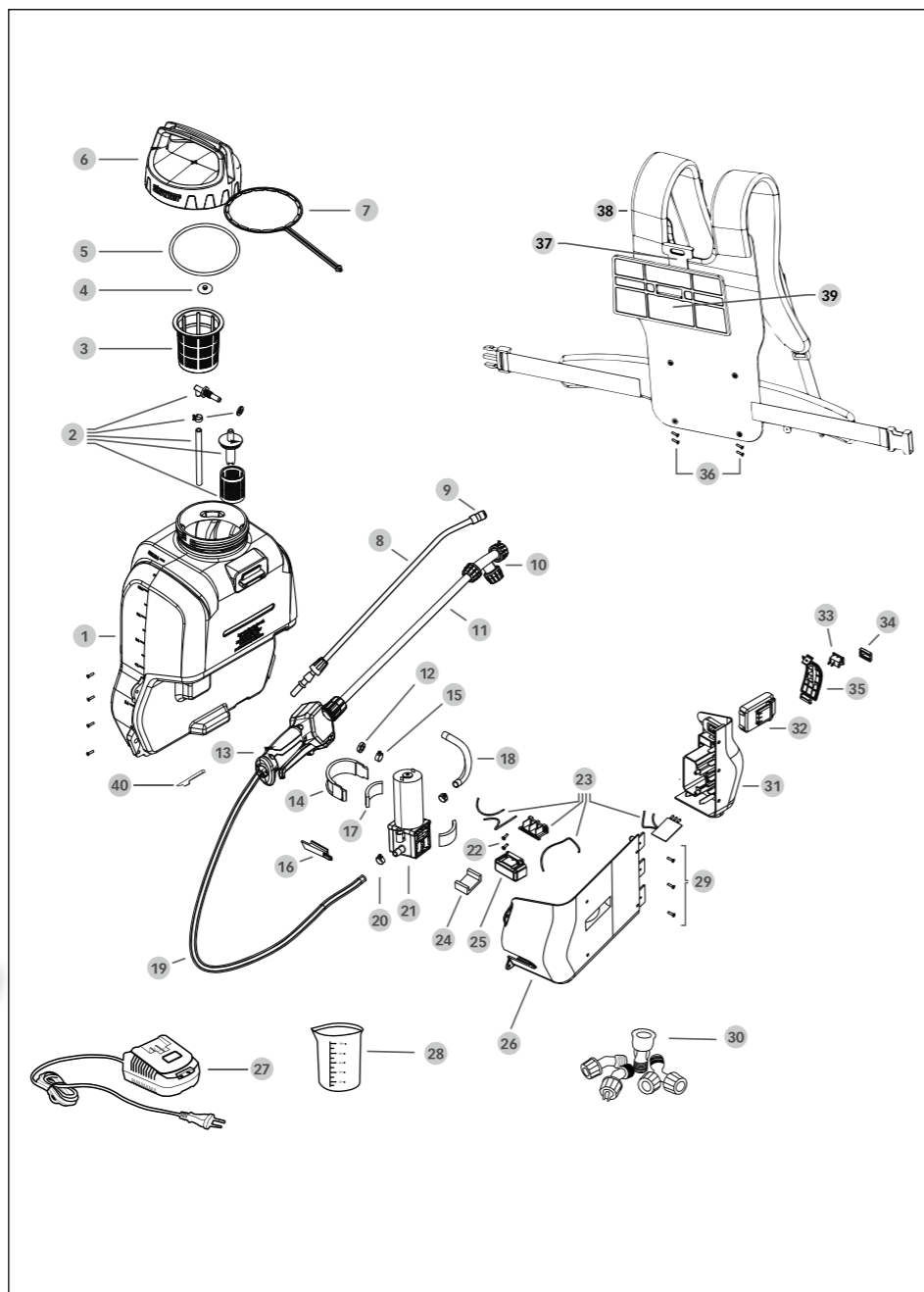

- Ⓘ Ricambi
- Ⓔ Recambios
- Ⓓ Ersatzteile
- Ⓒ Spare parts

Art. 225, 229

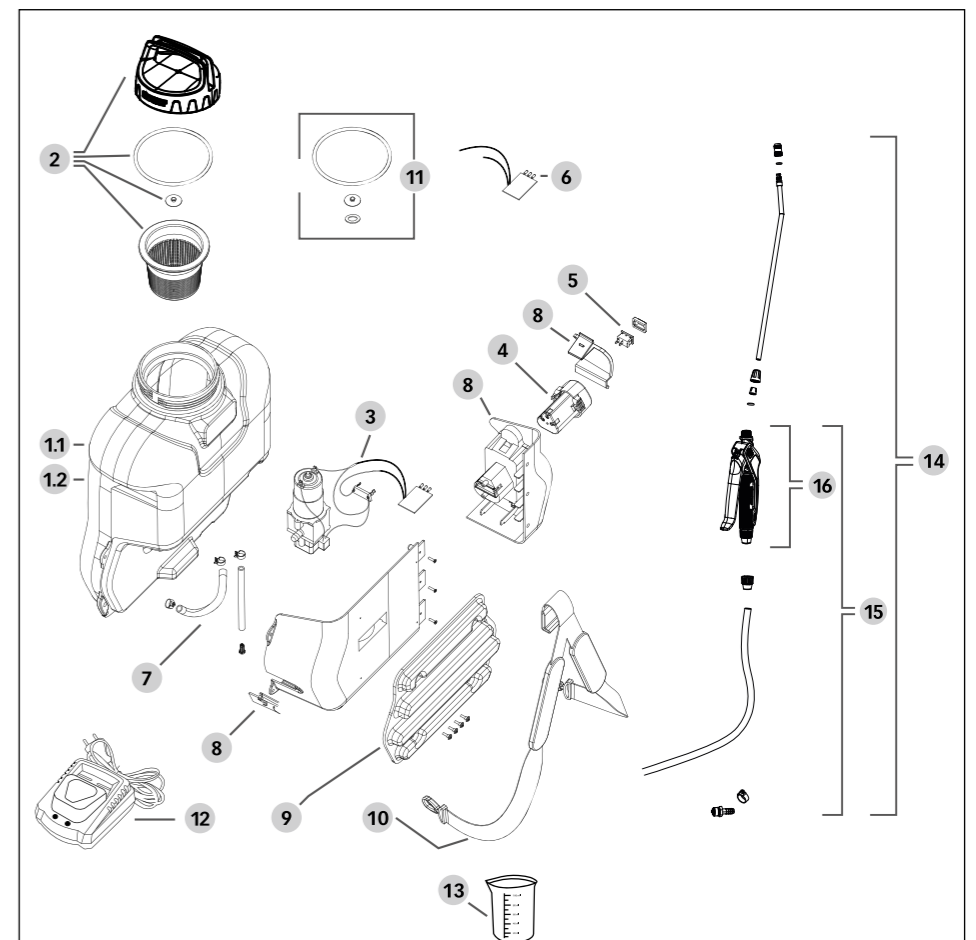

- Ⓘ Per questa serie di pompe esiste la possibilità di acquistare varie misure di serbatoi, come indicato sotto:
- Ⓔ Para esta serie de bombas es posible comprar diversos tamaños de tanques, como se muestra a continuación:
- Ⓓ Für diese Rückenspritzmodelle sind folgende Behälter in verschiedenen Größen erhältlich:
- Ⓒ For these backpack sprayer models you can purchase the following different tank sizes:



Serbatoio 12 l
Tanque 12 l
Tank 12 l
Art. 239/1



Serbatoio 15 l
Tanque 15 l
Tank 15 l
Art. 236/1

#	Art.	IT	ES	DE	EN	€
1	403/1	Serbatoio 15 L	Tanque 15 L	Tank 15 L	Tank 15 L	37,00-
23 + 21	403/2	Motore e circuito stampato	Motor y circuito impreso	Motor und Leiterplatte	Printed circuit board and engine	68,30-
23 + 13 + 20 + 19	403/3	Tubo e impugnatura	Tubo e empuñadura	Schlauch und Griff	Tube and handle	32,30-
11 + 10	403/4	Lancia in fibra di vetro	Lanza de fibra de vidrio	Fiberglas-Sprühlanze	Fiberglass lance	20,10-
23 + 13 + 20 + 11 + 10 + 19	403/5	Lancia in fibra di vetro con tubo, impugnatura e ugello	Lanza de fibra de vidrio con tubo, empuñadura y boquilla	Fiberglas-Sprühlanze mit Schlauch, Griff und Düse	Fiberglass lance with tube, handle and nozzle	37,00-
10	403/6	Ugello nebulizzazione ultra fine	Boquilla nebulización ultra fina	Düse mit ultra-feiner Nebelstrahlfunktion	Ultra-fine nebulization nozzle	16,50-
26 + 31 + 35 + 25 + 16 + 14 + 29x3 + 22x2 + 17 + 24	403/7	Base serbatoio in plastica	Base tanque de plástico	Kunststoffabdeckung	Plastic tank base	14,60-
12 + 15x2 + 18 + 2	403/8	Set tubo mandata serbatoio	Set tubo entrada tanque	Set Tank-Verbindungsschlauch	Tank delivery hose set	3,10-
23	403/9	Circuito stampato	Circuito impreso	Leiterplatte	Printed circuit board	16,40-
40	403/10	Blocco spruzzo per impugnatura	Bloqueo pulverización para empuñadura	Einrastzapfen für Griff	Spraying-lock for handle	0,70-
6 + 4 + 3 + 5 + 7	226/2	Chiusura serbatoio (Tappo, filtro e guarnizione)	Cierre tanque (Tapón, filtro y junta)	Verschluss Tank (Verschluss, Filter und Dichtung)	Tank cap (Cap, filter and seal)	6,60-
32	226/4	Batteria Li-Ion	Batería Li-Ion	Batterie Li-Ion	Li-Ion Battery	76,90-
33 + 34	226/5	Interruttore	Interruptor	Ein-/Ausschalter	Power button	0,70-
27	226/10	Caricabatteria	Cargador	Ladegerät	Battery charger	39,20-
-	226/11	Set guarnizioni in FPM	Set juntas de FPM	Set FPM-Dichtungen	FPM-seals set	17,70-
8	226/13	Lancia in alluminio	Lanza de aluminio	Aluminium-Sprühlanze	Aluminium lance	14,60-
9	226/16	Ugello regolabile getto diretto o nebulizzazione	Boquilla ajustable chorro directo o nebulización	Regulierbare Düse mit Nebel- und Stehstrahlfunktion	Adjustable nozzle direct jet or nebulization	2,10-
30	D-259	Set ugelli	Set boquillas	Düsen-set	Nozzles set	5,30-
28	237/17	Misurino dosatore graduato	Vaso medidor graduado	Messbecher mit Maßanzeige	Graduated measuring cup	0,70-
38	424	Bastino per pompa da 15 L	Portador para bomba de 15 L	Schultergurt für Rückenspritze zu 15 L	Shoulder harness for 15 L sprayer	36,85-
37 + 36x4	423/1	Set viti e blocco	Set tornillos y bloqueo	Schraubenset und Stopper	Screws and locking piece set	2,90-
39	423/2	Placca di supporto per schienale	Placa de soporte para respaldo	Stützplatte für Rückenstück	Support plate for back	6,20-

#	Art.	IT	ES	DE	EN	€
1.1	236/1	Serbatoio 15 L	Tanque 15 L	Tank 15 L	Tank 15 L	34,20-
1.2	239/1	Serbatoio 12 L	Tanque 12 L	Tank 12 L	Tank 12 L	32,20-
2	237/2	Chiusura serbatoio (Tappo, filtro e guarnizione)	Cierre tanque (Tapón, filtro y junta)	Tank-Deckel (Verschluss, Filter und Dichtung)	Tank cap (Cap, filter and seal)	4,70-
3	235/1	Motore e circuito stampato	Motor y circuito impreso	Motor mit Leiterplatte	Engine and printed circuit board	50,10-
4	235/2	Batteria Li-Ion	Batería Li-Ion	Batterie Li-Ion	Li-Ion Battery	46,15-
5	237/5	Interruttore	Interruptor	Ein-/Aus-Schalter	Power button	2,20-
6	237/6	Circuito stampato	Circuito impreso	Leiterplatte	Printed circuit board	8,00-
7	237/7	Set tubo mandata serbatoio con fascette e filtro	Set tubo entrada tanque con abrazaderas y filtro	Set Tank-Verbindungsschlauch mit Schellen und Filter	Tank delivery hose set with clamps and filter	3,70-
8	237/8	Base serbatoio in plastica	Base tanque de plástico	Kunststoff-Untersatz	Plastic tank base	6,30-
9	237/9	Cuscinetto	Almohadilla	Rückenpolster	Pad	6,00-
10	237/10	Cinghie	Correas	Gurte	Shoulder strap	9,90-
11	237/11	Set o-ring	Set O-Rings	Set O-ring	O-Rings set	2,80-
12	237/12	Caricabatteria	Cargador	Ladegerät	Battery charger	34,90-
13	237/17	Misurino dosatore graduato	Vaso medidor graduado	Messbecher mit Maßanzeige	Graduated measuring cup	0,70-
14 + 15 + 16 + 17 + 18 + 19 + 20 + 21 + 22 + 23 + 24	404/10	Lancia in fibra di vetro con tubo, impugnatura, ugello e guarnizioni in FPM	Lanza de fibra de vidrio con tubo, empuñadura, boquillas y juntas de FPM	Fiberglas-Sprühlanze mit Schlauch, Griff, Düse und FPM-Dichtungen	Fiberglass lance with handle, tube, nozzle and FPM-seals	15,25-
14 + 15 + 16 + 2x17 + 18	404/11	Tubo e impugnatura con guarnizioni in FPM	Tubo e empuñadura con juntas de FPM	Schlauch und Griff mit FPM-Dichtung	Tube and handle with FPM-seals	19,00-
17 + 18	404/14	Impugnatura	Empuñadura	Griff	Handle	12,40-



- Ⓘ Ricambi
- Ⓔ Recambios
- Ⓓ Ersatzteile
- Ⓒ Spare parts

Art. 226, 227, 228

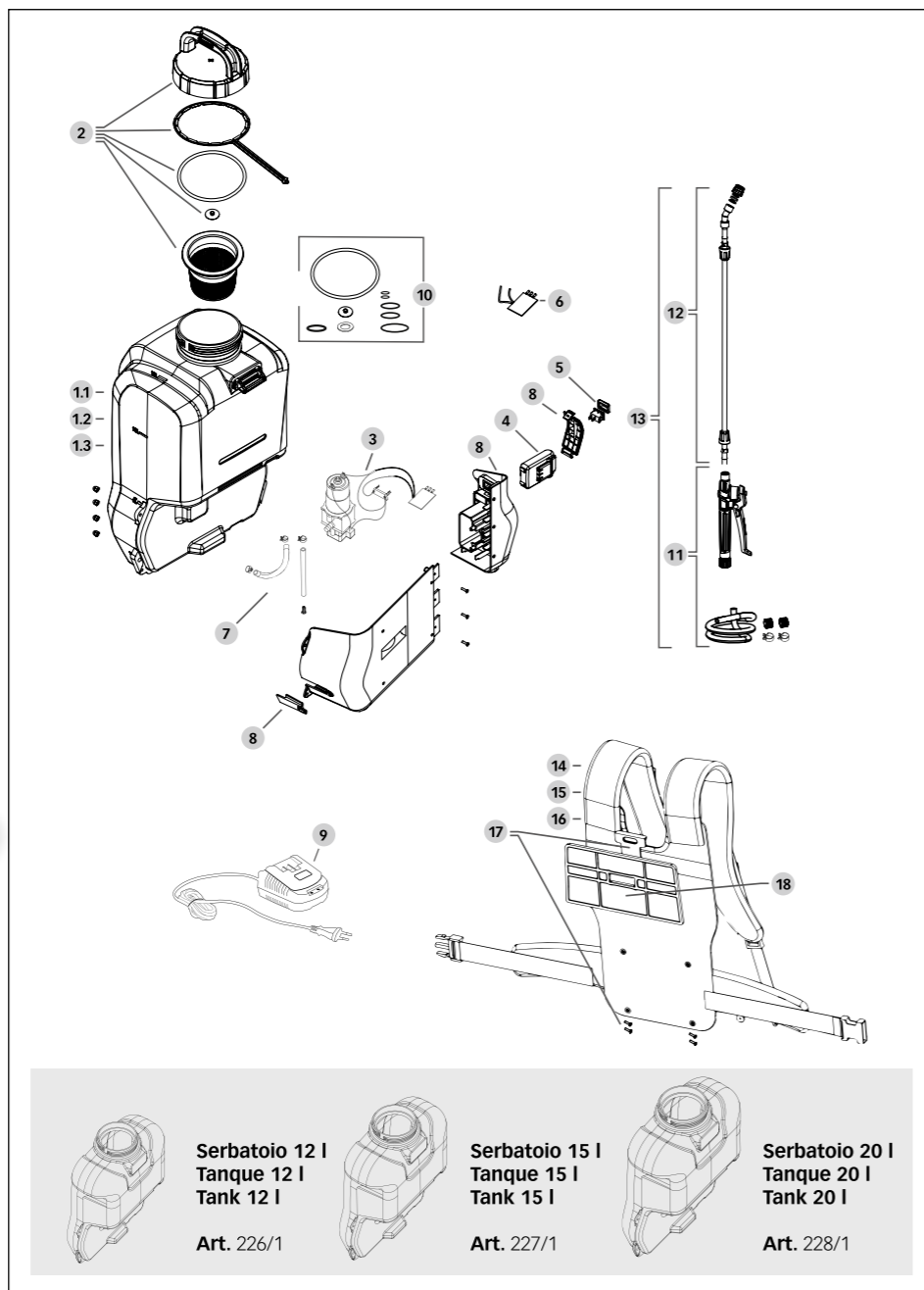

Serbatoio 12 l
Tanque 12 l
Tank 12 l
Art. 226/1

Serbatoio 15 l
Tanque 15 l
Tank 15 l
Art. 227/1

Serbatoio 20 l
Tanque 20 l
Tank 20 l
Art. 228/1

#	Art.	IT	ES	DE	EN	€
1.1	226/1	Serbatoio 12 L	Tanque 12 L	Tank 12 L	Tank 12 L	34,20-
1.2	227/1	Serbatoio 15 L	Tanque 15 L	Tank 15 L	Tank 15 L	36,60-
1.3	228/1	Serbatoio 20 L	Tanque 20 L	Tank 20 L	Tank 20 L	40,50-
2	226/2	Chiusura serbatoio (Tappo, filtro e guarnizione)	Cierre tanque (Tapón, filtro y junta)	Verschluss Tank (Verschluss, Filter und Dichtung)	Tank cap (Cap, filter and seal)	6,60-
3	226/3	Motore e circuito stampato	Motor y circuito impreso	Motor und Leiterplatte	Printed circuit board and engine	63,20-
4	226/4	Batteria Li-Ion	Batería Li-Ion	Batterie Li-Ion	Li-Ion Battery	76,90-
5	226/5	Interruttore	Interruptor	Ein-/Aus-Schalter	Power button	0,70-
6	226/6	Circuito stampato	Circuito impreso	Leiterplatte	Printed circuit board	15,10-
7	226/7	Set tubo mandata serbatoio con fascette e filtro	Set tubo entrada tanque con abrazaderas y filtro	Set Tank-Verbindungsschlauch mit Schellen und Filter	Tank delivery hose set with clamps and filter	3,00-
8	226/8	Base serbatoio in plastica	Base tanque de plástico	Kunststoffabdeckung	Plastic tank base	14,20-
9	226/10	Caricabatteria	Cargador	Ladegerät	Battery charger	39,20-
10	226/11	Set guarnizioni in FPM	Set juntas de FPM	Set FPM-Dichtungen	FPM-seals set	17,70-
11	226/15	Tubo e impugnatura con guarnizioni in FPM	Tubo y empuñadura con juntas de FPM	Schlauch und Griff mit FPM-Dichtung	Tube and handle with FPM-seals	11,60-
12	226/14	Lancia in fibra di vetro con guarnizioni in FPM	Lanza de fibra de vidrio con juntas de FPM	Fiberglas-Sprühlanze mit FPM-Dichtung	Fiberglass lance with FPM-seals	13,90-
13	226/12	Lancia in fibra di vetro con tubo, impugnatura, set ugelli (Art. D-259) e guarnizioni in FPM	Lanza de fibra de vidrio con tubo, empuñadura, set boquillas (art. D-259) y juntas de FPM	Fiberglas-Sprühlanze mit Schlauch, Griff, Düsen-set (Art. D-259) und FPM-Dichtungen	Fiberglass lance with handle, tube, nozzles set (Item D-259) and FPM-seals	15,60-
14	423	Bastino per pompa da 12 L	Portador para bomba de 12 L	Schultergurt für Rückenspritze zu 12 L	Shoulder harness for 12 L sprayer	35,80-
15	424	Bastino per pompa da 15 L	Portador para bomba de 15 L	Schultergurt für Rückenspritze zu 15 L	Shoulder harness for 15 L sprayer	36,85-
16	425	Bastino per pompa da 20 L	Portador para bomba de 20 L	Schultergurt für Rückenspritze zu 20 L	Shoulder harness for 20 L sprayer	37,50-
17	423/1	Set viti e blocco	Set tornillos y bloqueo	Schraubenset und Stopper	Screws and locking piece set	2,90-
18	423/2	Placca di supporto per schienale	Placa de soporte para respaldo	Stützplatte für Rückenstück	Support plate for back	6,20-



- Ⓘ Ricambi
- Ⓔ Recambios
- Ⓓ Ersatzteile
- Ⓒ Spare parts

Art. 235, 236

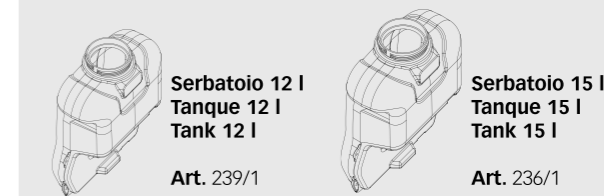
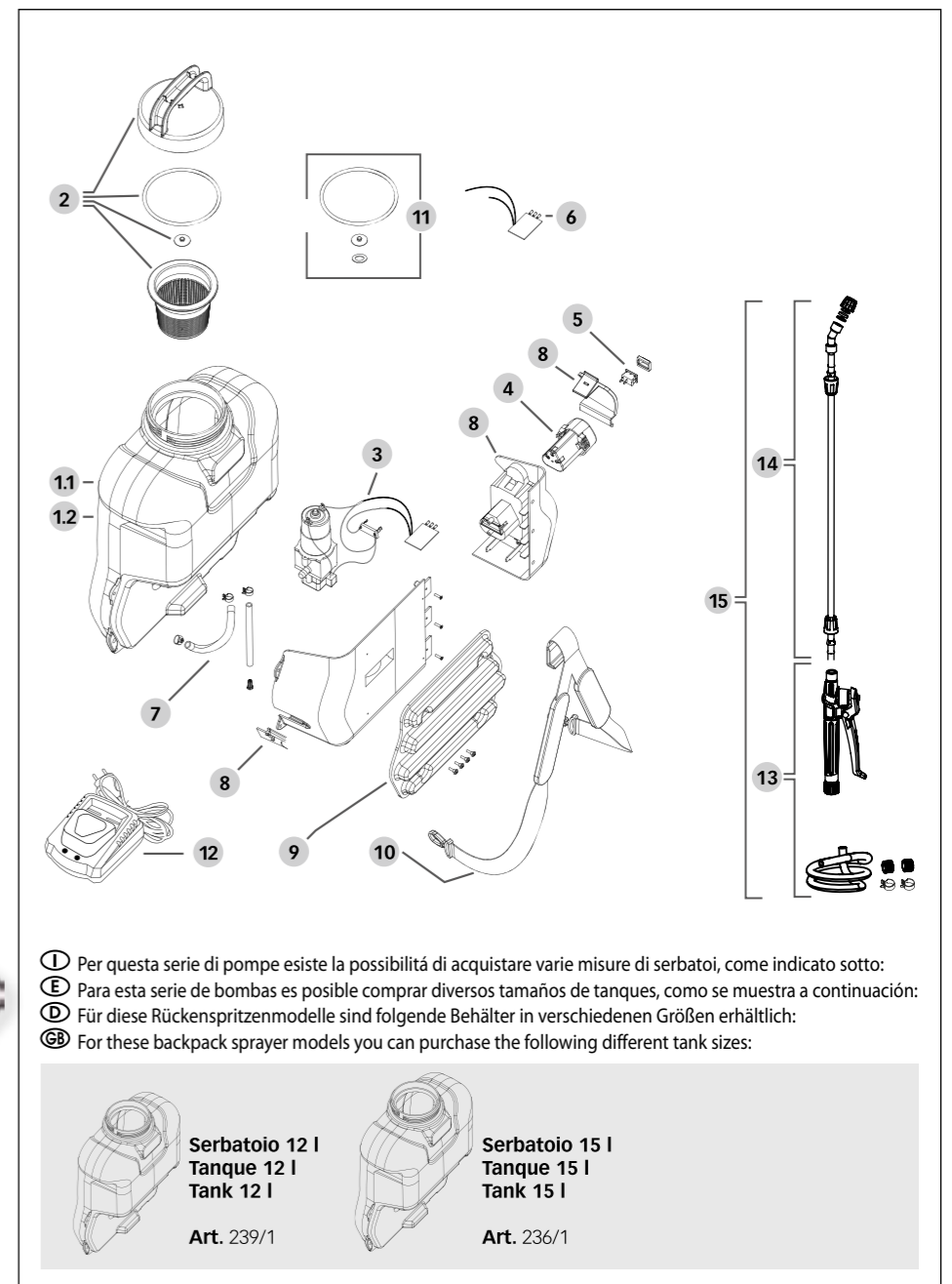

Serbatoio 12 l
Tanque 12 l
Tank 12 l
Art. 239/1

Serbatoio 15 l
Tanque 15 l
Tank 15 l
Art. 236/1

- Ⓘ Per questa serie di pompe esiste la possibilità di acquistare varie misure di serbatoi, come indicato sotto:
- Ⓔ Para esta serie de bombas es posible comprar diversos tamaños de tanques, como se muestra a continuación:
- Ⓓ Für diese Rückenspritzenmodelle sind folgende Behälter in verschiedenen Größen erhältlich:
- Ⓒ For these backpack sprayer models you can purchase the following different tank sizes:

#	Art.	IT	ES	DE	EN	€
1.1	236/1	Serbatoio 15 L	Tanque 15 L	Tank 15 L	Tank 15 L	34,20-
1.2	239/1	Serbatoio 12 L	Tanque 12 L	Tank 12 L	Tank 12 L	32,20-
2	237/2	Chiusura serbatoio (Tappo, filtro e guarnizione)	Cierre tanque (Tapón, filtro y junta)	Tank-Deckel (Verschluss, Filter und Dichtung)	Tank cap (Cap, filter and seal)	4,70-
3	235/1	Motore e circuito stampato	Motor y circuito impreso	Motor mit Leiterplatte	Engine and printed circuit board	50,10-
4	235/2	Batteria Li-Ion	Batería Li-Ion	Batterie Li-Ion	Li-Ion Battery	46,15-
5	237/5	Interruttore	Interruptor	Ein-/Aus-Schalter	Power button	2,20-
6	237/6	Circuito stampato	Circuito impreso	Leiterplatte	Printed circuit board	8,00-
7	237/7	Set tubo mandata serbatoio con fascette e filtro	Set tubo entrada tanque con abrazaderas y filtro	Set Tank-Verbindungsschlauch mit Schellen und Filter	Tank delivery hose set with clamps and filter	3,70-
8	237/8	Base serbatoio in plastica	Base tanque de plástico	Kunststoff-Untersatz	Plastic tank base	6,30-
9	237/9	Cuscinetto	Almohadilla	Rückenpolster	Pad	6,00-
10	237/10	Cinghie	Correas	Gurte	Shoulder strap	9,90-
11	237/11	Set o-ring	Set O-Rings	Set O-ring	O-Rings set	2,80-
12	237/12	Caricabatteria	Cargador	Ladegerät	Battery charger	34,90-
13	237/15	Tubo e impugnatura	Tubo y empuñadura	Schlauch und Griff	Tube and handle	7,30-
14	242/36	Lancia in fibra di vetro	Lanza de fibra de vidrio	Fiberglas-Sprühlanze	Fiberglass lance	7,30-
15	237/14	Lancia in fibra di vetro con tubo, impugnatura, set ugelli (Art. D-259)	Lanza de fibra de vidrio con tubo, empuñadura, set boquillas (art. D-259)	Fiberglas-Sprühlanze mit Schlauch, Griff, Düsen-set (Art. D-259)	Fiberglass lance with handle, tube, nozzles set (Item D-259)	13,00-



- ① Ricambi
- Ⓔ Recambios
- Ⓓ Ersatzteile
- Ⓒ Spare parts

Art. 230

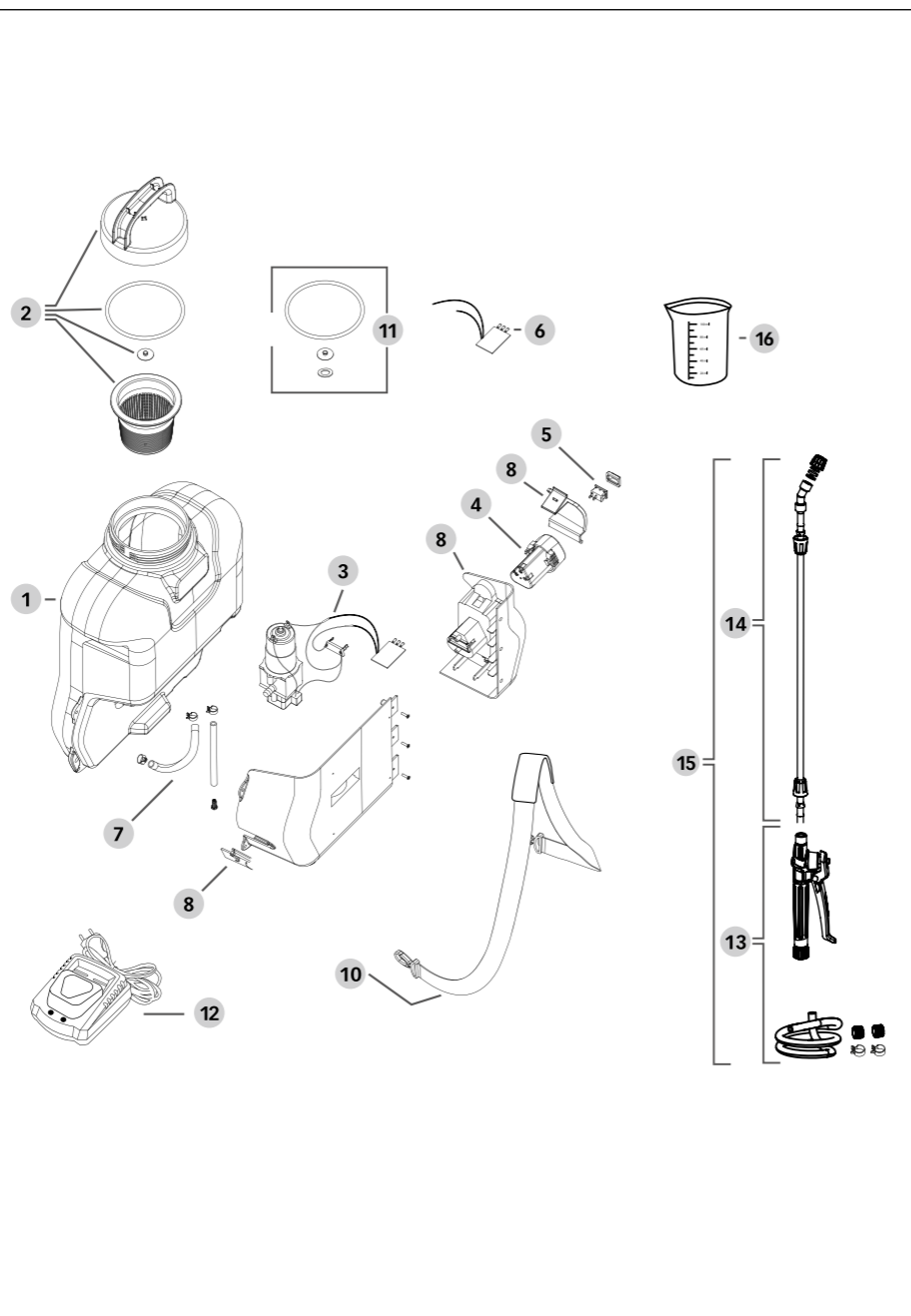

#	Art.	IT	ES	DE	EN	€
1	230/2	Serbatoio 5 L	Tanque 5 L	Tank 5 L	Tank 5 L	18,50-
2	237/2	Chiusura serbatoio (Tappo, filtro e guarnizione)	Cierre tanque (Tapón, filtro y junta)	Tank-Deckel (Verschluss, Filter und Dichtung)	Tank cap (Cap, filter and seal)	4,70-
3	237/3	Motore e circuito stampato	Motor y circuito impreso	Motor und Leiterplatte	Engine and printed circuit board	40,10-
4	237/4	Batteria Li-Ion	Batería Li-Ion	Batterie Li-Ion	Li-Ion Battery	50,50-
5	237/5	Interruttore	Interruptor	Ein-/Aus-Schalter	Power button	2,20-
6	237/6	Circuito stampato	Circuito impreso	Leiterplatte	Printed circuit board	8,00-
7	237/7	Set tubo mandata serbatoio con fascette e filtro	Set tubo entrada tanque con abrazaderas y filtro	Set Tank-Verbindungsschlauch mit Schellen und Filter	Tank delivery hose set with clamps and filter	3,70-
8	237/8	Base serbatoio in plastica	Base tanque de plástico	Kunststoff-Untersatz	Plastic tank base	6,30-
10	230/1	Cinghia	Correa	Gurt	Shoulder strap	6,60-
11	237/11	Set o-ring	Set O-Rings	Set O-ring	O-Rings set	2,80-
12	237/12	Caricabatteria	Cargador	Ladegerät	Battery charger	34,90-
13	237/15	Tubo e impugnatura	Tubo y empuñadura	Schlauch und Griff	Tube and handle	7,30-
14	242/36	Lancia in fibra di vetro	Lanza de fibra de vidrio	Fiberglas-Sprühlanze	Fiberglass lance	7,30-
15	237/14	Lancia in fibra di vetro con tubo, impugnatura, set ugelli (Art. D-259)	Lanza de fibra de vidrio con tubo, empuñadura, set boquillas (art. D-259)	Fiberglas-Sprühlanze mit Schlauch, Griff, Düsen-set (Art. D-259)	Fiberglass lance with handle, tube, nozzles set (Item D-259)	13,00-
16	237/17	Misurino dosatore graduato	Vaso medidor graduado	Messbecher mit Maßanzeige	Graduated measuring cup	0,70-



- ① Ricambi
- Ⓔ Recambios
- Ⓓ Ersatzteile
- Ⓒ Spare parts

Art. 237, 238, 239, 1239

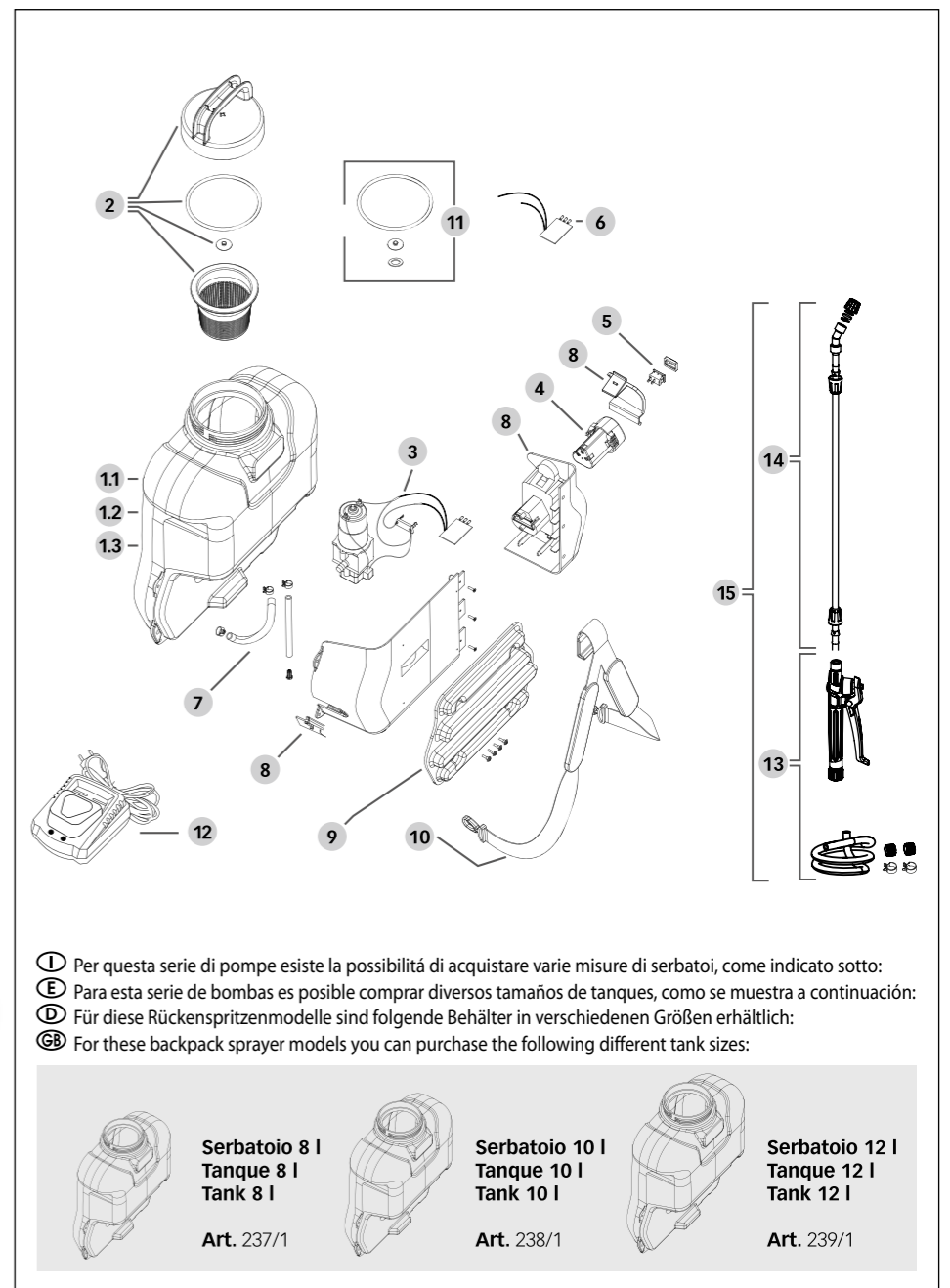

- ① Per questa serie di pompe esiste la possibilità di acquistare varie misure di serbatoi, come indicato sotto:
- Ⓔ Para esta serie de bombas es posible comprar diversos tamaños de tanques, como se muestra a continuación:
- Ⓓ Für diese Rückenspritzmodelle sind folgende Behälter in verschiedenen Größen erhältlich:
- Ⓒ For these backpack sprayer models you can purchase the following different tank sizes:



#	Art.	IT	ES	DE	EN	€
1.1	237/1	Serbatoio 8 L	Tanque 8 L	Tank 8 L	Tank 8 L	21,30-
1.2	238/1	Serbatoio 10 L	Tanque 10 L	Tank 10 L	Tank 10 L	26,80-
1.3	239/1	Serbatoio 12 L	Tanque 12 L	Tank 12 L	Tank 12 L	32,20-
2	237/2	Chiusura serbatoio (Tappo, filtro e guarnizione)	Cierre tanque (Tapón, filtro y junta)	Tank-Deckel (Verschluss, Filter und Dichtung)	Tank cap (Cap, filter and seal)	4,70-
3	237/3	Motore e circuito stampato	Motor y circuito impreso	Motor und Leiterplatte	Engine and printed circuit board	40,10-
4	237/4	Batteria Li-Ion	Batería Li-Ion	Batterie Li-Ion	Li-Ion Battery	50,50-
5	237/5	Interruttore	Interruptor	Ein-/Aus-Schalter	Power button	2,20-
6	237/6	Circuito stampato	Circuito impreso	Leiterplatte	Printed circuit board	8,00-
7	237/7	Set tubo mandata serbatoio con fascette e filtro	Set tubo entrada tanque con abrazaderas y filtro	Set Tank-Verbindungsschlauch mit Schellen und Filter	Tank delivery hose set with clamps and filter	3,70-
8	237/8	Base serbatoio in plastica	Base tanque de plástico	Kunststoff-Untersatz	Plastic tank base	6,30-
9	237/9	Cuscinetto	Almohadilla	Rückenpolster	Pad	6,00-
10	237/10	Cinghie	Correas	Gurte	Shoulder strap	9,90-
11	237/11	Set o-ring	Set O-Rings	Set O-ring	O-Rings set	2,80-
12	237/12	Caricabatteria	Cargador	Ladegerät	Battery charger	34,90-
13	237/15	Tubo e impugnatura	Tubo y empuñadura	Schlauch und Griff	Tube and handle	7,30-
14	242/36	Lancia in fibra di vetro	Lanza de fibra de vidrio	Fiberglas-Sprühlanze	Fiberglass lance	7,30-
15	237/14	Lancia in fibra di vetro con tubo, impugnatura, set ugelli (Art. D-259)	Lanza de fibra de vidrio con tubo, empuñadura, set boquillas (art. D-259)	Fiberglas-Sprühlanze mit Schlauch, Griff, Düsen-set (Art. D-259)	Fiberglass lance with handle, tube, nozzles set (Item D-259)	13,00-



- ① Ricambi
- Ⓔ Recambios
- Ⓓ Ersatzteile
- Ⓒ Spare parts

Art. 1239/1

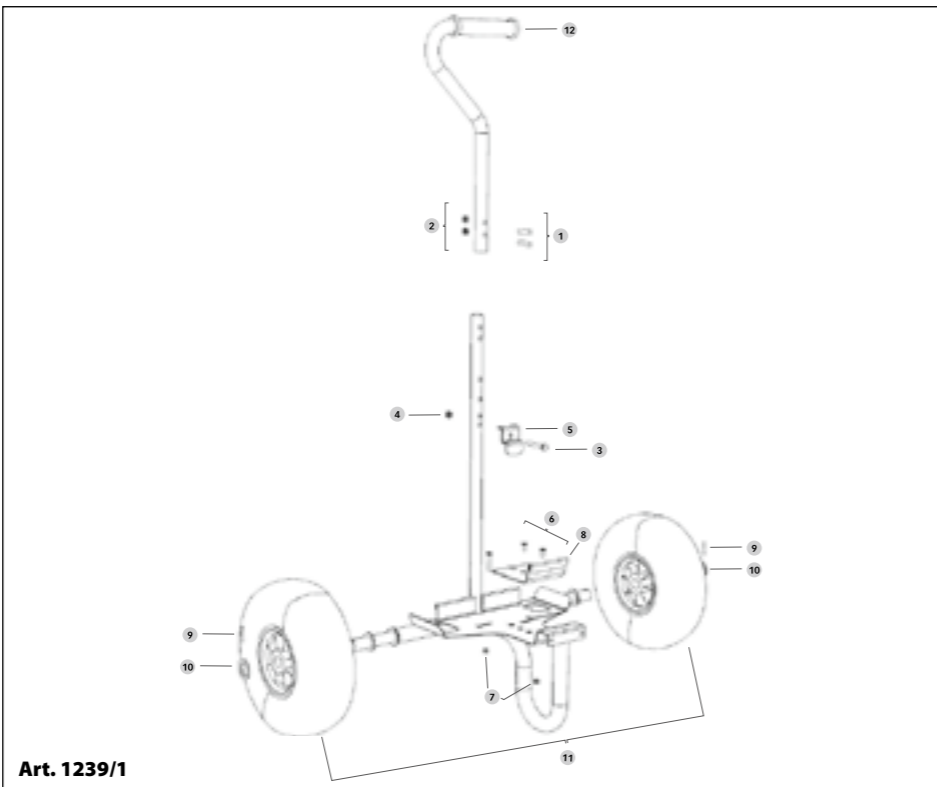

Art. 1239/1

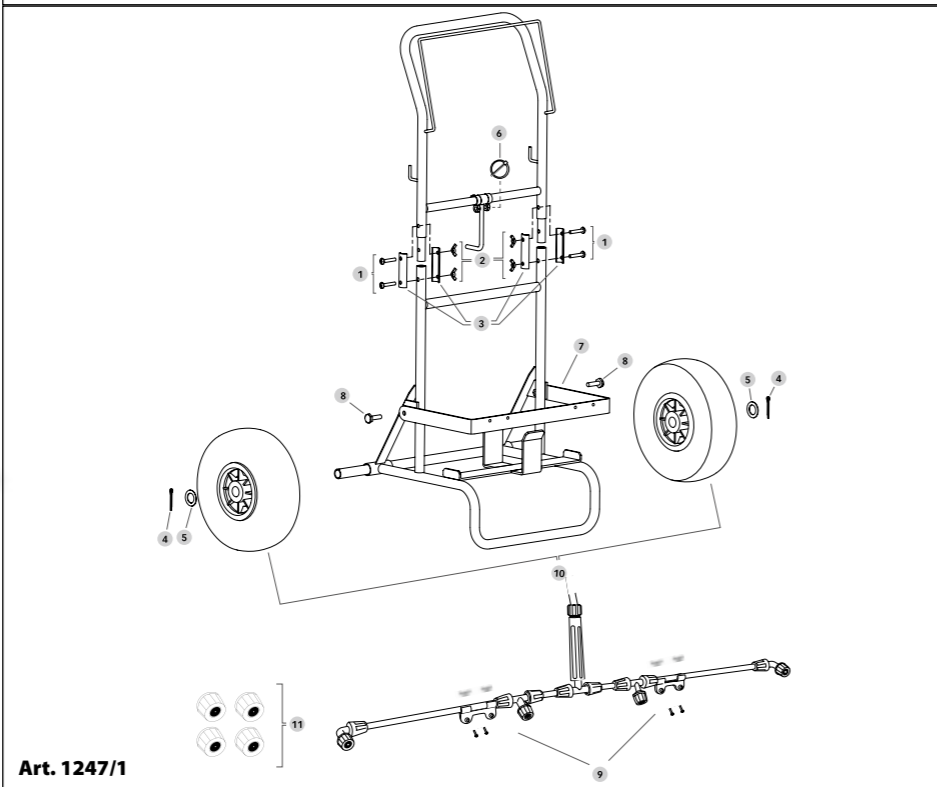

Art. 1247/1

#	Art.	IT	ES	DE	EN	€
6x2 + 7x2 + 8	1239/2	Piastra con bulloni	Placa con bulones	Scheibe mit Bolzen	Plate with bolts	10,70-
3 + 4 + 5	1239/3	Aggancio con bullone	Enganche con bulón	Halterung mit Bolzen	Hook with bolt	8,65-
11x2	1239/4	Ruota	Rueda	Rad	Wheel	21,55-
1x2 + 2x2 + 3 + 4 + 9x2 + 10x2 + 7x2 + 6x2	1239/5	Kit bulloni	Kit bulones	Kit Bolzen	Bolts kit	8,65-
12	1239/6	Gommino e tappo per impugnatura	Gomita y tapón para empuñadura	Griffgummi und Abdeckung	Rubber and cap for handle	4,25-

Art. 1247/1

#	Art.	IT	ES	DE	EN	€
10x2	1247/2	Ruote	Ruedas	Räder	Wheels	27,10-
1x4 + 2x4 + 3x4 + 6 + 4x2 + 5x2	1247/3	Kit viti e bulloni	Kit tornillos y bulones	Kit Schrauben und Bolzen	Screws and bolts kit	6,75-
7 + 8x2 + 9	1247/4	Barra d'irrigazione per tappeti erbosi	Barra de irrigación para céspedes	Sprühlanze für Grünflächen	Irrigation bar for grass	13,50-
11x4	1247/5	Ugelli nebulizzazione	Boquillas nebulización	Düse mit Nebelfunktion	Nebulization nozzles	4,35-



- ① Ricambi
- Ⓔ Recambios
- Ⓓ Ersatzteile
- Ⓒ Spare parts

Art. 2621

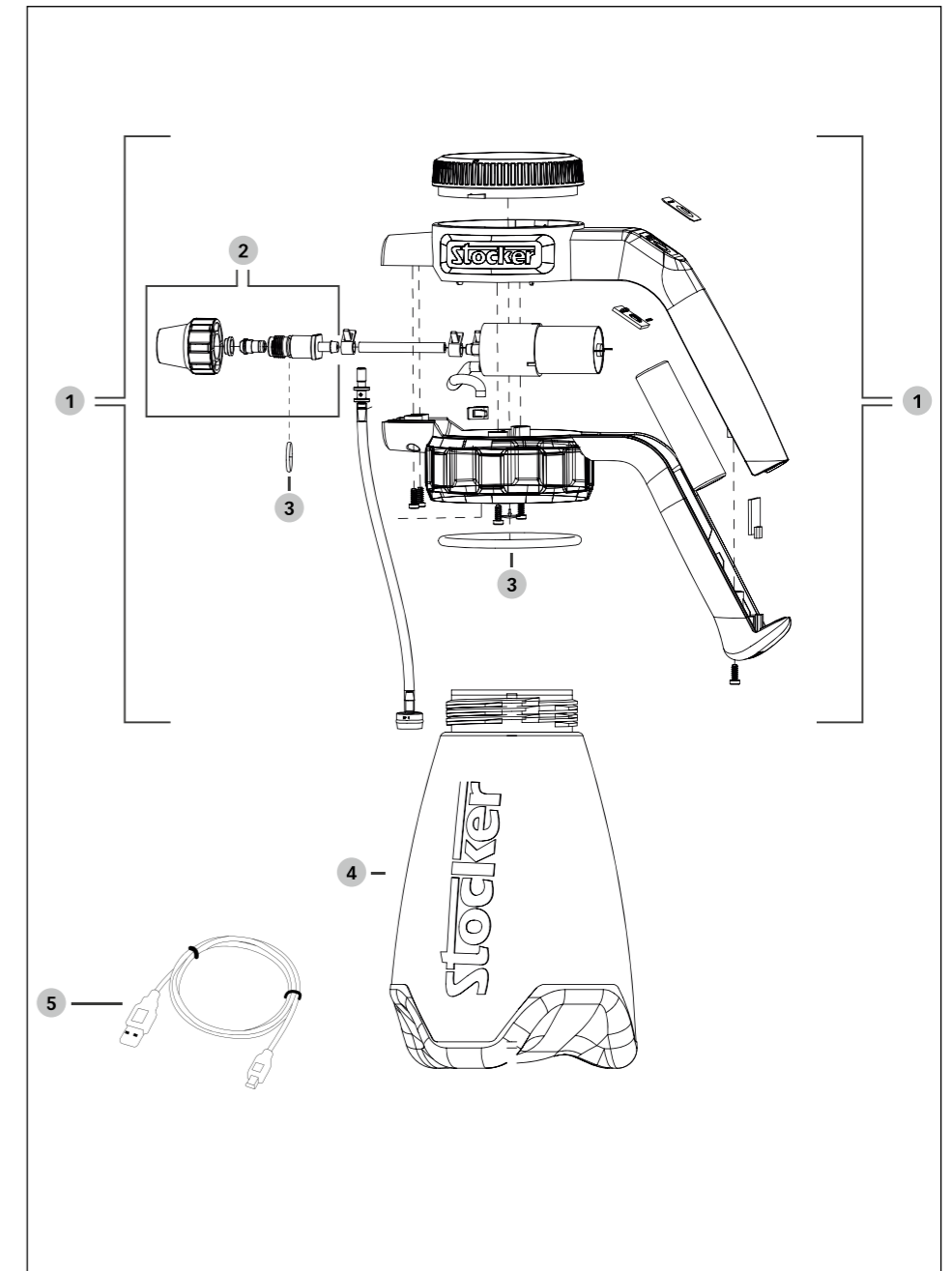

#	Art.	IT	ES	DE	EN	€
1	2621/1	Testa	Cabeza	Sprühkopf	Head	24,00-
2	2621/2	Ugello regolabile getto diretto o nebulizzatore	Boquilla ajustable chorro directo o nebulizador	Regulierbare Düse mit Stechstrahl- und Sprühnebelfunktion	Adjustable nozzle direct jet or nebulizer	4,40-
3	2621/3	Set o-ring	Set o-ring	Set O-ring	O-Rings set	2,60-
4	262/2	Serbatoio 2 L	Tank 2 L	Tanque 2 L	Tank 2 L	7,00-
5	420/3	Cavi USB Micro e USB Type C	Cables Micro USB y USB Type C	Micro USB und USB Type C Kabel	Micro USB and USB Type C cables	2,85-



- Ⓘ Ricambi
- Ⓔ Recambios
- Ⓓ Ersatzteile
- Ⓒ Spare parts

Art. 401, 402

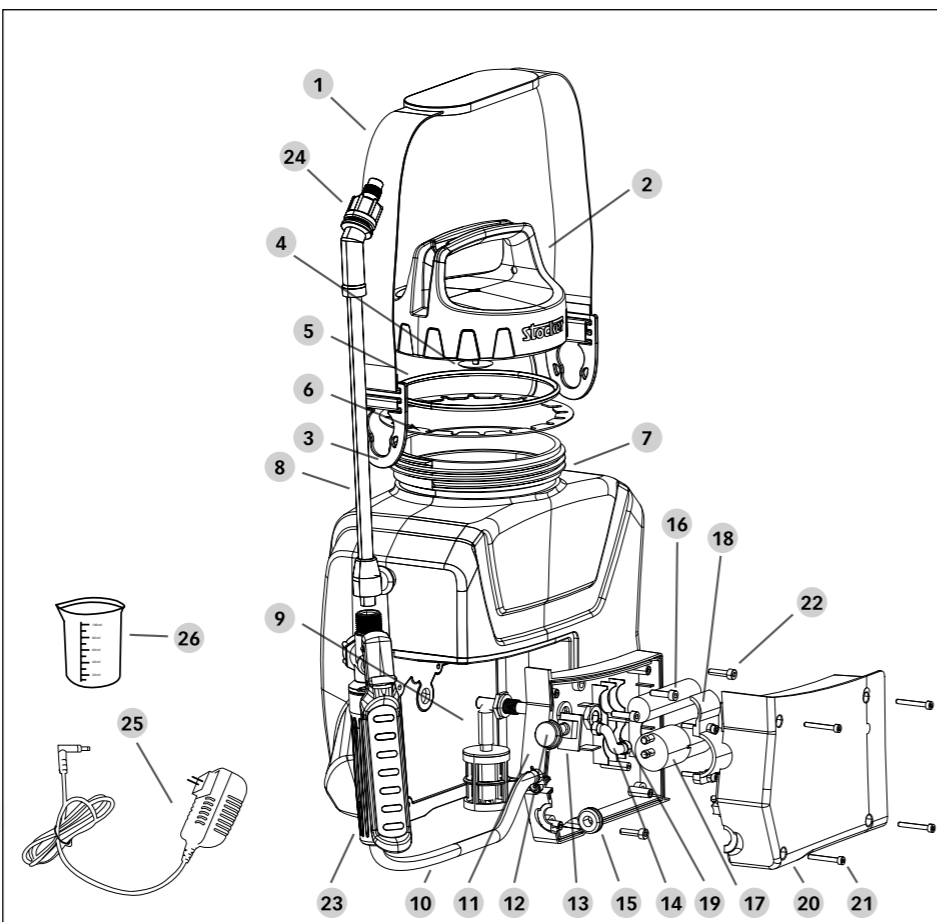

- Ⓘ Per questa serie di pompe esiste la possibilità di acquistare varie misure di serbatoi, come indicato sotto:
- Ⓔ Para esta serie de bombas es posible comprar diversos tamaños de tanques, como se muestra a continuación:
- Ⓓ Für diese Modelle sind folgende Behälter in verschiedenen Größen erhältlich:
- Ⓒ For these sprayer models you can purchase the following different tank sizes:

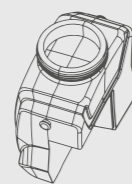

Serbatoio 4 L
Tanque 4 L
Tank 4 L
Art. 401/1

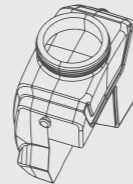

Serbatoio 6 L
Tanque 6 L
Tank 6 L
Art. 402/1



- Ⓘ Ricambi
- Ⓔ Recambios
- Ⓓ Ersatzteile
- Ⓒ Spare parts

Art. 247, 1247

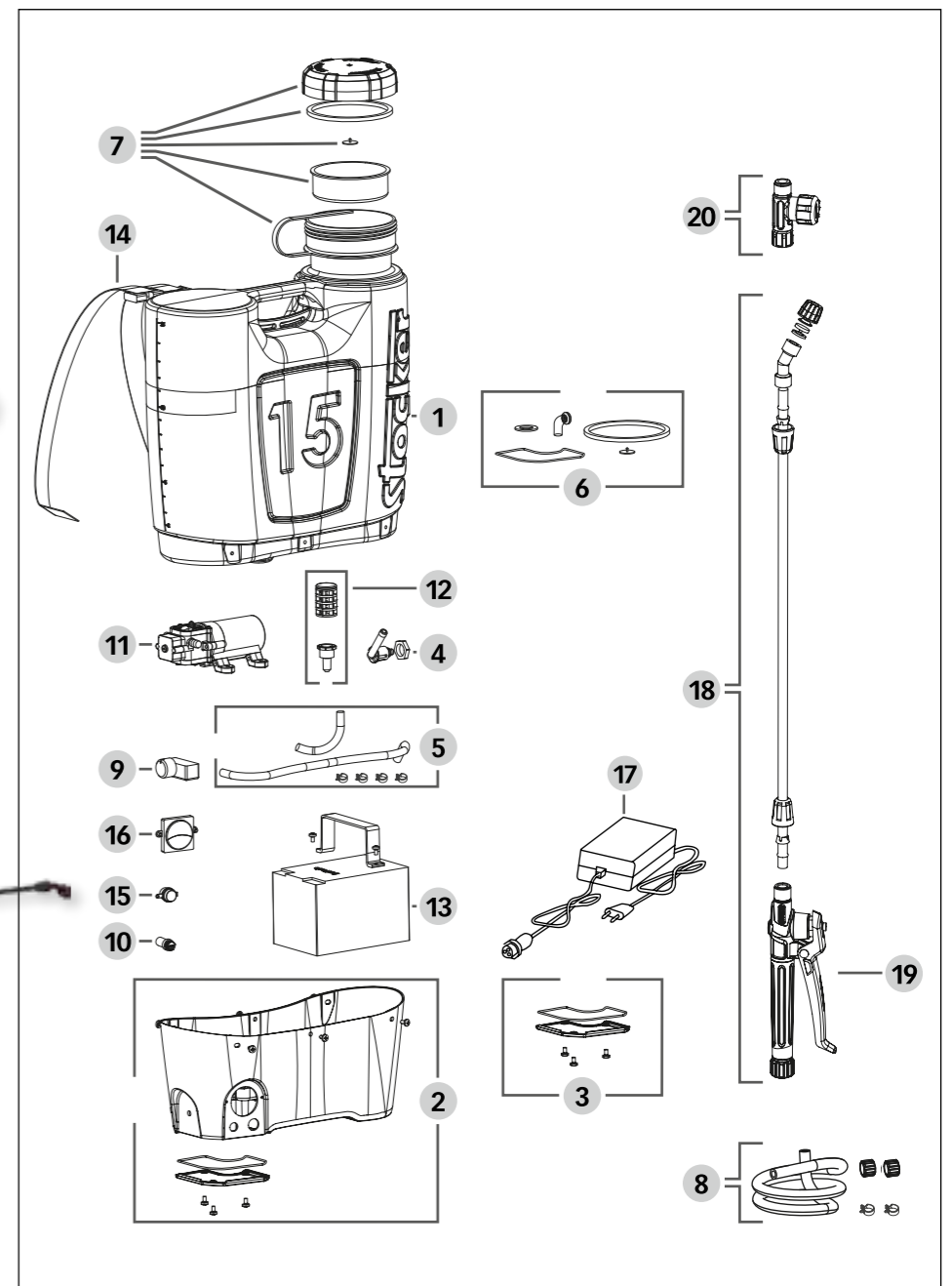

#	Art.	IT	ES	DE	EN	€
7	401/1	Serbatoio 4 L	Tanque 4 L	Tank 4 L	Tank 4 L	15,00-
7	402/1	Serbatoio 6 L	Tanque 6 L	Tank 6 L	Tank 6 L	19,70-
2 + 4 + 5 + 6	237/2	Chiusura serbatoio (Tappo, filtro e guarnizione)	Cierre tanque (Tapón, filtro y junta)	Tank-Deckel (Verschluss, Filter und Dichtung)	Tank cap (Cap, filter and seal)	4,70-
11 + 15 + 18 + 20 + 21x4 + 22x5	401/3	Base serbatoio in plastica	Base tanque de plástico	Kunststoffabdeckung	Plastic tank base	9,10-
16	401/4	Batteria Li-Ion	Batería Li-Ion	Batterie Li-Ion	Li-Ion Battery	7,70-
17	401/5	Motore	Motor	Motor	Engine	9,30-
12 + 13	401/6	Interruttore e circuito stampato	Interruptor y circuito impreso	Ein-/Ausschalter und Leiterplatte	Power button and printed circuit board	9,50-
14x2 + 19x4	401/7	Set tubi di distribuzione	Set tubos de distribución	Verteilerrohr Set	Distribution tubes set	2,60-
9	401/8	Set tubo mandata serbatoio	Set tubo entrada tanque	Set Tank-Verbindungsschlauch	Tank delivery hose set	3,10-
25	401/9	Caricabatteria	Cargador	Ladegerät	Battery charger	13,70-
1 + 3x2	401/10	Cinghia	Correa	Gurt	Shoulder strap	6,50-
10 + 23	237/15	Tubo e impugnatura	Tubo e impugnatura	Schlauch und Griff	Tube and handle	7,30-
8 + 24	401/11	Lancia in plastica	Lanza de plástico	Kunststoff-Sprühlanze	Plastic lance	4,80-
8 + 10 + 23 + 24	401/12	Lancia in plastica con tubo, impugnatura e ugello	Lanza de plástico con tubo, impugnatura y boquilla	Kunststoff-Sprühlanze mit Schlauch, Griff und Düse	Plastic lance with tube, handle and nozzle	11,40-
24	401/13	Ugello regolabile getto diretto o nebulizzatore	Boquilla ajustable chorro directo o nebulizador	Regulierbare Düse mit Stechstrahl- und Sprühnebelfunktion	Adjustable nozzle direct jet or nebulizer	5,40-
26	237/17	Misurino dosatore graduato	Vaso medidor graduado	Messbecher mit Maßanzeige	Graduated measuring cup	0,70-

#	Art.	IT	ES	DE	EN	€
1	242/1	Serbatoio 15 L	Tanque 15 L	Tank 15 L	Tank 15 L	35,70-
2	242/2	Base serbatoio in plastica	Base tanque de plástico	Plastik-Basis Tank	Plastic tank base	25,00-
3	242/3	Coperchio circuito, viti e guarnizioni	Tapa circuito, tornillos y juntas	Deckel Sicherung, Schrauben und Dichtungen	Circuit cap, screws and seals	2,10-
4	242/4	Raccordo tubo lancia	Conector tubo lanza	Verbindung für Schlauch und Lanze	Lance-tube connector	1,50-
5	242/6	Tubo mandata motore e fascette in metallo	Tubo entrada motor y abrazaderas de metal	Motor-Verbindungsschlauch mit Metallschellen	Engine's delivery tube and metal clamps	4,20-
6	242/7	Kit guarnizioni	Kit juntas	Set Dichtungen	Seals kit	30,70-
7	242/8	Tappo e filtro	Tapón y filtro	Deckel und Filter	Cap and filter	5,00-
8	242/11	Tubo di mandata, raccordi e fascette	Tubo de entrada, conectores y abrazaderas	Verbindungsschlauch	Delivery tube, connectors and clamps	8,00-
9	247/14	Potenziometro	Potenciómetro	Druckregler	Potentiometer	18,70-
10	242/15	Fusibile	Fusible	Sicherung	Fuse	2,60-
11	252/35	Pompa di ricambio	Bomba de recambio	Ersatzpumpe	Spare pump	66,60-
12	252/40	Filtro	Filtro	Filter	Filter	2,90-
13	B-257	Batteria Li-Ion	Batería Li-Ion	Li-Ion Batterie	Li-Ion battery	104,00-
14	251/64	Cinghia	Correa	Tragegurt	Shoulder strap	10,70-
15	251/46	Connessione alimentatore	Conexión fuente de alimentación	Ladeanschluss	Charging connection	4,50-
16	257/30	Voltmetro	Indicador de carga	Voltmeter	Voltmeter	6,40-
17	C-252	Caricabatteria	Cargador	Aufladegerät	Battery charger	49,50-
18	242/29	Lancia in fibra di vetro con impugnatura	Lanza de fibra de vidrio con impugnatura	Fiberglas-Sprühlanze mit Griff	Fiberglass lance with handle	14,10-
19	242/30	Impugnatura	Empuñadura	Griff	Handle	6,60-
20	242/31	Regolatore di flusso	Regulador de flujo	Wasserfluss-regulator	Flow regulator	5,50-

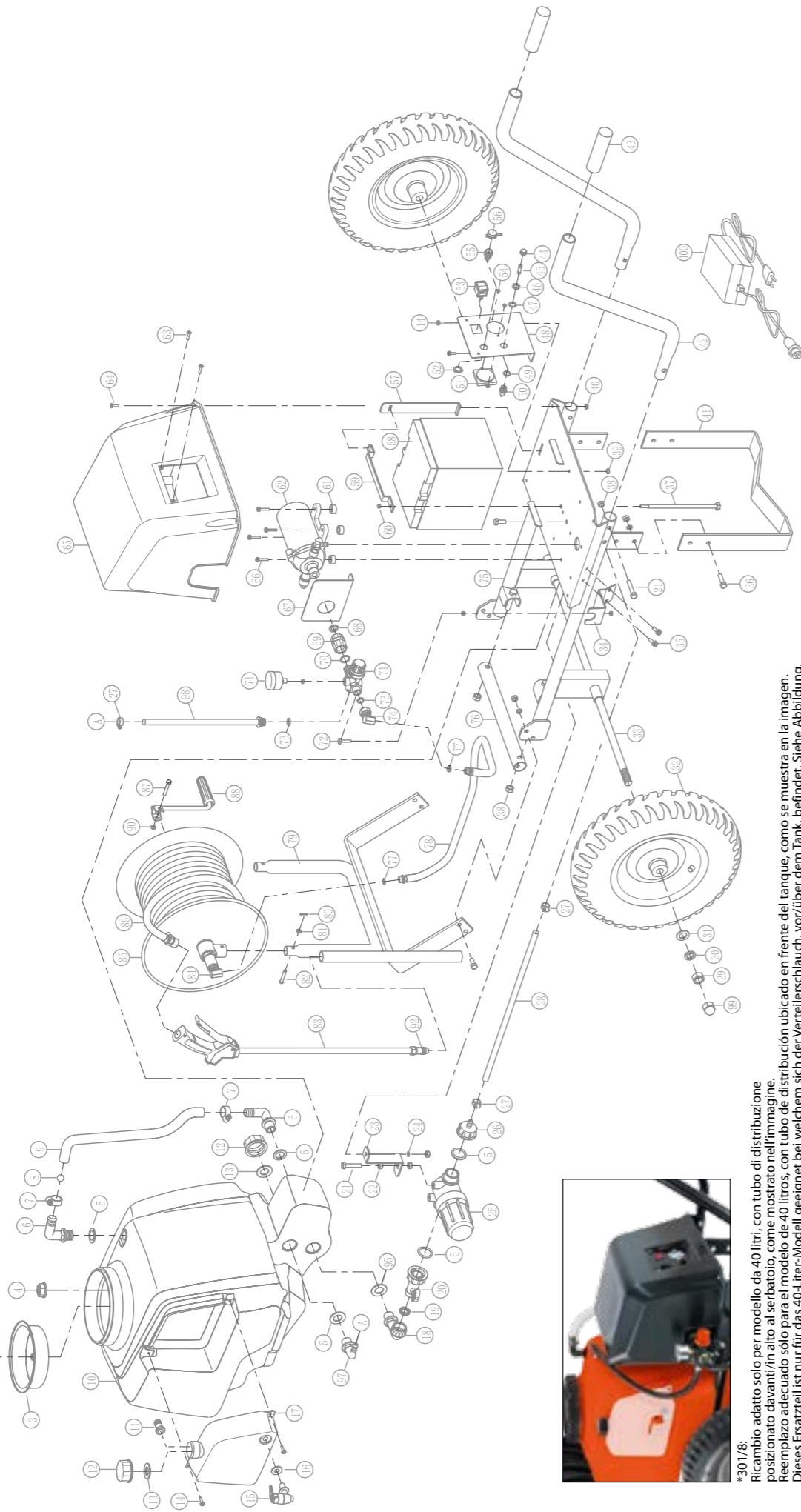

*301/8:
 Ricambio adatto solo per modello da 40 litri, con tubo di distribuzione
 posizionato davanti/in alto al serbatoio, come mostrato nell'immagine.
 Reemplazo adecuado solo para el modelo de 40 litros, con tubo de distribución
 ubicado en frente del tanque, como se muestra en la imagen.
 Dieses Ersatzteil ist nur für das 40-Liter-Modell geeignet bei welchem sich der Verteilerschlauch vor/über dem Tank befindet. Siehe Abbildung.
 Spare part only suitable for 40 liters model, with distribution tube on the upper-front side of the tank, as shown in the picture.



- ① Ricambi
- Ⓔ Recambios
- Ⓓ Ersatzteile
- Ⓖ Spare parts

Art. 301, 302



#	Art.	IT	ES	DE	EN	€
29x2 + 30x2 + 31x2 + 32x2 + 99x2	301/1	Ruote	Ruedas	Räder	Wheels	59,60-
1 + 2 + 3 + 12x2 + 13x2	301/2	Set tappi e filtro	Set tapones y filtro	Kappen und Filter Set	Caps and filter set	6,05-
33 + 38x6 + 39x4 + 76 + 75 + 48 + 14x4 + 36x4 + 41 + 67	301/3	Telaio	Chasis	Rahmen	Chassis	32,05-
85 + 87 + 88 + 82 + 81 + 80 + 79 + 90	301/4	Avvolgigtubo	Portamanguera	Schlauchaufroller	Hose reel	63,10-
86	301/5	Tubo di irrigazione 30 m	Tubo de irrigación 30 m	Bewässerungsschlauch 30 m	Irrigation tube 30 m	64,50-
83 + 92	301/6	Lancia in alluminio con impugnatura	Lanza de aluminio con empuñadura	Aluminium-Sprühlanze mit Griff	Aluminium lance with handle	20,90-
65 + 64x4 + 63x2 + 40x4	301/7	Coperchio batteria	Tapa batería	Batterieabdeckung	Battery cover	11,65-
89 + 27x5 + 78 + 28	301/8*	Set tubi di distribuzione	Set tubos de distribución	Verteilerrohr Set	Distribution tubes set	7,30-
97 + 27x5 + 98 + 78 + 28 + 77x2	301/26	Set tubi di distribuzione	Set tubos de distribución	Verteilerrohr Set	Distribution tubes set	10,30-
42x2 + 43x2 + 21x4 + 38x4	301/9	Manici	Mangos	Griffe	Handles	17,50-
58	301/10	Batteria	Batería	Batterie	Battery	239,00-
5x3 + 18 + 19 + 20 + 25 + 26 + 24 + 22 + 21 + 23	301/11	Filtro	Filtro	Filter	Filter	20,90-
72 + 74 + 73 + 71 + 70 + 69 + 68 + 34 + 35x2	301/12	Regolatore di pressione	Regulador de presión	Druckregler	Pressure regulator	27,30-
66x4 + 62 + 61x4	301/13	Motore	Motor	Motor	Engine	99,10-
4 + 5x3 + 6x3 + 7x2 + 8 + 9	301/14	Tubo indicatore del livello di riempimento	Tubo indicador del nivel de llenado	Füllstandsrohr	Water-level tube	7,10-
53	301/15	Interruttore	Interruptor	Schalter	Power button	4,45-
51 + 54x2	301/16	Voltmetro	Voltmetro	Voltmeter	Voltmeter	5,50-
52 + 55 + 56	301/17	Presa di carica	Puerto de carga	Ladebuchse	Charging port	2,95-
44 + 45 + 46 + 47 + 49 + 50	301/18	Fusibile	Fusible	Sicherung	Fuse	3,90-
11 + 17 + 16 + 15 + 14x2	301/19	Serbatoio piccolo 1,8 L	Tanque pequeño 1,8 L	Tank klein 1,8 L	Small tank 1,8 L	7,45-
10	301/20	Serbatoio 40 L (Art. 301)	Tanque 40 L (Art. 301)	Tank 40 L (Art. 301)	Tank 40 L (Art. 301)	45,40-
60 + 59 + 57 + 37	301/21	Fissaggio per batteria	Fijación para batería	Batteriebefestigung	Battery fixing system	7,10-
100	301/22	Caricabatteria	Cargador	Ladegerät	Battery charger	40,75-
92	301/23	Ugello regolabile getto diretto o nebulizzazione	Boquilla ajustable chorro directo o nebulización	Regulierbare Düse mit Nebel- und Strohstrahlfunktion	Adjustable nozzle direct jet or nebulization	2,70-
36x4 + 21x6 + 38x6 + 29x2 + 30x2 + 31x2 + 39x2 + 66x4 + 63x2 + 72 + 14x2 + 22x6 + 24 + 90 + 87 + 82x2 + 81x2 + 80x2 + 34 + 35x2 + 64x4 + 40x4	301/24	Kit viti e bulloni	Kit tornillos y bulones	Schrauben und Bolzen Kit	Screws and bolts kit	10,40-
2 + 13 + 16 + 5x6 + 19 + 73 + 70 + 77 + 68	301/25	Kit guarnizioni	Kit juntas	Dichtungen Kit	Washers set	2,70-
84	301/27	Raccordo a 90° con snodo per tubo di irrigazione	Conector de 90° con junta para manguera de riego	90°-Winkelkupplung für Bewässerungsleitung	90° connector with joint for irrigation pipe	9,75-
10	302/1	Serbatoio 60 L (Art. 302)	Tanque 60 L (Art. 302)	Tank 60 L (Art. 302)	Tank 60 L (Art. 302)	69,80-



Serbatoio 80 L
Tanque 80 L
Tank 80 L
Art. 303/1

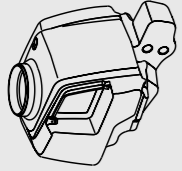

Serbatoio 100 L
Tanque 100 L
Tank 100 L
Art. 304/1

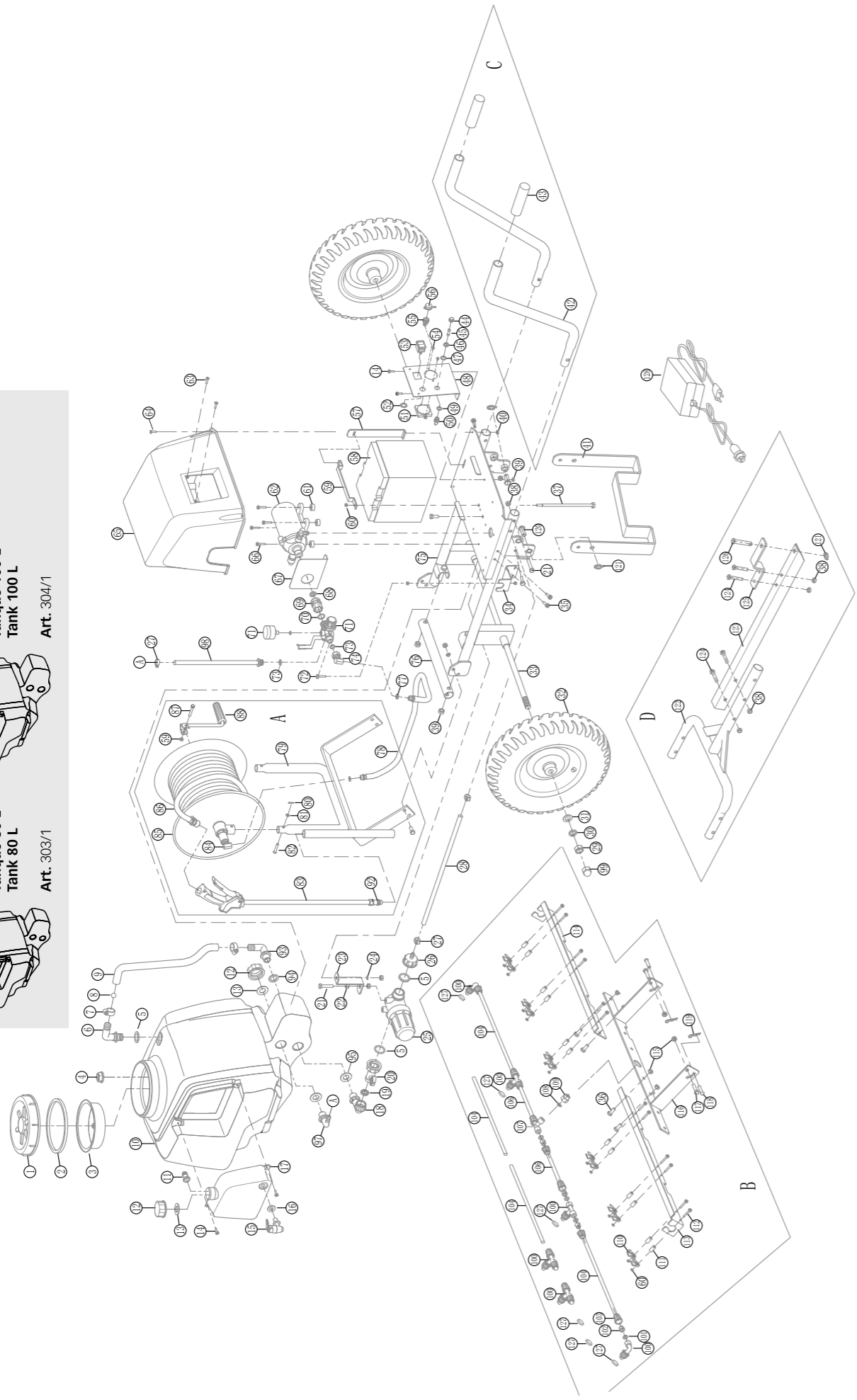

- ① Ricambi
② Recambios
③ Ersatzteile
④ Spare parts

Art. 303, 304



#	Art.	IT	ES	DE	EN	€
29x2 + 30x2 + 31x2 + 32x2 + 99x2	301/1	Ruote	Ruedas	Räder	Wheels	59,60-
1 + 2 + 3 + 12x2 + 13x2	301/2	Set tappi e filtro	Set tapones y filtro	Kappen und Filter Set	Caps and filter set	6,05-
83 + 92	301/6	Lancia in alluminio con impugnatura	Lanza de aluminio con empuñadura	Aluminium-Sprühlanze mit Griff	Aluminium lance with handle	20,90-
65 + 64x4 + 63x2 + 40x4	301/7	Coperchio batteria	Tapa batería	Batterieabdeckung	Battery cover	11,65-
42x2 + 43x2 + 21x4 + 38x4	301/9	Manici	Mangos	Griffe	Handles	17,50-
58	301/10	Batería	Batería	Batterie	Battery	239,00-
5x3 + 18 + 19 + 20 + 25 + 26 + 24 + 23 + 22 + 21	301/11	Filtro	Filtro	Filter	Filter	20,90-
66x4 + 62 + 61x4	301/13	Motore	Motor	Motor	Engine	99,10-
53	301/15	Interruttore	Interruptor	Schalter	Power button	4,45-
51 + 54x4	301/16	Voltmetro	Voltmetro	Voltmeter	Voltmeter	5,50-
52 + 55 + 56	301/17	Presa di carica	Puerto de carga	Ladebuchse	Charging port	2,95-
44 + 45 + 46 + 47 + 49 + 50	301/18	Fusibile	Fusible	Sicherung	Fuse	3,90-
11 + 17 + 16 + 15 + 14x2	301/19	Serbatoio piccolo 1,8 L	Tanque pequeño 1,8 L	Tank klein 1,8 L	Small tank 1,8 L	7,45-
60 + 59 + 57 + 37	301/21	Fissaggio per batteria	Fijación para batería	Batteriebefestigung	Battery fixing system	7,10-
128	301/22	Caricabatteria	Cargador	Ladegerät	Battery charger	40,75-
92	301/23	Ugello	Boquilla	Düse	Nozzle	2,70-
2 + 13 + 16 + 5x6 + 19 + 73 + 70 + 77 + 68	301/25	Kit guarnizioni	Kit juntas	Dichtungen Kit	Washers set	2,70-
10	303/1	Serbatoio 80 L (Art. 303)	Tanque 80 L (Art. 303)	Tank 80 L (Art. 303)	Tank 80 L (Art. 303)	102,50-
33 + 38x6 + 39x4 + 75 + 76 + 48 + 14x4 + 121x2 + 41 + 21x2 + 67	303/2	Telaio	Chasis	Rahmen	Chassis	52,10-
85 + 87 + 59 + 88 + 82x2 + 81x2 + 80x2 + 79	303/4	Avvolgitubo	Portamanguera	Schlauchaufroller	Hose reel	63,10-
86	303/4	Tubo de irrigazione 50 m	Tubo de irrigación 50 m	Bewässerungsschlauch 50 m	Irrigation tube 50 m	120,00-
98 + 27x5 + 78 + 28 + 77x2	303/5	Set tubi di distribuzione	Set tubos de distribución	Verteilerrohr Set	Distribution tubes set	10,00-
72 + 74 + 73 + 71 + 70 + 69 + 68 + 34 + 35x2	303/6	Regolatore di pressione	Regulador de presión	Druckregler	Pressure regulator	26,70-
4 + 5x3 + 6x3 + 7x2 + 8 + 9	303/7	Tubo indicatore del livello di riempimento	Tubo indicador del nivel de llenado	Füllstandsrohr	Water-level tube	6,55-
36x4 + 21x6 + 38x6 + 29x2 + 30x2 + 31x2 + 39x2 + 66x4 + 63x2 + 72 + 14x2 + 22x6 + 24 + 59 + 87 + 82x2 + 81x2 + 80x2 + 34 + 35x2 + 64x4 + 40x4	303/8	Kit viti e bulloni	Kit tornillos y bulones	Kit Schrauben und Bolzen	Screws and bolts kit	13,80-
121 + 122 + 124x4 + 38x4 + 123 + 125 + 126	303/9	Gancio traino	Gancho de remolque	Schlepphaken	Swinging drawbar	37,15-
84	301/27	Raccordo a 90° con snodo per tubo di irrigazione	Conector de 90° con junta para manguera de riego	90°-Winkelkupplung für Bewässerungsleitung	90° connector with joint for irrigation pipe	9,75-
10	304/1	Serbatoio 100 L (Art. 304)	Tanque 100 L (Art. 304)	Tank 100 L (Art. 304)	Tank 100 L (Art. 304)	126,00-
100x6 + 101x10 + 102x10 + 103x12 + 104x4 + 106x2 + 107 + 108 + 109 + 110x6 + 60x12 + 111x12 + 112x12 + 36x4 + 115x6 + 113 + 114 + 116 + 117x2 + 118x2 + 119x2	305	Barra d'irrigazione per tappeti erbosi	Barra de irrigación para céspedes	Sprühlanze für Grünflächen	Irrigation bar for grass	80,20-
100x6 + 101x10 + 102x10 + 103x12 + 104x4 + 106x2 + 107 + 110x6 + 60x12 + 111x12 + 112x12	305/1	Kit aste e ugelli	Kit varas y boquillas	Röhren und Düsen Kit	Rod and nozzle kit	16,00-
108 + 109	305/2	Raccordo tubo barra	Conector tubo barra	Verbindung für Schlauch und Lanze	Tube-bar connector	5,00-
100x6 + 127x6	305/3	Kit ugelli e dischetti di chiusura	Kit de boquillas y discos de cierre.	Düsen und Verschlusskappen Kit	Nozzles and sealing disks kit	0,90-
60x12 + 112x12 + 36x4 + 115x6 + 117x2 + 118x2 + 119x2	305/4	Kit viti e bulloni	Kit tornillos y bulones	Schrauben und Bolzen Kit	Screws and bolts kit	5,00-

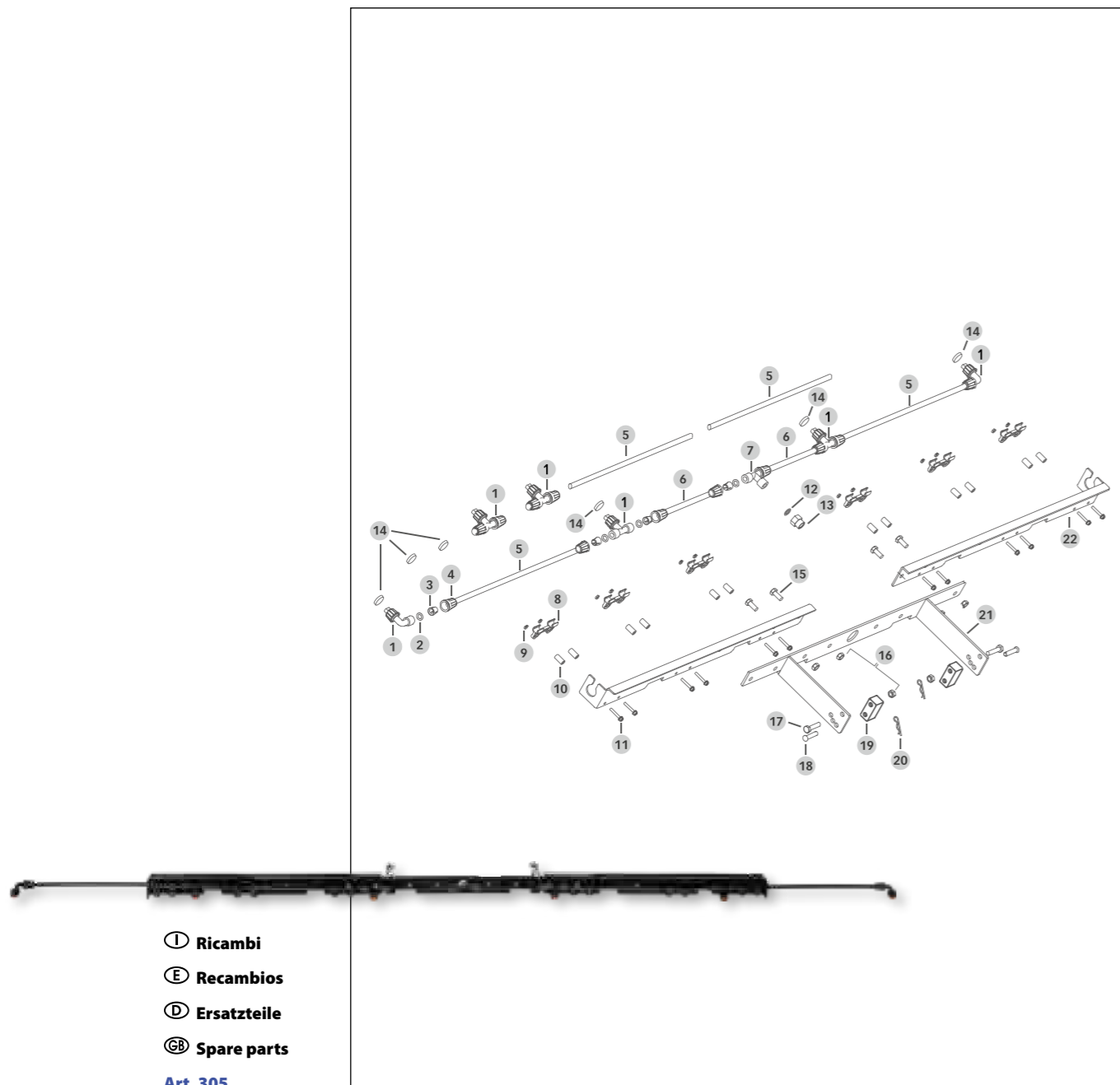

- ① Ricambi
- Ⓔ Recambios
- Ⓓ Ersatzteile
- Ⓒ Spare parts

Art. 305

#	Art.	IT	ES	DE	EN	€
1x6 + 2x10 + 3x10 + 4x12 + 5x4 + 6x2 + 7 + 8x6 + 9x12 + 10x12 + 11x12	305/1	Kit aste e 6 ugelli a ventaglio	Kit varas y 6 boquillas en forma de abanico	Düsen- und Röhrenset	Rods and 6 fan-nozzles kit	16,00-
12 + 13	305/2	Raccordo tubo barra	Connector tubo barra	Verbindung für Schlauch und Lanze	Tube-bar connector	5,00-
1x6 + 14x6	305/3	Kit ugelli a ventaglio e dischetti di chiusura	Kit boquillas en forma de abanico y discos de cierre	Düsen- und Verschlusskappenset	Fan-nozzles and sealing disks kit	0,90-
9x12 + 11x12 + 15x4 + 16x6 + 17x2 + 18x2 + 19x2 + 20x2	305/4	Kit viti e bulloni	Kit tornillos y bulones	Schrauben und Bolzen Kit	Screws and bolts kit	5,00-

Stocker
Forbici ad asta lunga
Tijeras de mango largo
 Langarm-Scheren
 Long handled pruning shears



- ① Ricambi
- Ⓔ Recambios
- Ⓓ Ersatzteile
- Ⓒ Spare parts

Art. 606, 607

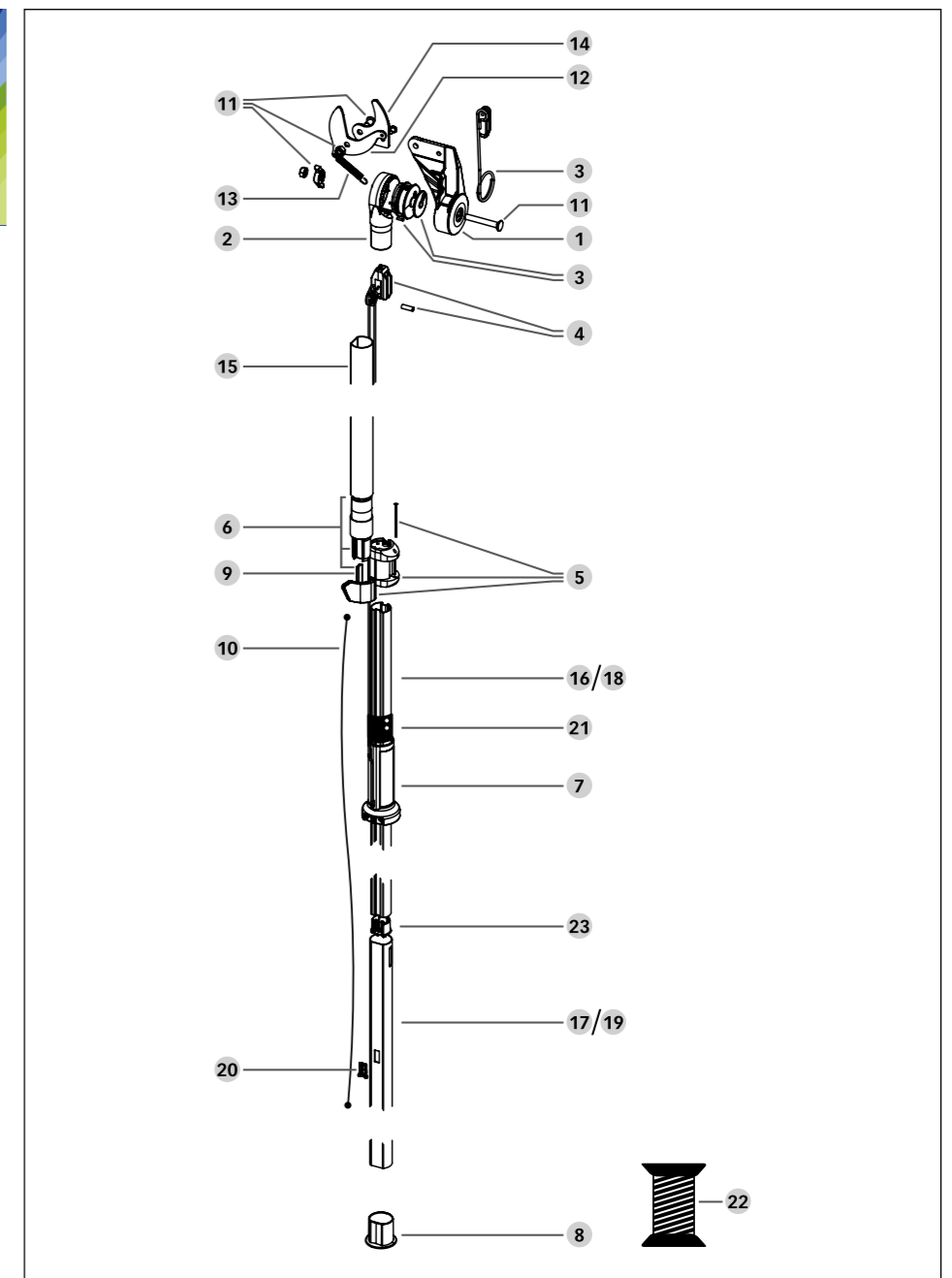

#	Art.	IT	ES	DE	EN	€
1	606/1	Supporto controlama	Soporte contra hoja	Unterlage für Gegenklinge	Anvil support	12,45-
2	606/2	Protezione per carrucola	Protección para polea	Rollengehäuse	Pulley cover	10,20-
3	606/3	Carrucola con corda e attacco lama	Polea con cuerda y conexión hoja	Rolle mit Seil und Klingenbefestigung	Pulley with cord and blade attachment	13,40-
4	606/5	Carrello	Guía	Führung	Slide bar	4,65-
5	606/6	Kit blocco completo telescopico	Kit bloqueo completo telescópico	Kit Teleskopverschluss komplett	Telescopic locking kit	8,15-
6	606/7	Collegamento tubo	Conexión tubo	Verbindungsrohr	Tube connection	4,80-
7	606/8	Impugnatura	Empuñadura	Griff	Handle	5,70-
8	606/9	Tappo	Tapón	Verschluss	Cap	4,20-
9	606/10	Blocco di chiusura	Bloqueo de cierre	Verschluss	Lock	2,30-
10	606/11	Corda lunga	Cuerda larga	Zugband lang	Long cord	12,80-
11	606/12	Kit bullone centrale e bullone lama	Kit bulón central y bulón hoja	Kit Zentral - und Klingenbolzen	Kit central bolt and blade bolt	5,95-
12	606/13	Lama per forbice	Hoja para tijera	Klinge für Schere	Blade for shears	23,40-
13	606/14	Molla per forbice	Muelle para tijera	Feder für Schere	Spring for shears	3,90-
14	606/15	Controlama per forbice	Contra hoja para tijera	Gegenklinge für Schere	Anvil for shears	13,05-
15	606/16	Tubo superiore	Tubo superior	Griffrohr oben	Upper tube	13,80-
16	606/17	Tubo interno	Tubo interno	Innenrohr	Internal tube	22,35-
17	606/18	Tubo esterno	Tubo esterno	Außenrohr	External tube	21,95-
18	607/1	Tubo interno	Tubo interno	Innenrohr	Internal tube	31,20-
19	607/2	Tubo esterno	Tubo esterno	Außenrohr	External tube	27,95-
20	606/20	Passacorda	Pasacuerda	Seildurchlauf	Rope passage	1,35-
21	606/21	Battuta per maniglia	Parada para manija	Anschlag für Griff	Stopper for handle	5,50-
22	606/19	Bobina corda 102 m	Bobina cuerda 102 cm	Spule mit Zugband 102 m	Replacement cord spool 102 m	105,00-
23	606/23	Guida corda interna	Guía interna para la cuerda	Interne Seilführung	Internal rope guide	5,30-



① Ricambi
 ② Recambios
 ③ Ersatzteile
 ④ Spare parts
Art. 608, 609

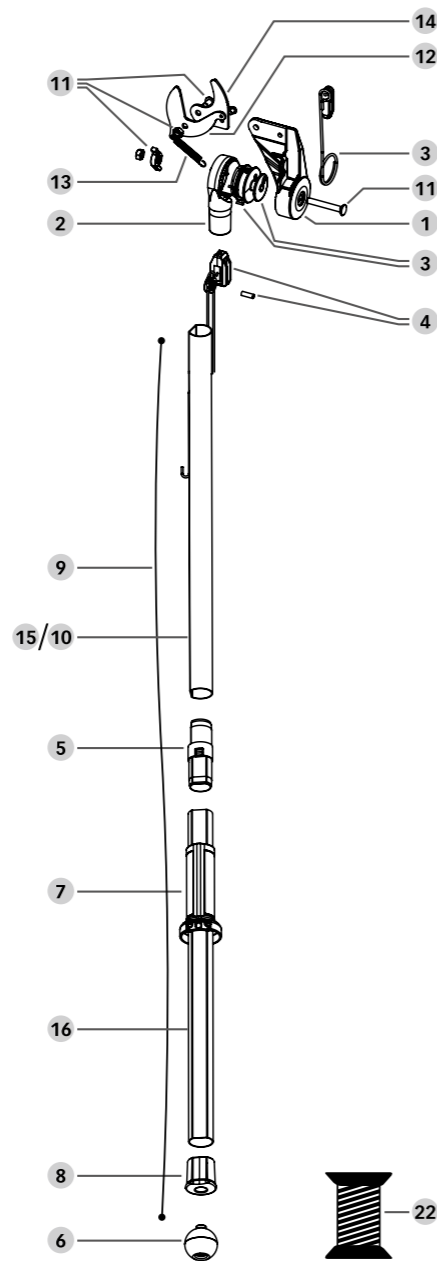

#	Art.	IT	ES	DE	EN	€
1	606/1	Supporto controlama	Soporte contra hoja	Unterlage für Gegenklinge	Anvil support	12,45-
2	606/2	Protezione per carrucola	Protección para polea	Rollengehäuse	Pulley cover	10,20-
3	606/3	Carrucola con corda e attacco lama	Polea con cuerda y conexión hoja	Rolle mit Seil und Klängenbefestigung	Pulley with cord and blade attachment	13,40-
4	606/5	Carrello	Guía	Führung	Slide bar	4,65-
5	608/1	Collegamento tubo	Conexión tubo	Rohranschluss	Tube connection	4,75-
6	608/2	Sfera	Esfera	Kugel	Sphere	4,20-
7	606/8	Impugnatura	Empuñadura	Griff	Handle	5,70-
8	606/9	Tappo	Tapón	Verschluss	Cap	4,20-
9	608/3	Corda lunga	Cuerda larga	Langes Seil	Long cord	12,35-
10	609/1	Tubo superiore manico	Tubo superior mango	Griffrohr oben	Upper tube	25,10-
11	606/12	Kit bullone centrale e bullone lama	Kit bulón central y bulón hoja	Kit Zentral - und Klängenbolzen	Kit central bolt and blade bolt	5,95-
12	606/13	Lama per forbice	Hoja para tijera	Klinge für Schere	Blade for shears	23,40-
13	606/14	Molla per forbice	Muelle para tijera	Feder für Schere	Spring for shears	3,90-
14	606/15	Controlama per forbice	Contra hoja para tijera	Gegenklinge für Schere	Anvil for shears	13,05-
15	608/4	Tubo superiore manico	Tubo superior mango	Griffrohr oben	Upper tube	21,95-
16	608/5	Tubo inferiore manico	Tubo inferior mango	Griffrohr unten	Lower tube	24,00-
22	606/19	Bobina corda 102 m	Bobina cuerda 102 cm	Spule mit Zugband 102 m	Replacement cord spool 102 m	105,00-



① Ricambi
 ② Recambios
 ③ Ersatzteile
 ④ Spare parts
Art. 565, 566, 567

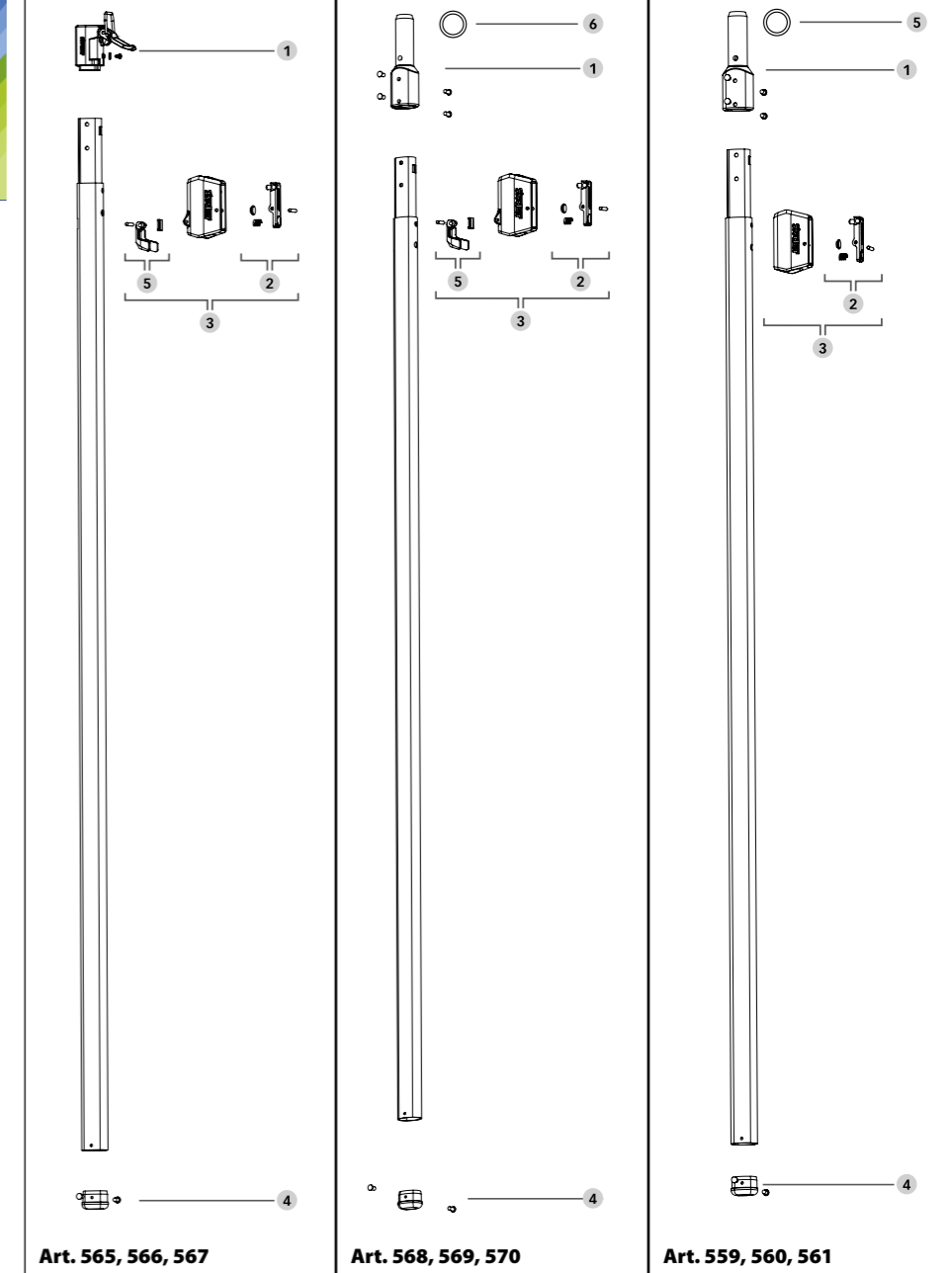

#	Art.	IT	ES	DE	EN	€
1	565/1	Adattatore Combisystem per manici telescopici	Adaptador Combisystem para mangos telescópicos	Combisystem Adapter für Teleskopstiele	Combisystem connection for telescopic handles	8,90-
2	559/2	Pulsante di bloccaggio	Botón de bloqueo	Blockierknopf	Locking button	3,00-
3	565/3	Blocco Profi	Bloqueo Profi	Blockiersystem Profi	Profi stopper	9,50-
4	559/4	Tappo terminale	Tapón terminal	Endstopfen	End cap	3,00-
5	565/2	Leva di bloccaggio Profi	Palanca de bloqueo Profi	Blockierknopf Profi	Locking clip Profi	3,00-

Art. 568, 569, 570

#	Art.	IT	ES	DE	EN	€
1	559/1	Adattatore universale per manici telescopici	Adaptador universal para mangos telescópicos	Universeller Adapter für Teleskopstiel	Universal connection for telescopic handles	7,20-
2	559/2	Pulsante di bloccaggio	Botón de bloqueo	Blockierknopf	Locking button	3,00-
3	565/3	Blocco Profi	Bloqueo Profi	Blockiersystem Profi	Profi stopper	9,50-
4	559/4	Tappo terminale	Tapón terminal	Endstopfen	End cap	3,00-
5	565/2	Leva di bloccaggio Profi	Palanca de bloqueo Profi	Blockierknopf Profi	Locking clip Profi	3,00-
6	559/5	O-Ring per adattatore universale	O-Ring para adaptador universal	O-Ring für universellen Adapter	O-Ring for universal adapter	1,20-

Art. 559, 560, 561

#	Art.	IT	ES	DE	EN	€
1	559/1	Adattatore universale per manici telescopici	Adaptador universal para mangos telescópicos	Universeller Adapter für Teleskopstiel	Universal connection for telescopic handles	7,20-
2	559/2	Pulsante di bloccaggio	Botón de bloqueo	Blockierknopf	Locking button	3,00-
3	559/3	Blocco	Bloqueo	Blockiersystem Profi	Stopper	5,60-
4	559/4	Tappo terminale	Tapón terminal	Endstopfen	End cap	3,00-
5	559/5	O-Ring per adattatore universale	O-Ring para adaptador universal	O-Ring für universellen Adapter	O-Ring for universal adapter	1,20-



Art. 511
Art. 518
Art. 523

- ① Ricambi
- ⓔ Recambios
- Ⓓ Ersatzteile
- Ⓞ Spare parts

Art. 511

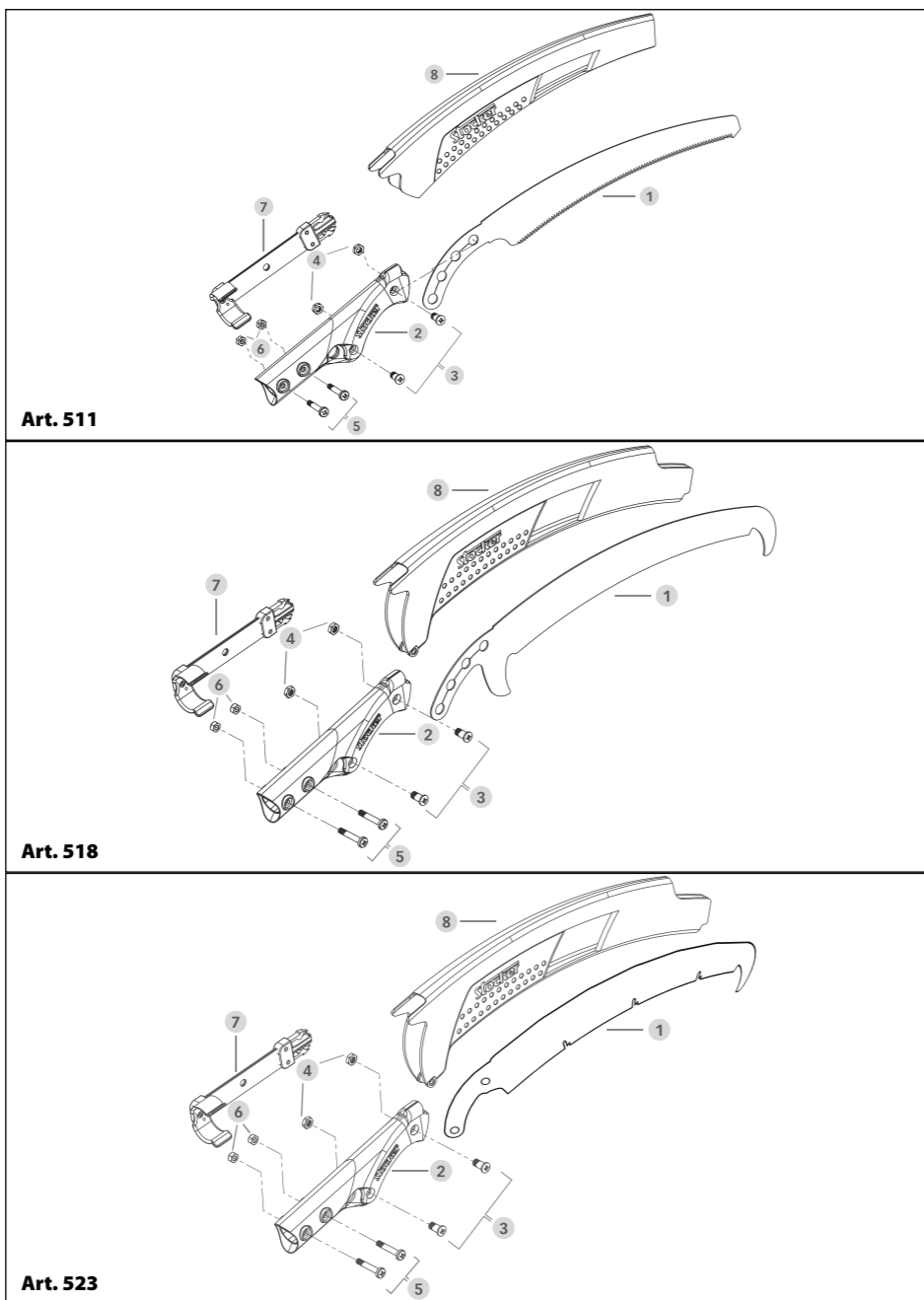

Art. 511

Art. 518

Art. 523

#	Art.	IT	ES	DE	EN	€
7	511/1	Clip per fodero	Clip para funda	Clip für Hülle	Clip for sheath	6,20-
2+3+4+5+6	511/2	Corpo del seghetto	Cuerpo del serrucho	Sägenkörper	Body of the saw	10,40-
3+4+5+6	511/3	Kit dadi e bulloni	Kit tuercas y bulones	Kit Mutter und Bolzen	Nuts and bolts kit	13,05-
1	R-14533	Lama per seghetto	Hoja para serrucho	Sägeblatt für Handsäge	Blade for saw	27,45-
7+8	F-14527	Fodero per seghetto	Funda para serrucho	Hülle für Handsäge	Sheath for saw	10,00-

Art. 518

#	Art.	IT	ES	DE	EN	€
7	511/1	Clip per fodero	Clip para funda	Clip für Hülle	Clip for sheath	6,20-
2+3+4+5+6	518/2	Corpo del seghetto	Cuerpo del serrucho	Sägenkörper	Body of the saw	10,40-
3+4+5+6	511/3	Kit dadi e bulloni	Kit tuercas y bulones	Kit Mutter und Bolzen	Nuts and bolts kit	13,05-
1	518/1	Lama per seghetto	Hoja para serrucho	Sägeblatt für Handsäge	Blade for saw	30,30-
7+8	518/3	Fodero per seghetto	Funda para serrucho	Hülle für Handsäge	Sheath for saw	12,30-

Art. 523

#	Art.	IT	ES	DE	EN	€
7	511/1	Clip per fodero	Clip para funda	Clip für Hülle	Clip for sheath	6,20-
2+3+4+5+6	518/2	Corpo del seghetto	Cuerpo del serrucho	Sägenkörper	Body of the saw	10,40-
3+4+5+6	511/3	Kit dadi e bulloni	Kit tuercas y bulones	Kit Mutter und Bolzen	Nuts and bolts kit	13,05-
1	523/1	Lama per seghetto	Hoja para serrucho	Sägeblatt für Handsäge	Blade for saw	29,55-
7+8	518/3	Fodero per seghetto	Funda para serrucho	Hülle für Handsäge	Sheath for saw	12,30-

stocker
 Pompe manuali
 Bombas manuales
 Manuelle Druckpumpen
 Manual sprayers



- ① Ricambi
- ⓔ Recambios
- Ⓓ Ersatzteile
- Ⓞ Spare parts

Art. 243

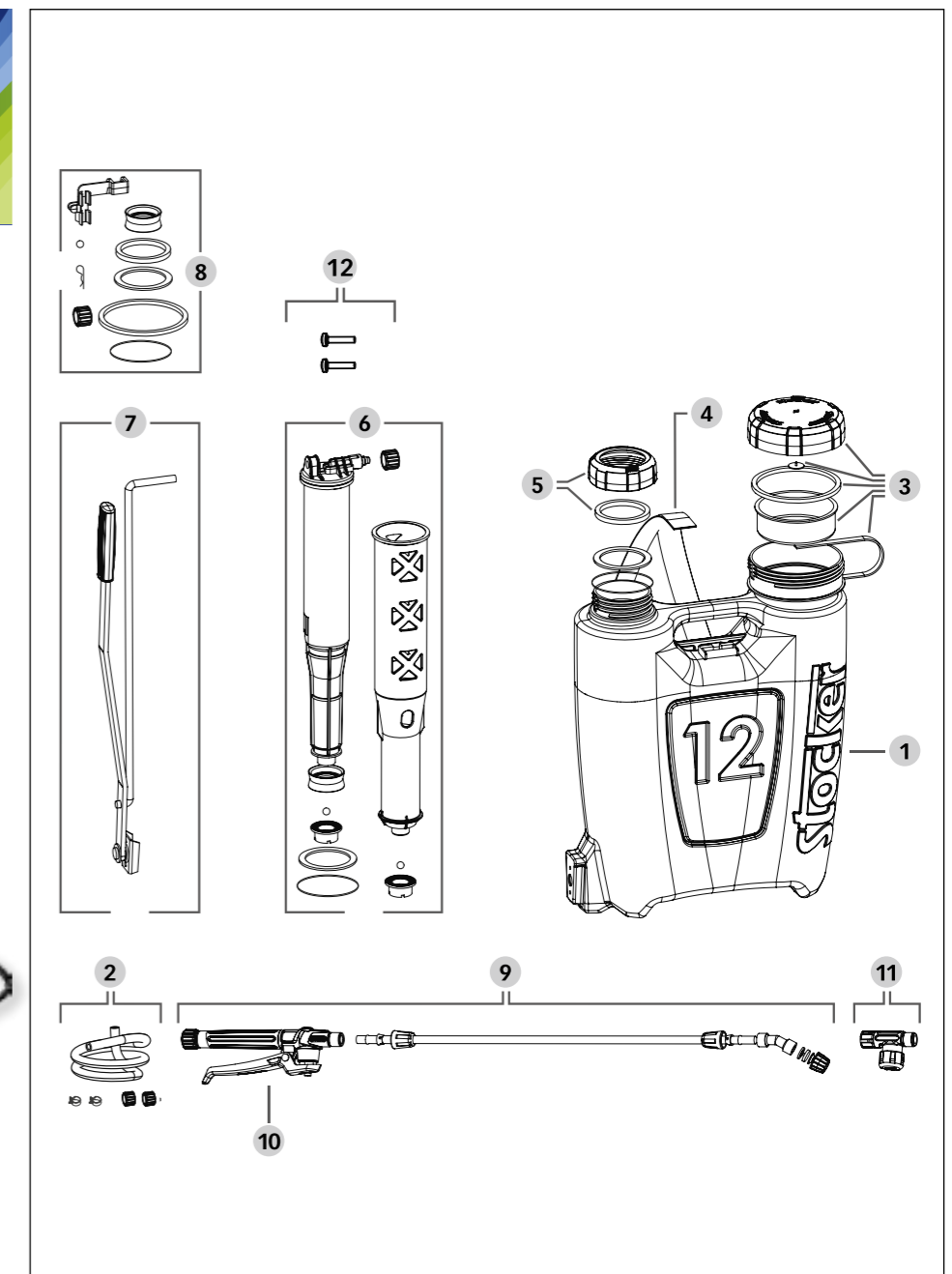

#	Art.	IT	ES	DE	EN	€
1	243/1	Serbatoio 12 L	Tanque 12 L	Tank für 12 L	Tank 12 L	33,40-
2	242/11	Tubo di mandata, raccordi e fascette	Tubo de entrada, conectores y abrazaderas	Verbindungsschlauch	Delivery tube, connectors and clamps	8,00-
3	242/8	Tappo e filtro	Tapón y filtro	Deckel und Filter	Cap and filter	5,00-
4	R-253	Cinghia	Correa	Gurt	Straps	5,30-
5	243/21	Ghiera e guarnizione	Cápsula y junta	Gewinding und Dichtung	Ring nut and seal	1,50-
6	243/20	Pompante con guarnizione	Bombeador con junta	Pumpvorrichtung mit Dichtung	Pumper with seal	19,20-
7	M-253	Manico per pompante	Mango para bombeador	Pumphebel	Handle for pumper	9,20-
8	243/22	Set O-Ring	Set O-Rings	Set O-Ring	O-Rings set	4,60-
9	242/29	Lancia in fibra di vetro con impugnatura	Lanza de fibra de vidrio con empuñadura	Fiberglas-Sprühlanze mit Griff	Fiberglass lance with handle	14,10-
10	242/30	Impugnatura	Empuñadura	Griff	Handle	6,60-
11	242/31	Regolatore di flusso	Regulador de flujo	Wasserfluss-regulator	Flow regulator	5,50-
12	243/2	Viti di fissaggio per maniglia	Tornillos de fijación para manija	Fixierschrauben für Handgriff	Screws for fixing handle	2,20-



- ① Ricambi
- Ⓔ Recambios
- Ⓓ Ersatzteile
- Ⓒ Spare parts

Art. 248

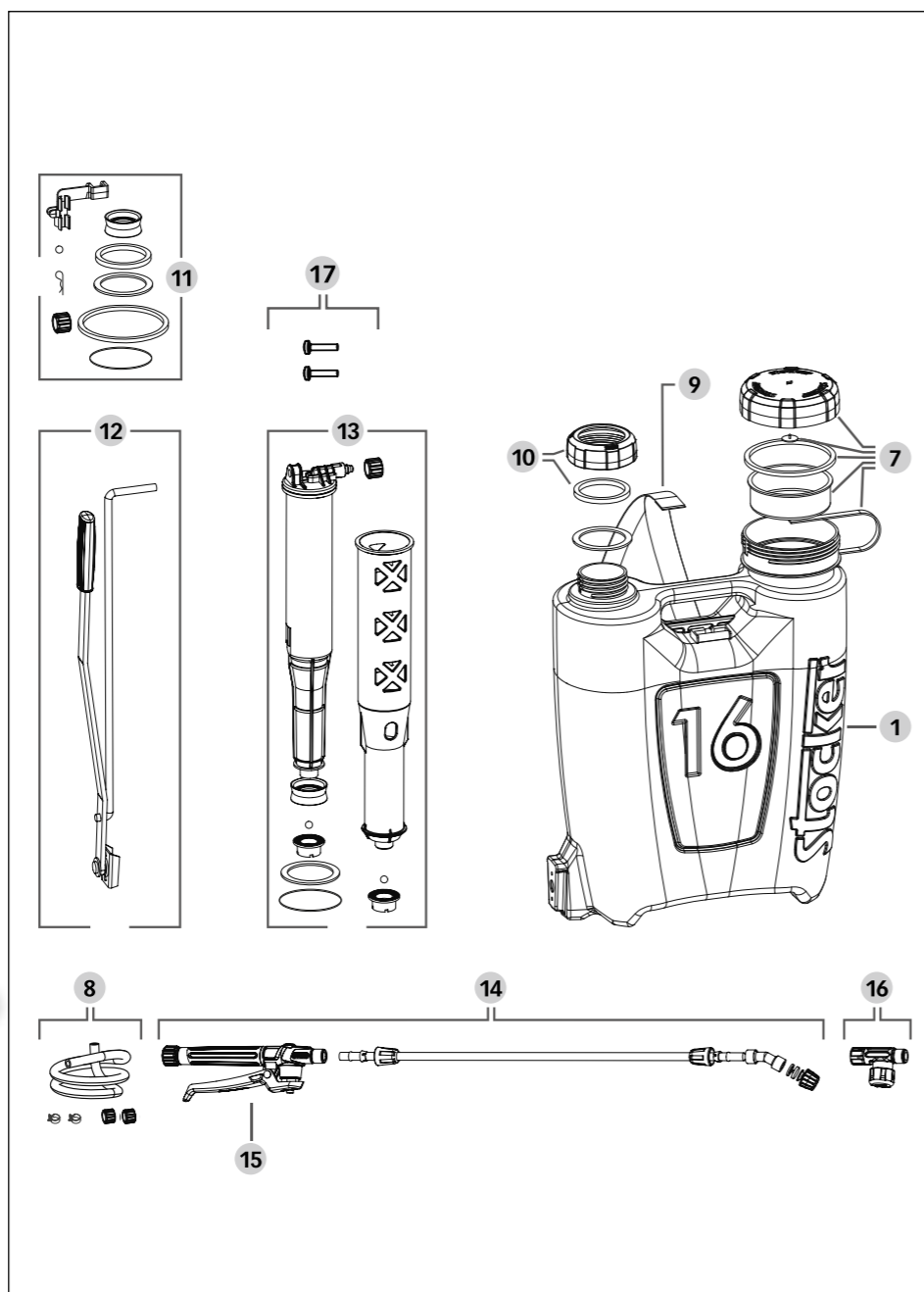

#	Art.	IT	ES	DE	EN	€
1	248/1	Serbatoio 16 L	Tanque 16 L	Tank 16 L	Tank 16 L	36,00-
7	242/8	Tappo e filtro	Tapón y filtro	Deckel und Filter	Cap and filter	5,00-
8	242/11	Tubo di mandata, raccordi e fascette	Tubo de entrada, conectores y abrazaderas	Verbindungsschlauch	Delivery tube, connectors and clamps	8,00-
9	R-253	Cinghia	Correa	Gurt	Straps	5,30-
10	243/21	Ghiera e guarnizione	Cápsula y junta	Gewinding und Dichtung	Ring nut and seal	1,50-
11	243/22	Set O-Ring	Set O-Rings	Set O-Ring	O-Rings set	4,60-
12	248/24	Manico	Mango	Griff	Handle	9,00-
13	248/25	Pompante con guarnizione	Bombedador con junta	Pumpvorrichtung mit Dichtung	Pumper with seal	22,10-
14	242/29	Lancia in fibra di vetro con impugnatura	Lanza de fibra de vidrio con empuñadura	Fiberglas-Sprühlanze mit Griff	Fiberglass lance with handle	14,10-
15	242/30	Impugnatura	Empuñadura	Griff	Handle	6,60-
16	242/31	Regolatore di flusso	Regulador de flujo	Wasserfluss-regulator	Flow regulator	5,50-
17	243/2	Viti di fissaggio per maniglia	Tornillos de fijación para manija	Fixierschrauben für Handgriff	Screws for fixing handle	2,20-



- ① Ricambi
- Ⓔ Recambios
- Ⓓ Ersatzteile
- Ⓒ Spare parts

Art. 249

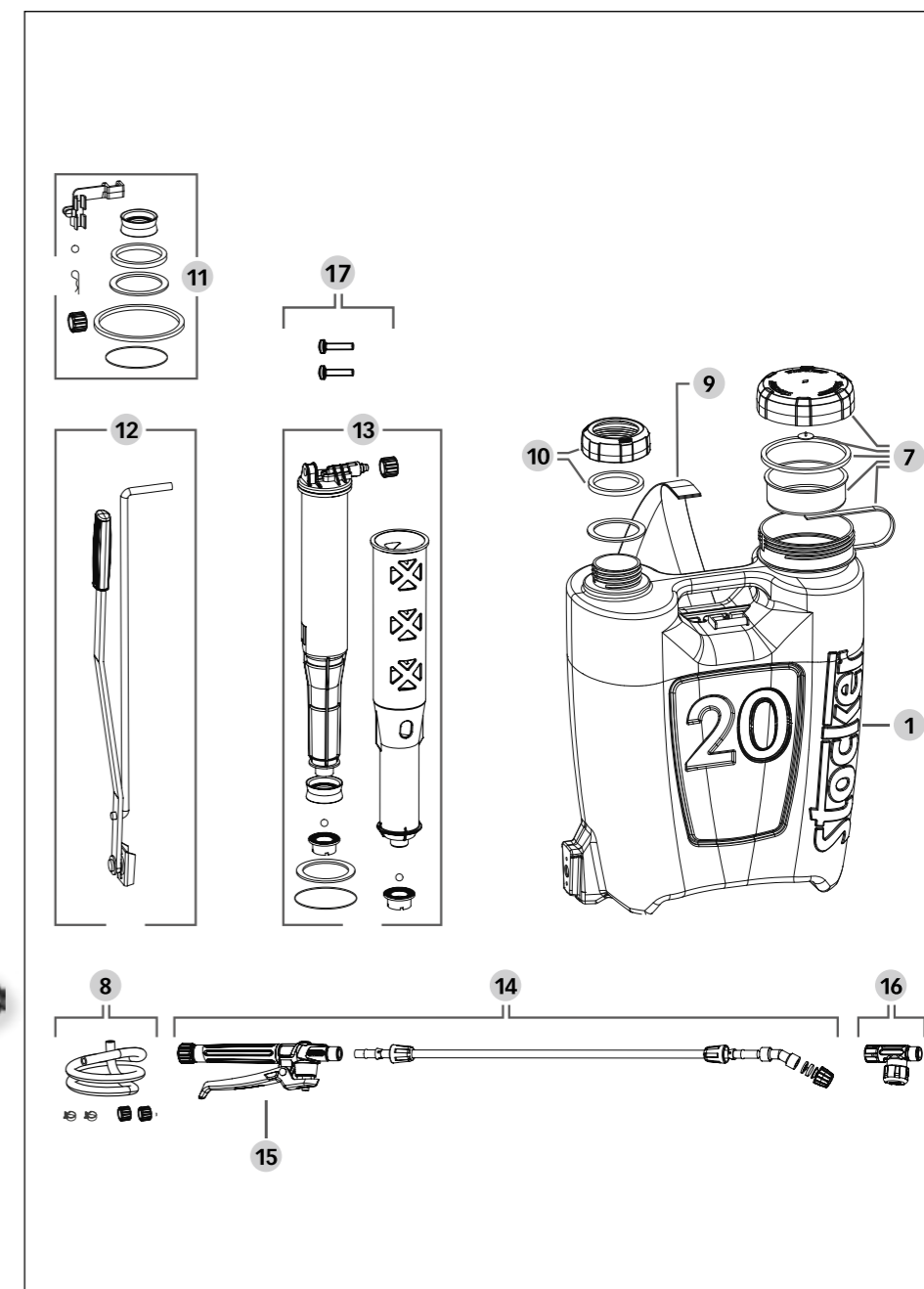

#	Art.	IT	ES	DE	EN	€
1	249/1	Serbatoio 20 L	Tanque 20 L	Tank 20 L	Tank 20 L	37,50-
7	242/8	Tappo e filtro	Tapón y filtro	Deckel und Filter	Cap and filter	5,00-
8	242/11	Tubo di mandata, raccordi e fascette	Tubo de entrada, conectores y abrazaderas	Verbindungsschlauch	Delivery tube, connectors and clamps	8,00-
9	R-253	Cinghia	Correa	Gurt	Straps	5,30-
10	243/21	Ghiera e guarnizione	Cápsula y junta	Gewinding und Dichtung	Ring nut and seal	1,50-
11	243/22	Set O-Ring	Set O-Rings	Set O-Ring	O-Rings set	4,60-
12	248/24	Manico	Mango	Griff	Handle	9,00-
13	248/25	Pompante con guarnizione	Bombedador con junta	Pumpvorrichtung mit Dichtung	Pumper with seal	22,10-
14	242/29	Lancia in fibra di vetro con impugnatura	Lanza de fibra de vidrio con empuñadura	Fiberglas-Sprühlanze mit Griff	Fiberglass lance with handle	14,10-
15	242/30	Impugnatura	Empuñadura	Griff	Handle	6,60-
16	242/31	Regolatore di flusso	Regulador de flujo	Wasserfluss-regulator	Flow regulator	5,50-
17	243/2	Viti di fissaggio per maniglia	Tornillos de fijación para manija	Fixierschrauben für Handgriff	Screws for fixing handle	2,20-



- ① Ricambi
- ⓔ Recambios
- ⓓ Ersatzteile
- Ⓞ Spare parts

Art. 245
Art. 244

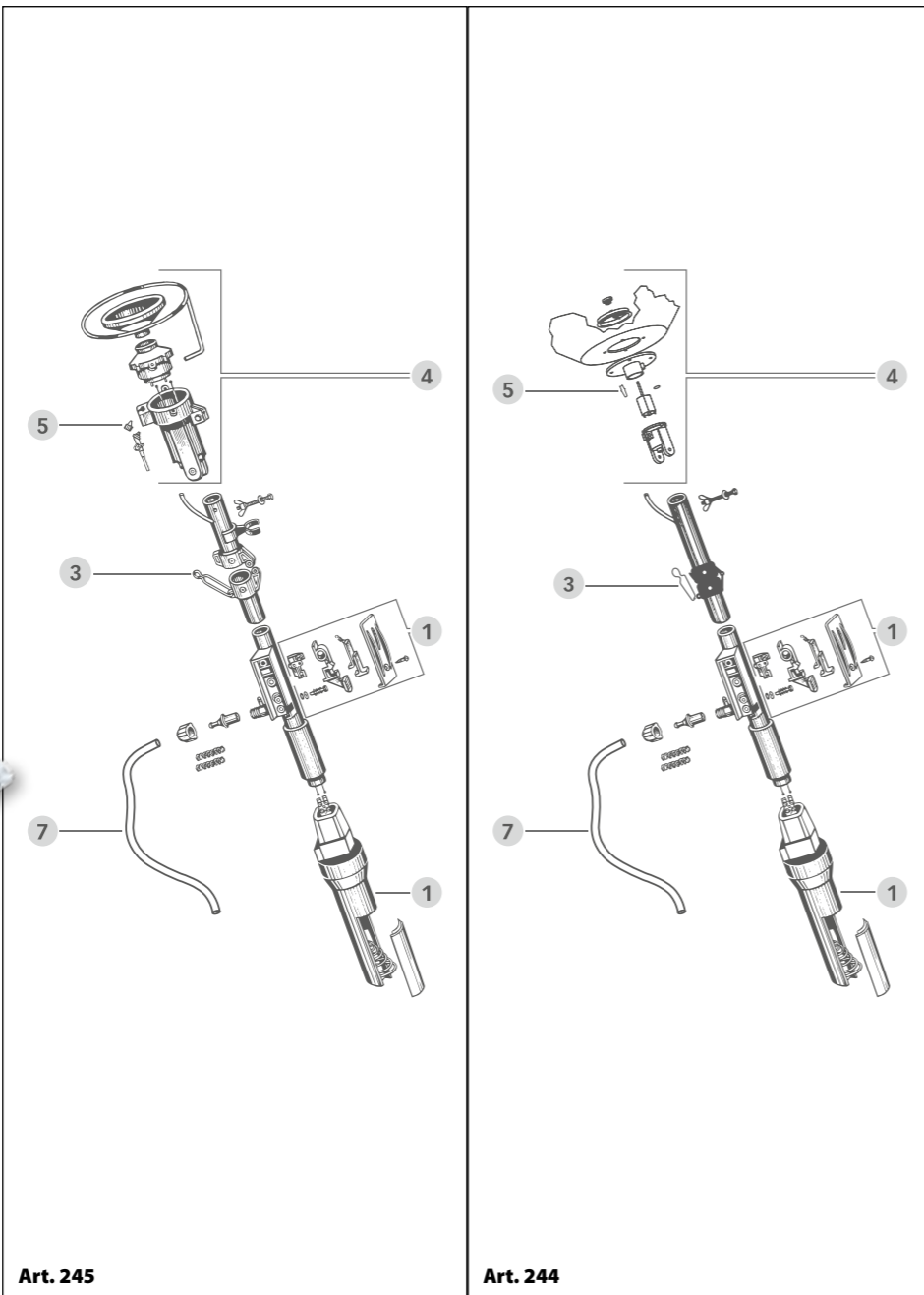

#	Art.	IT	ES	DE	EN	€
1	231/1	Interruttore e portabatteria	Interruptor y porta batería	Ein-/Aus-Schalter und Batteriefach	Power button and battery box	54,10-
3	231/8	Clip di chiusura	Clip de cierre	Verschlussclip	Locking clip	6,80-
4	233/1	Diffusore (Art. 244)	Difusor (Art. 244)	Sprühkopf (Art. 244)	Head (Art. 244)	49,20-
4	231/4	Diffusore (Art. 245)	Difusor (Art. 245)	Sprühkopf (Art. 245)	Head (Art. 245)	65,90-
5	231/5	Ugelli (Art. 245)	Boquillas (Art. 245)	Düsen (Art. 245)	Nozzles (Art. 245)	11,30-
5	233/2	Ugelli (Art. 244)	Boquillas (Art. 244)	Düsen (Art. 244)	Nozzles (Art. 244)	11,70-
7	244/1	Tubo	Tubo	Schlauch	Tube	5,60-



- ① Ricambi
- ⓔ Recambios
- ⓓ Ersatzteile
- Ⓞ Spare parts

Art. 231, 232

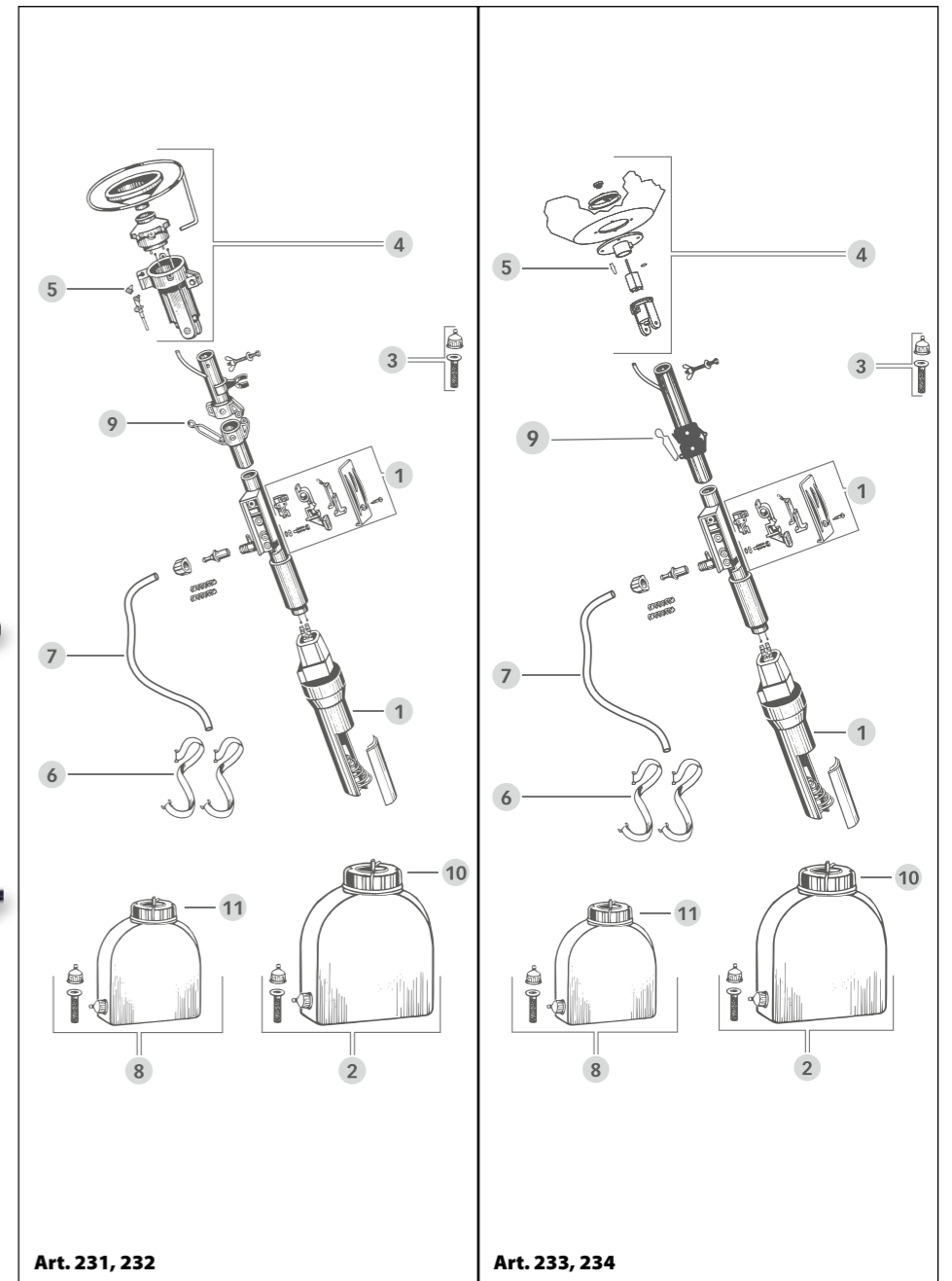

#	Art.	IT	ES	DE	EN	€
1	231/1	Interruttore e portabatteria	Interruptor y porta batería	Ein-/Aus-Schalter und Batteriefach	Power button and battery box	54,10-
2	231/2	Serbatoio 10 L	Tanque 10 L	Tank 10 L	Tank 10 L	39,70-
3	231/3	Filtro	Filtro	Filter	Filter	12,70-
4	231/4	Diffusore	Difusor	Sprühkopf	Head	65,90-
5	231/5	Ugelli micronizzatori	Boquillas pulverizadoras	Düse mit Nebelfunktion	Micronization nozzles	11,30-
6	231/6	Cinghie (Art. 231)	Correas (Art. 231)	Gurte (Art. 231)	Shoulder straps (Art. 231)	13,90-
6	232/2	Cinghie (Art. 232)	Correas (Art. 232)	Gurte (Art. 232)	Shoulder straps (Art. 232)	13,70-
7	231/7	Tubo	Tubo	Schlauch	Tube	4,90-
8	232/1	Serbatoio 5 L	Tanque 5 L	Tank 5 L	Tank 5 L	34,70-
9	231/8	Clip di chiusura	Clip de cierre	Verschlussclip	Locking clip	6,80-
10	231/9	Chiusura serbatoio (Art. 231)	Cierre tanque (Art. 231)	Verschluss Tank (Art. 231)	Tank cap (Art. 231)	11,70-
11	232/3	Chiusura serbatoio (Art. 232)	Cierre tanque (Art. 232)	Verschluss Tank (Art. 232)	Tank cap (Art. 232)	9,80-

Art. 233, 234

#	Art.	IT	ES	DE	EN	€
1	231/1	Interruttore e portabatteria	Interruptor y porta batería	Ein-/Aus-Schalter und Batteriefach	Power button and battery box	54,10-
2	231/2	Serbatoio 10 L	Tanque 10 L	Tank 10 L	Tank 10 L	39,70-
3	231/3	Filtro	Filtro	Filter	Filter	12,70-
4	233/1	Diffusore	Difusor	Sprühkopf	Head	49,20-
5	233/2	Ugelli micronizzatori	Boquillas pulverizadoras	Düse mit Nebelfunktion	Micronization nozzles	11,70-
6	231/6	Cinghie (Art. 234)	Correas (Art. 234)	Gurte (Art. 234)	Shoulder straps (Art. 234)	13,90-
6	232/2	Cinghie (Art. 233)	Correas (Art. 233)	Gurte (Art. 233)	Shoulder straps (Art. 233)	13,70-
7	231/7	Tubo	Tubo	Schlauch	Tube	4,90-
8	232/1	Serbatoio 5 L	Tanque 5 L	Tank 5 L	Tank 5 L	34,70-
9	231/8	Clip di chiusura	Clip de cierre	Verschlussclip	Locking clip	6,80-
10	231/9	Chiusura serbatoio (Art. 234)	Cierre tanque (Art. 234)	Verschluss Tank (Art. 234)	Tank cap (Art. 234)	11,70-
11	232/3	Chiusura serbatoio (Art. 233)	Cierre tanque (Art. 233)	Verschluss Tank (Art. 233)	Tank cap (Art. 233)	9,80-



- ① Ricambi
- Ⓔ Recambios
- Ⓓ Ersatzteile
- Ⓒ Spare parts

Art. 241

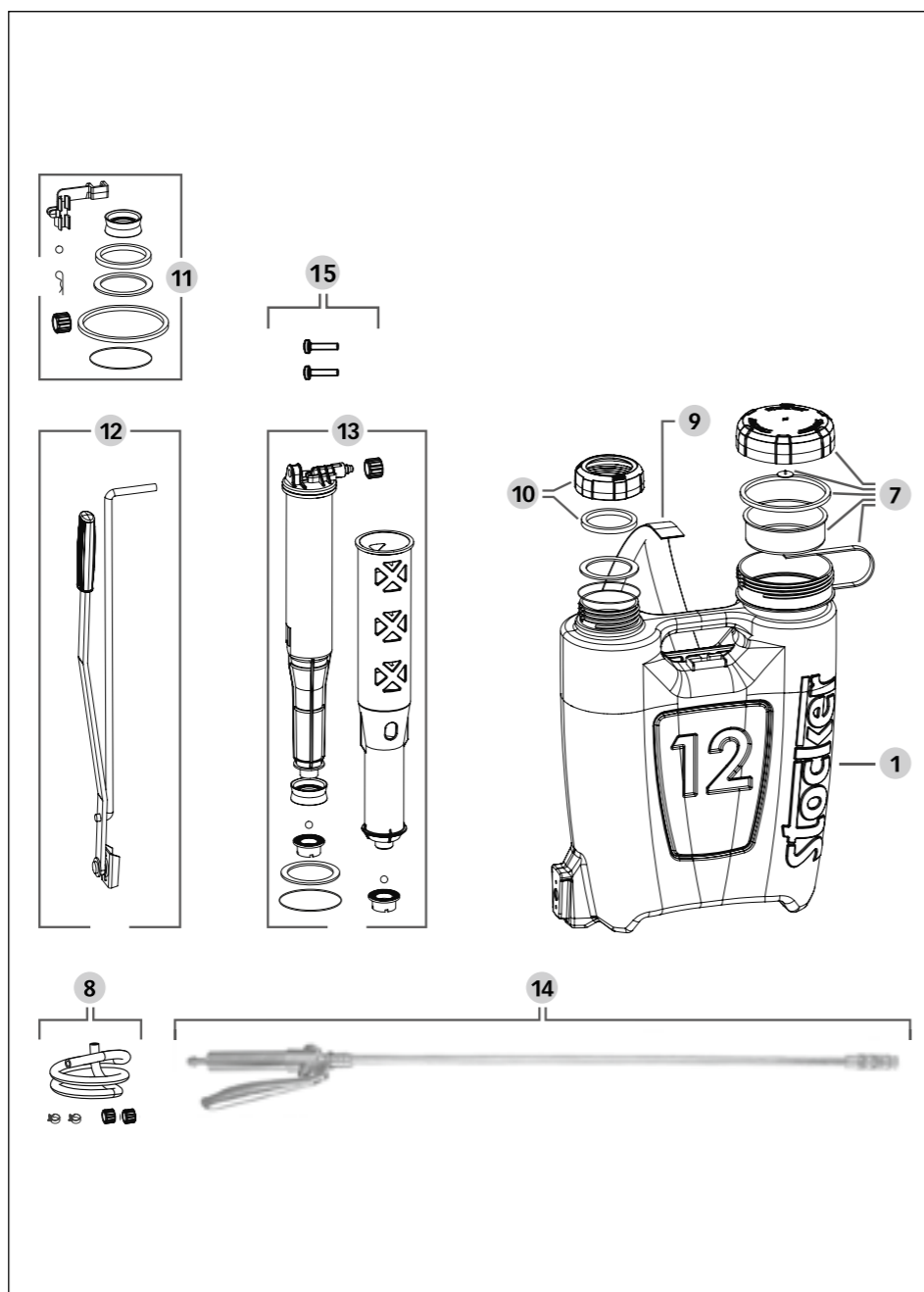

#	Art.	IT	ES	DE	EN	€
1	243/1	Serbatoio 12 L	Tanque 12 L	Tank 12 L	Tank 12 L	33,40-
7	242/8	Tappo e filtro	Tapón y filtro	Deckel und Filter	Cap and filter	5,00-
8	242/11	Tubo di mandata, raccordi e fascette	Tubo de entrada, conectores y abrazaderas	Verbindungsschlauch	Delivery tube, connectors and clamps	8,00-
9	R-253	Cinghia	Correa	Gurt	Straps	5,30-
10	243/21	Ghiera e guarnizione	Cápsula y junta	Gewinding und Dichtung	Ring nut and seal	1,50-
11	243/22	Set O-Ring	Set O-Rings	Set O-Ring	O-Rings set	4,60-
12	M-253	Manico per pompante	Mango para bombeador	Pumphebel	Handle for pumper	9,20-
13	241/27	Pompante in ottone	Bombeador de latón	Messing-Pumpvorrichtung	Brass pumper	41,40-
14	G-260	Lancia in ottone con impugnatura e fascetta	Lanza de latón con empuñadura y abrazadera	Messing-Sprühlanze mit Griff und Schellen	Brass lance with handle and clamp	21,70-
15	243/2	Viti di fissaggio per maniglia	Tornillos de fijación para manija	Fixierschrauben für Handgriff	Screws for fixing handle	2,20-



- ① Ricambi
- Ⓔ Recambios
- Ⓓ Ersatzteile
- Ⓒ Spare parts

Art. 240

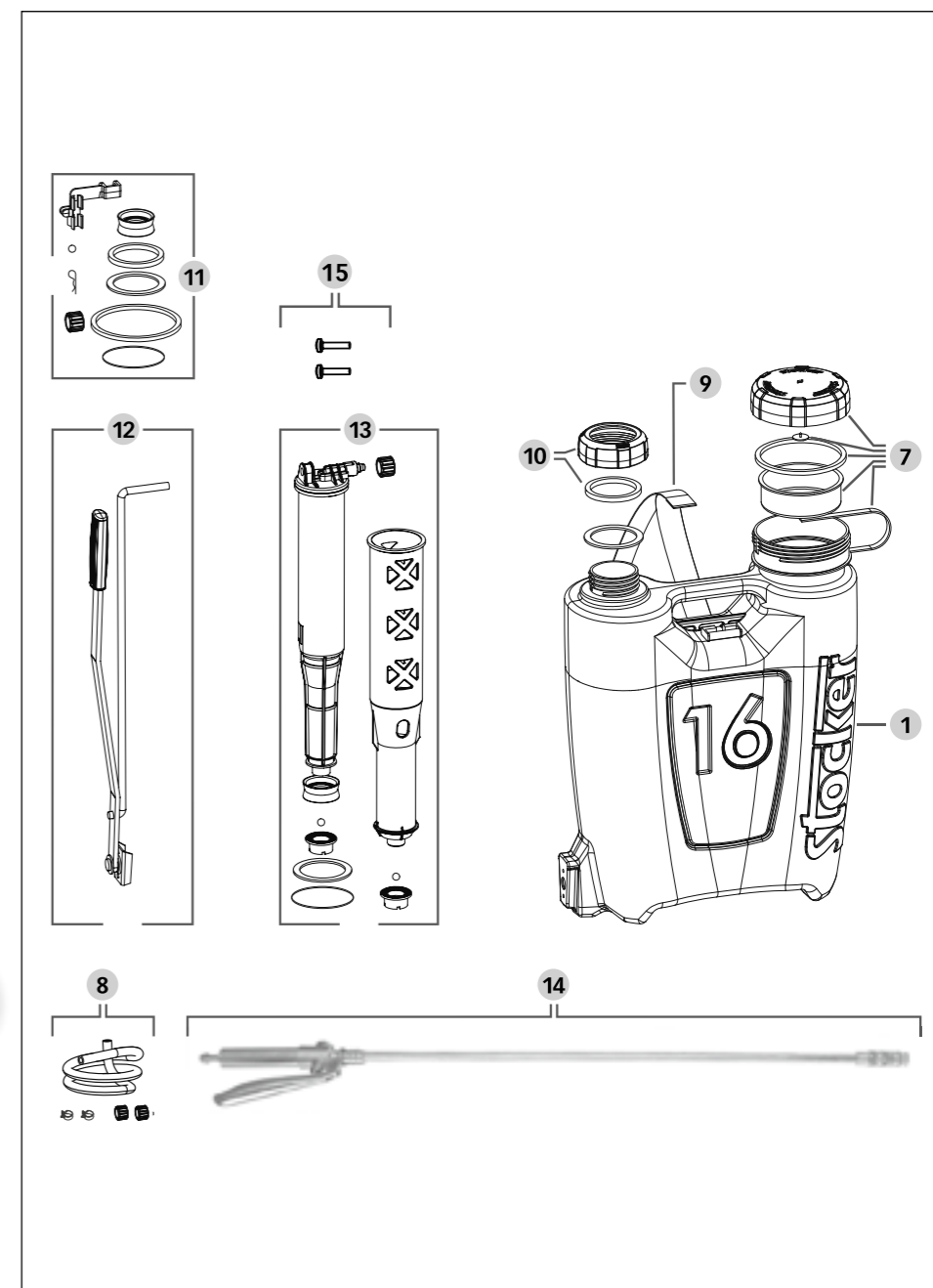

#	Art.	IT	ES	DE	EN	€
1	248/1	Serbatoio 16 L	Tanque 16 L	Tank 16 L	Tank 16 L	36,00-
7	242/8	Tappo e filtro	Tapón y filtro	Deckel und Filter	Cap and filter	5,00-
8	242/11	Tubo di mandata, raccordi e fascette	Tubo de entrada, conectores y abrazaderas	Verbindungsschlauch	Delivery tube, connectors and clamps	8,00-
9	R-253	Cinghia	Correa	Gurt	Straps	5,30-
10	243/21	Ghiera e guarnizione	Cápsula y junta	Gewinding und Dichtung	Ring nut and seal	1,50-
11	243/22	Set O-Ring	Set O-Rings	Set O-Ring	O-Rings set	4,60-
12	248/24	Manico	Mango	Griff	Handle	9,00-
13	P260	Pompante	Bombeador	Pumpvorrichtung	Pumper	41,50-
14	G-260	Lancia in ottone con impugnatura e fascetta	Lanza de latón con empuñadura y abrazadera	Messing-Sprühlanze mit Griff und Schellen	Brass lance with handle and clamp	21,70-
15	243/2	Viti di fissaggio per maniglia	Tornillos de fijación para manija	Fixierschrauben für Handgriff	Screws for fixing handle	2,20-



- Ⓘ Ricambi
- Ⓔ Recambios
- Ⓓ Ersatzteile
- Ⓒ Spare parts

Art. 242

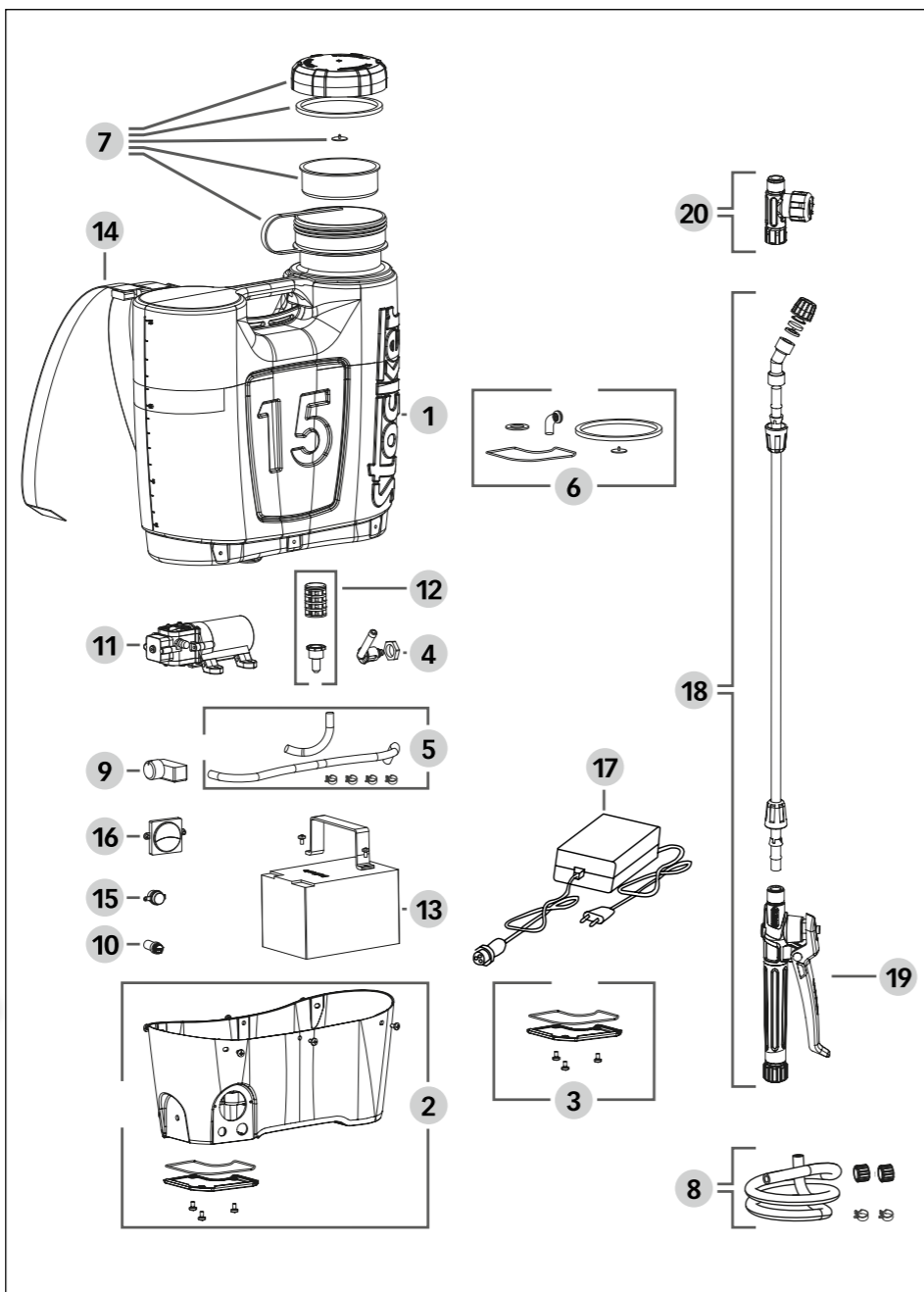

#	Art.	IT	ES	DE	EN	€
1	242/1	Serbatoio 15 L	Tanque 15 L	Tank 15 L	Tank 15 L	35,70-
2	242/2	Base serbatoio in plastica	Base tanque de plástico	Plastik-Basis Tank	Plastic tank base	25,00-
3	242/3	Coperchio circuito, viti e guarnizioni	Tapa circuito, tornillos y juntas	Deckel Sicherung, Schrauben und Dichtungen	Circuit cap, screws and seals	2,10-
4	242/4	Raccordo tubo lancia	Conector tubo lanza	Verbindung für Schlauch und Lance	Lance-tube connector	1,50-
5	242/6	Tubo mandata motore e fascette in metallo	Tubo entrada motor y abrazaderas de metal	Motor-Verbindungsschlauch mit Metallschellen	Engine's delivery tube and metal clamps	4,20-
6	242/7	Kit guarnizioni	Kit juntas	Set Dichtungen	Seals kit	30,70-
7	242/8	Tappo e filtro	Tapón y filtro	Deckel und Filter	Cap and filter	5,00-
8	242/11	Tubo di mandata, raccordi e fascette	Tubo de entrada, conectores y abrazaderas	Verbindungsschlauch	Delivery tube, connectors and clamps	8,00-
9	242/14	Potenziometro	Potenciómetro	Druckregler	Potentiometer	17,10-
10	242/15	Fusibile	Fusible	Sicherung	Fuse	2,60-
11	252/35	Pompa di ricambio	Bomba de recambio	Ersatzpumpe	Spare pump	66,60-
12	252/40	Filtro	Filtro	Filter	Filter	2,90-
13	B-252	Batteria	Batería	Batterie	Battery	58,80-
14	251/64	Cinghia	Correa	Tragegurt	Shoulder strap	10,70-
15	251/46	Connessione alimentatore	Conexión fuente de alimentación	Ladeanschluss	Charging connection	4,50-
16	252/30	Indicatore di carica	Indicador de carga	Spannungsmesser	Voltmeter	7,30-
17	C-252	Caricabatteria	Cargador	Aufladegerät	Battery charger	49,50-
18	242/29	Lancia in fibra di vetro con impugnatura	Lanza de fibra de vidrio con empuñadura	Fiberglas-Sprühlanze mit Griff	Fiberglass lance with handle	14,10-
19	242/30	Impugnatura	Empuñadura	Griff	Handle	6,60-
20	242/31	Regolatore di flusso	Regulador de flujo	Wasserfluss-regulator	Flow regulator	5,50-

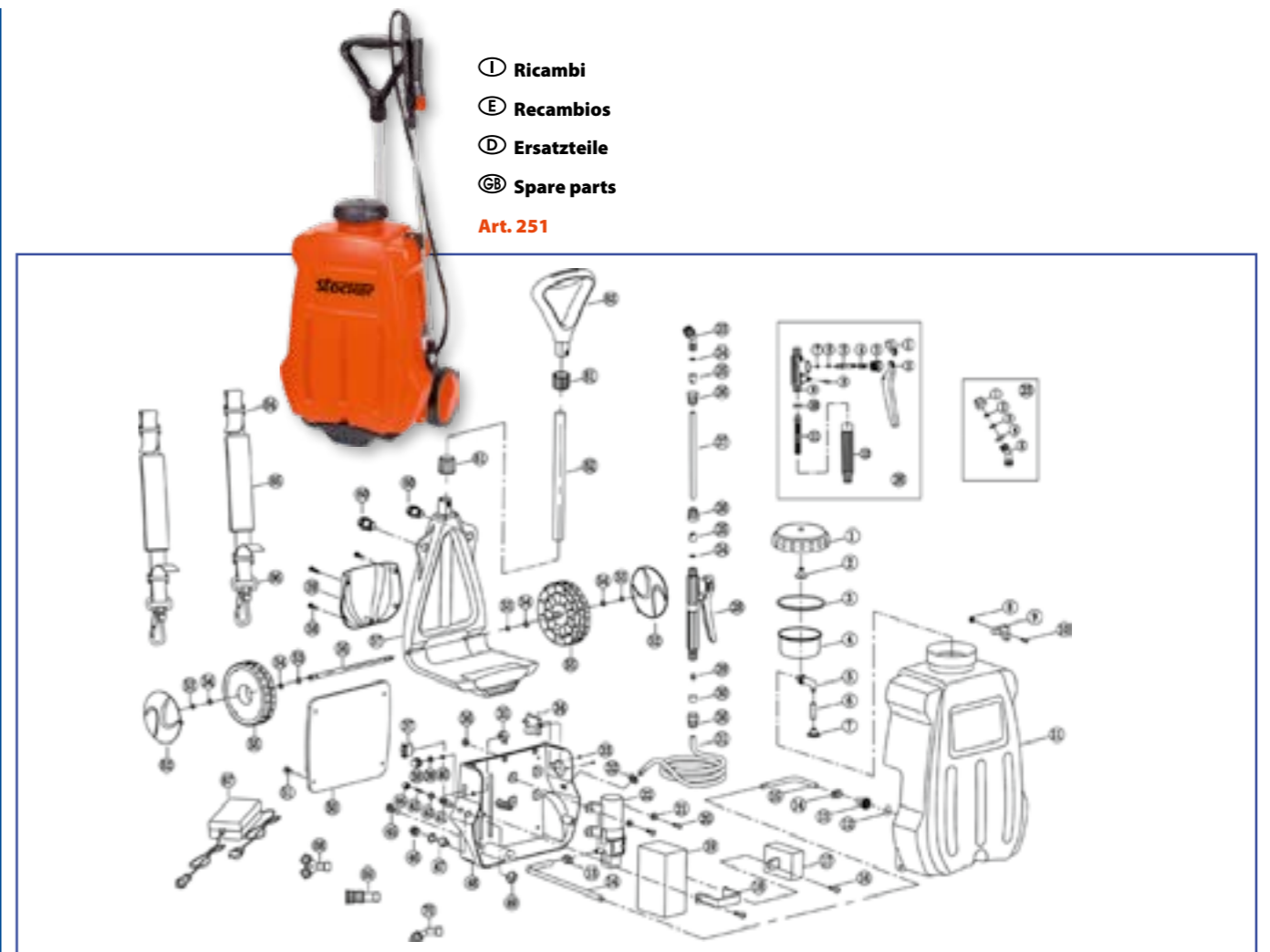

- Ⓘ Ricambi
- Ⓔ Recambios
- Ⓓ Ersatzteile
- Ⓒ Spare parts

Art. 251



- Ⓘ Ricambi
- Ⓔ Recambios
- Ⓓ Ersatzteile
- Ⓒ Spare parts

Art. 252

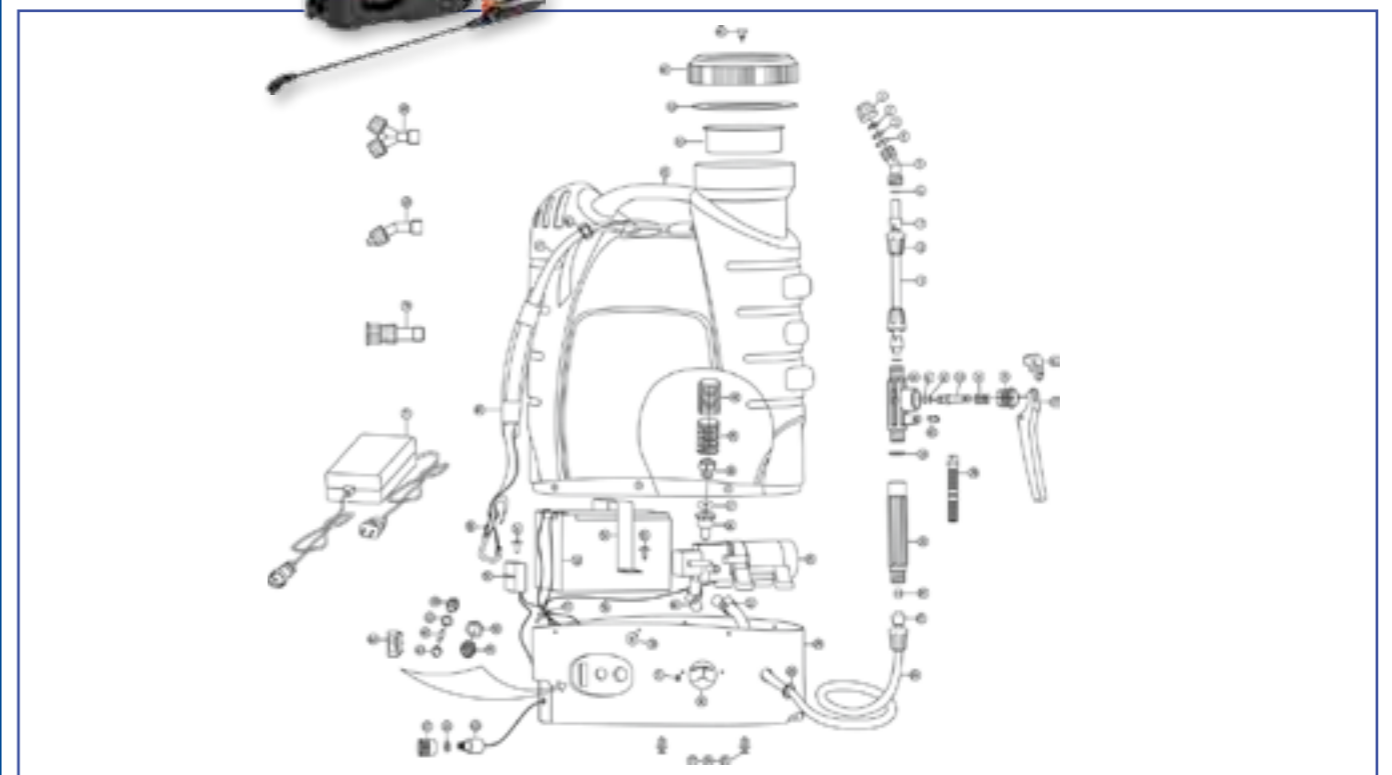

Stocker
Brucia erbacce
Quemador de malas hierbas
 Unkrautbrenner
 Weed-killer



- Ⓘ Ricambi
- Ⓔ Recambios
- Ⓓ Ersatzteile
- Ⓒ Spare parts

Art. 308

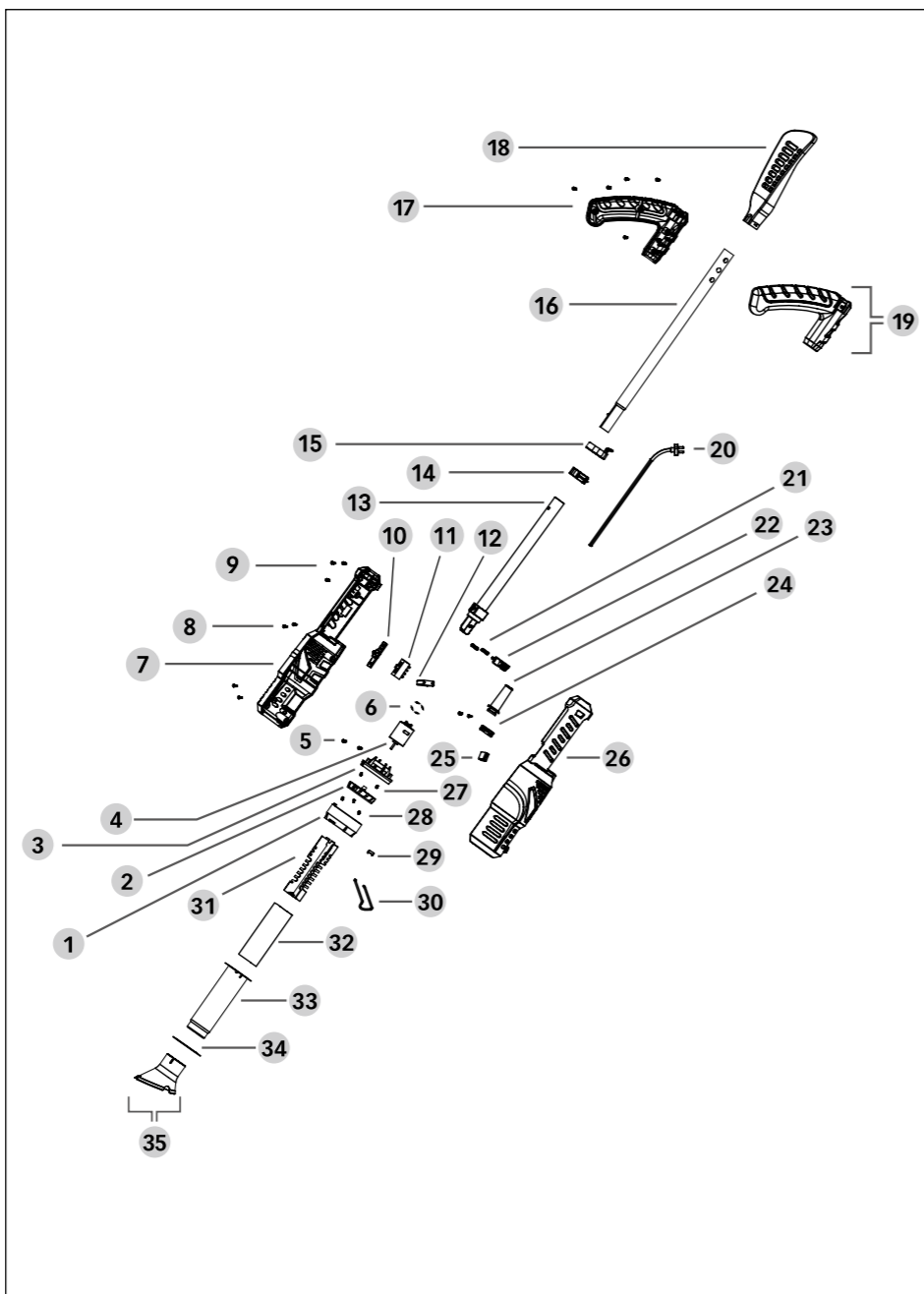

#	Art.	IT	ES	DE	EN	€
17 + 18 + 19 + viti/tornillos/Schrauben/screws	308/1	Impugnatura	Empuñadura	Griff	Handle	9,50-
13 + 14 + 15 + 16	308/2	Corpo	Cuerpo	Körper	Body	8,30-
7 + 8 + 9 + 10 + 21 + 22 + 24 + 26 + 30 + viti/tornillos/Schrauben/screws	308/3	Copertura	Cobertura	Abdeckung	Cover	11,90-
20 + 23	308/4	Cavo di alimentazione	Cable de alimentación	Kabel	Cable	8,10-
1 + 2 + 3 + 4 + 5 + 6 + 7 + 10 + 11 + 12 + 25 + 27 + 28 + 29 + 31 + 32 + 33 + 34	308/5	Motore con interruttore	Motor con interruptor	Motor mit Ein-/Ausschalter	Motor with power button	17,90-
35	308/6	Ugello a cono	Boquilla de cono	Kegeldüse	Conic nozzle	3,80-
Tutte le viti/todos los tornillos/alle Schrauben/all screws	308/7	Kit viti completo	Kit tornillos completo	Kit Schrauben komplett	Complete screws set	5,50-

Stocker
Spandiconcime
Espande-abono
 Streuwagen
 Fertilizer spreaders



- Ⓘ Ricambi
- Ⓔ Recambios
- Ⓓ Ersatzteile
- Ⓒ Spare parts

Art. 3906

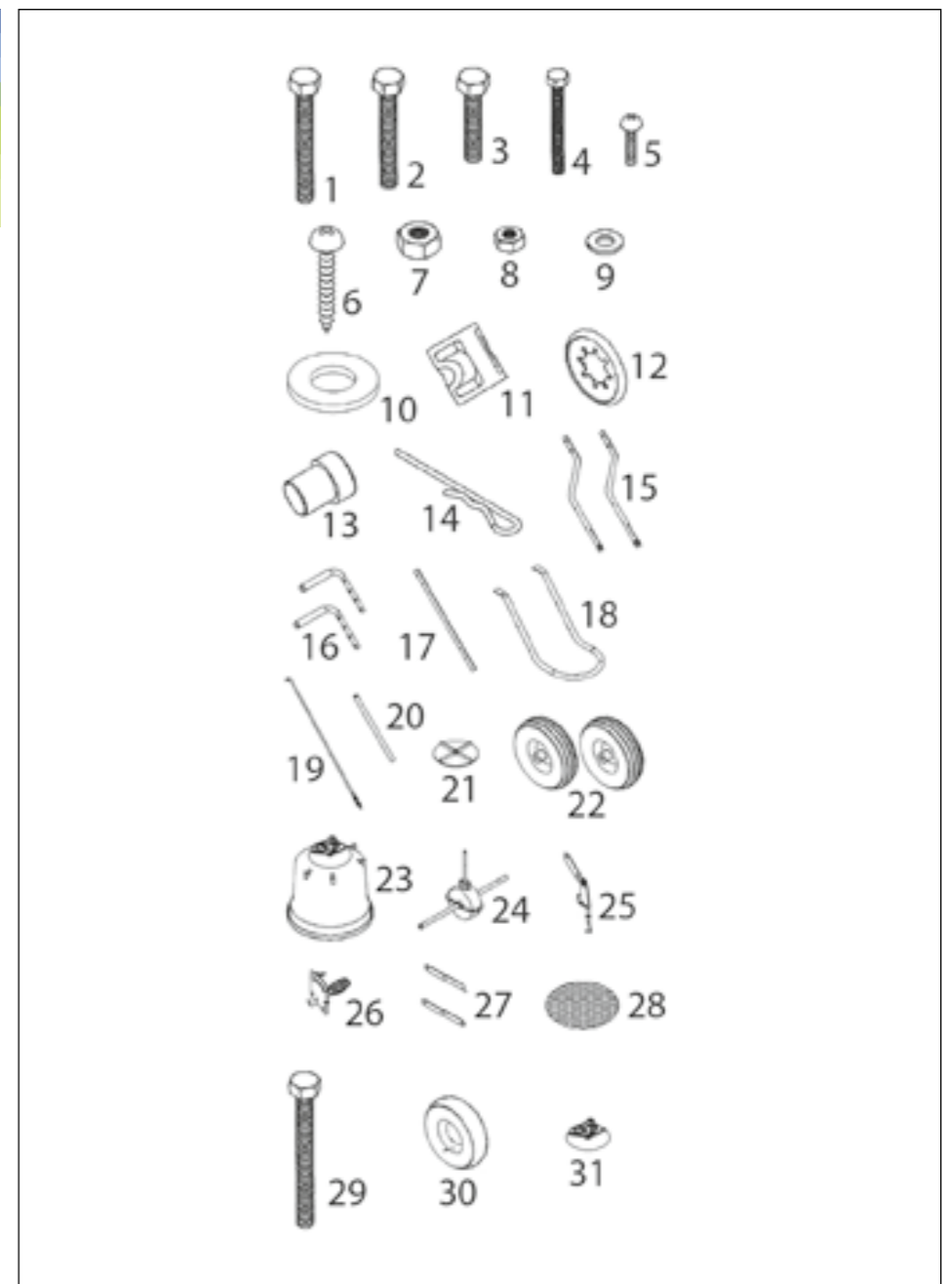

#	Art.	IT	ES	DE	EN	€
1	S-3908/15	Bullone M6 x 50	Bulón M6 x 50	Bolzen M6 x 50	Hex Bolt M6 x 50	2,10-
2	S-3906/2	Bullone M6 x 45	Bulón M6 x 45	Bolzen M6 x 45	Hex Bolt M6 x 45	2,30-
3	S-3906/3	Bullone M6 x 30	Bulón M6 x 30	Bolzen M6 x 30	Hex Bolt M6 x 30	2,10-
4	S-3906/4	Bullone M5 x 45	Bulón M5 x 45	Bolzen M5 x 45	Hex Bolt M5 x 45	2,10-
5	S-3906/5	Bullone M4 x 20	Bulón M4 x 20	Bolzen M4 x 20	Hex Bolt M4 x 20	1,50-
6	S-3906/6	Vite M6 x 40	Tornillo M6 x 40	Schraube M6 x 40	Screw M6 x 40	1,50-
7	S-3906/7	Dado M6	Tuerca M6	Schraubenmutter M6	Locking Nut M6	1,30-
8	S-3906/8	Dado M5	Tuerca M5	Schraubenmutter M5	Locking Nut M5	1,30-
9	S-3906/9	Rondella Ø 6	Arandela Ø 6	Beilagscheibe Ø 6	Flat washer Ø 6	0,90-
10	S-3906/10	Rondella Ø 16	Arandela Ø 16	Beilagscheibe Ø 16	Flat washer Ø 16	2,10-
11	S-3906/11	Pezzo intermedio	Pieza intermedia	Zwischenstück	Middle piece	2,10-
12	S-3906/12	Tappo terminale	Tapón terminal	Abchlusskappe	Cap	3,60-
13	S-3906/13	Bussola	Brújula	Plastikbüchse	Bushing	2,30-
14	S-3906/14	Perno	Perno	Stift	R pin	2,80-
15	S-3906/15	Montante delle ruote	Montante de las ruedas	Radhalter	Wheel assembly frame	29,00-
16	S-3906/16	Manico	Mango	Griff	Handle	18,00-
17	S-3906/17	Stelo	Asta	Stiel	Pole	18,80-
18	S-3906/18	Piede	Pie	Stütze	Foot	32,70-
19	S-3906/19	Asta in metallo	Asta de metal	Regulierstange	Metal rod	2,70-
20	S-3906/20	Stabilizzatore	Estabilizador	Stabilisator	Stabilizer	15,00-
21	S-3906/21	Ventola	Ventilador	Wurfscheibe	Rotor	25,20-
22	S-3906/22	Ruota	Rueda	Rad	Wheel	77,20-
23	S-3906/23	Serbatoio	Tanque	Tank	Tank	52,50-
24	S-3906/24	Ingranaggio	Engranaje	Getriebebox	Gear	69,60-
25	S-3906/25	Braccio	Brazo	Bügel	Arm	19,90-
26	S-3906/26	Leva	Palanca	Wurfregulierer	Lever	34,70-
27	S-3906/27	Sostegni	Sostenes	Platzhalter	Support rod	10,40-
28	S-3906/28	Grata di protezione	Rejilla de protección	Schutzgitter	Protective screen	16,50-
29	S-3906/1	Bullone M6 x 65	Bulón M6 x 65	Bolzen M6 x 65	Hex Bolt M6 x 65	2,80-
30	S-3906/22c	Camera d'aria	Luftschlauch	Inner tube for wheel	Inner tube for wheel	7,50-
31	S-3906/23s	Base serbatoio	Base tanque	Boden für Tank	Tank base	3,80-



- ① Ricambi
- Ⓔ Recambios
- Ⓓ Ersatzteile
- Ⓒ Spare parts

Art. 3907

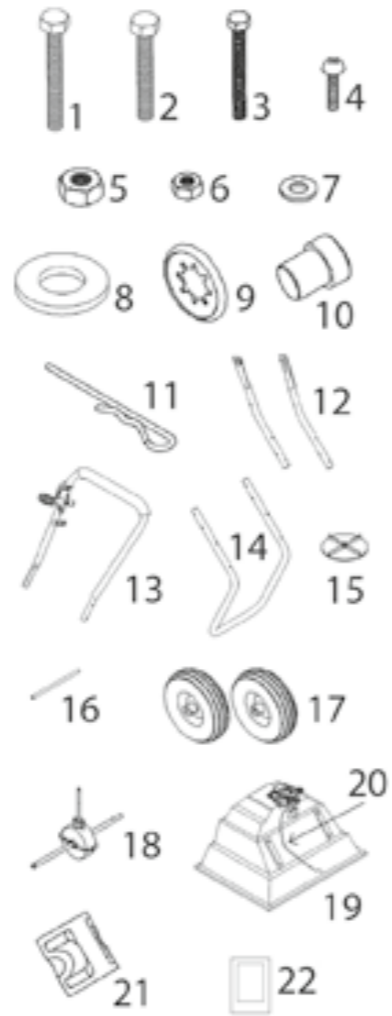

#	Art.	IT	ES	DE	EN	€
1	S-3906/1	Bullone M6 x 65	Bulón M6 x 65	Bolzen M6 x 65	Hex Bolt M6 x 65	2,80-
2	S-3907/2	Bullone M6 x 40	Bulón M6 x 40	Bolzen M6 x 40	Hex Bolt M6 x 40	2,30-
3	S-3906/4	Bullone M5 x 45	Bulón M5 x 45	Bolzen M5 x 45	Hex Bolt M5 x 45	2,10-
4	S-3906/5	Bullone M4 x 20	Bulón M4 x 20	Bolzen M4 x 20	Hex Bolt M4 x 20	1,50-
5	S-3906/7	Dado M6	Tuerca M6	Schraubenmutter M6	Locking Nut M6	1,30-
6	S-3906/8	Dado M5	Tuerca M5	Schraubenmutter M5	Locking Nut M5	1,30-
7	S-3906/9	Rondella Ø 6	Arandela Ø 6	Beilagscheibe Ø 6	Flat washer Ø 6	0,90-
8	S-3906/10	Rondella Ø 16	Arandela Ø 16	Beilagscheibe Ø 16	Flat washer Ø 16	2,10-
9	S-3906/12	Tappo terminale	Tapón terminal	Abchlusskappe	Cap	3,60-
10	S-3906/13	Bussola	Brújula	Plastikbüchse	Bushing	2,30-
11	S-3906/14	Perno	Perno	Stift	R pin	2,80-
12	S-3907/12	Semiassa delle ruote	Semieje de las ruedas	Radhalterung	Axle of tires	18,80-
13	S-3907/13	Manico	Mango	Griff	Handle	73,30-
14	S-3907/14	Piede	Pie	Stütze	Support leg	50,90-
15	S-3906/21	Ventola	Ventilador	Wurfscheibe	Rotor	25,20-
16	S-3907/16	Stabilizzatore	Estabilizador	Stabilisator	Stabilizer	10,40-
17	S-3906/22	Ruota	Rueda	Rad	Wheel	77,20-
18	S-3906/24	Ingranaggio	Engranaje	Getriebebox	Gear	69,60-
19	S-3907/19	Serbatoio	Tanque	Behälter	Tank	61,70-
20	S-3907/30	Cavo di controllo	Cable de control	Kontrollkabel	Control cable	4,10-
21	S-3906/11	Pezzo intermedio	Pieza intermedia	Zwischenstück	Middle piece	2,10-
22	S-3907/31	Chiusura	Cierre	Verschluss	Lock	2,10-



- ① Ricambi
- Ⓔ Recambios
- Ⓓ Ersatzteile
- Ⓒ Spare parts

Art. 3908



#	Art.	IT	ES	DE	EN	€
1	S-3908/1	Leva	Palanca	Wurfregulierer	Lever	23,70-
2	S-3908/2	Ingranaggio	Engranaje	Getriebe	Gear	92,40-
3	S-3908/3	Serbatoio	Tanque	Tank	Tank	116,00-
4	S-3908/4	Sostegno	Sostén	Stütze	Support rod	22,80-
5	S-3908/5	Innesto	Injerto	Kupplung	Hitch bracket	25,80-
6	S-3908/6	Montante	Montante	Abstandhalter	Brace	10,40-
7	S-3908/7	Gamba	Soporte	Strebe	Support rod	10,40-
8	S-3908/8	Ruote	Ruedas	Räder	Tire	65,30-
9	S-3908/9	Asta in metallo	Asta de metal	Kupplungsarm	Metal tube	19,50-
10	S-3908/10	Grata di protezione	Rejilla de protección	Schutzgitter	Protective screen	18,00-
11	S-3908/11	Protezione	Protección	Schutz	Protection	22,80-
12	S-3908/12	Bullone M6 x 20	Bulón M6 x 20	Bolzen M6 x 20	Hex Bolt M6 x 20	0,90-
13	S-3908/13	Bullone M6 x 40	Bulón M6 x 40	Bolzen M6 x 40	Hex Bolt M6 x 40	1,30-
14	S-3908/14	Bullone M6 x 45	Bulón M6 x 45	Bolzen M6 x 45	Hex Bolt M6 x 45	2,10-
15	S-3908/15	Bullone M6 x 50	Bulón M6 x 50	Bolzen M6 x 50	Hex Bolt M6 x 50	2,10-
16	S-3908/16	Bullone M8 x 40	Bulón M8 x 40	Bolzen M8 x 40	Hex Bolt M8 x 40	2,80-
17	S-3908/17	Bullone M8 x 45	Bulón M8 x 45	Bolzen M8 x 45	Hex Bolt M8 x 45	2,80-
18	S-3908/18	Dado M6	Tuerca M6	Schraubenmutter M6	Lock Nut M6	1,10-
19	S-3908/19	Dado M8	Tuerca M8	Schraubenmutter M8	Lock Nut M8	1,10-
20	S-3906/9	Rondella Ø 6	Arandela Ø 6	Beilagscheibe Ø 6	Flat washer Ø 6	0,90-
21	S-3908/21	Rondella Ø 8	Arandela Ø 8	Beilagscheibe Ø 8	Flat washer Ø 8	0,60-
22	S-3908/22	Rondella	Arandela	Beilagscheibe	Flat washer	2,10-
23	S-3908/23	Rondella Ø 20	Arandela Ø 20	Beilagscheibe Ø 20	Flat washer Ø 20	2,10-
24	S-3908/24	Perno	Perno	Stift	R Pin	5,80-
25	S-3908/25	Bussola	Brújula	Büchse	Bushing	9,10-
26	S-3908/26	Copiglia	Chaveta	Splint	Drive pin	10,40-
27	S-3908/27	Copiglia Ø 4x20	Chaveta Ø 4x20	Splint Ø 4x20	Cotter pin Ø 4x20	2,70-
28	S-3908/20	Ingranaggio piccolo	Engranaje pequeño	Zahnrad klein	Small gear	3,90-
29	S-3908/30	Cavo di controllo	Cable de control	Kontrollkabel	Control cable	3,30-
30	S-3908/31	Ingranaggio grande	Engranaje grande	Zahnrad groß	Big gear	11,40-



- ① Ricambi
- Ⓔ Recambios
- Ⓓ Ersatzteile
- Ⓒ Spare parts

Art. 3914

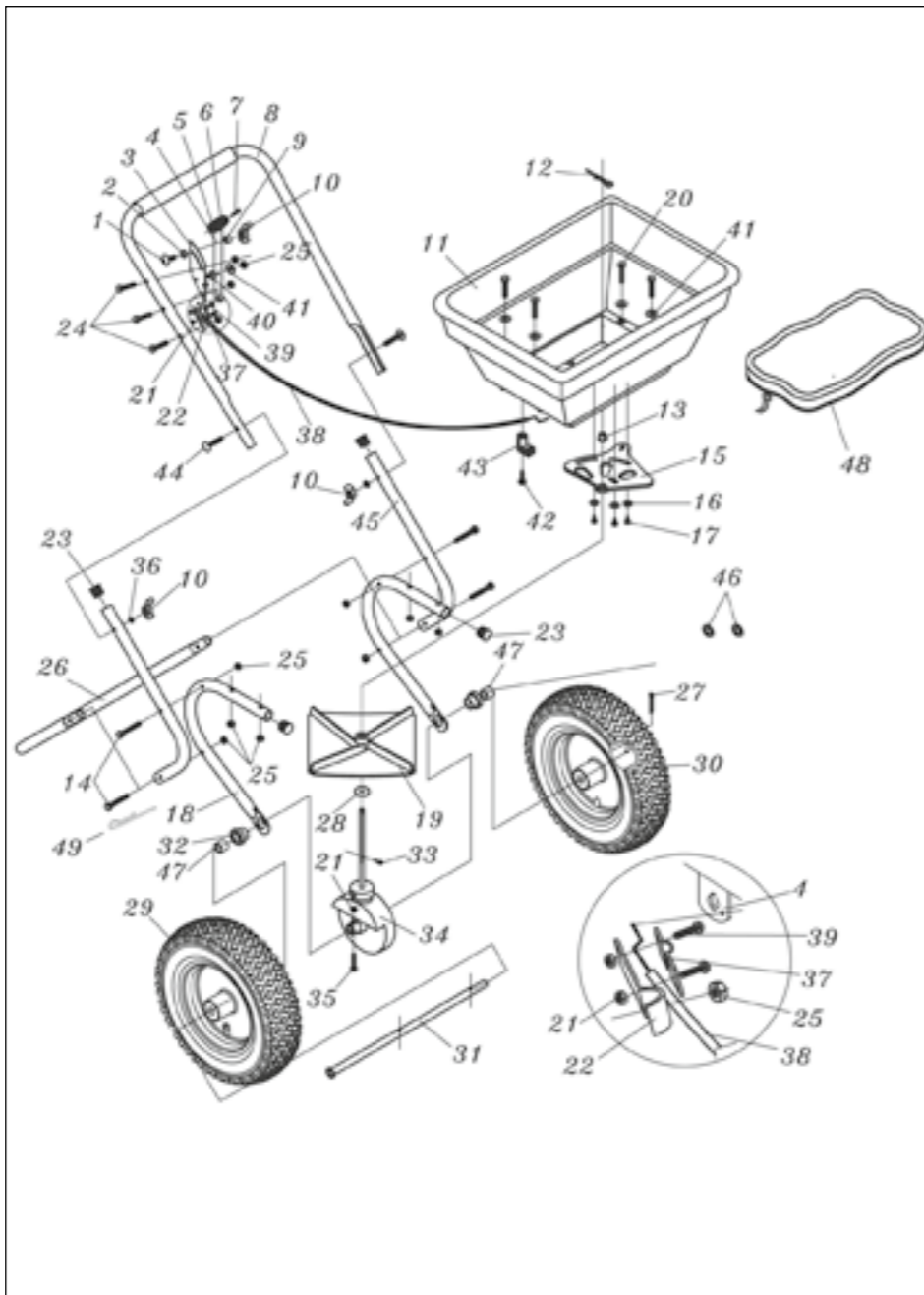

#	Art.	IT	ES	DE	EN	€
1+2+3+4+5+6+7+8+9+10+24(x2)+25(x3)+40+41	3914/1	Manico e manopola di dosaggio	Mango y manopla de dosificación	Griff und Dosierhalteriem	Handle and dosage knob	31,10-
24+25+21(x2)+39(x2)+22+37	3914/2	Fissaggio per filo in metallo a manopola di dosaggio	Fijación para hilo de metal a manopla de dosificación	Fixierung für Metalldraht zu Dosierhalteriem	Fastening for metal wire to dosage knob	3,80-
38	3914/3	Filo in metallo e tubo in plastica	Hilo de metal y tubo de plástico	Metalldraht und Kunststoffrohr	Metal wire and plastic tube	4,80-
42+43	3914/4	Fissaggio per filo in metallo a serbatoio	Fijación para hilo de metal a tanque	Fixierung für Metalldraht zu Tank	Fastening for metal wire to tank	1,50-
44(x2)+36(x2)+10(x2)	3914/5	Viti e bulloni per fissaggio del manico	Tornillos y bulones para fijación del mango	Schrauben und Bolzen für Griff Fixierung	Screws and bolts for handle fastening	6,10-
26	3914/6	Sostegno metallico a forma di U	Sostén metálico con forma de U	U-förmige Metallstütze	Metal U-shaped support	11,80-
45(x2)+14(x4)+25(x4)+23(x2)	3914/7	Tubo metallico a forma di L tra manico e sostegno	Tubo metálico con forma de L entre tanque y sostén	Metallrohr L-förmige zwischen Griff und Stütze	Metal L-shaped tube between handle and support	25,60-
18(x2)+25(x4)+20(x4)+41(x4)+32(x2)+23(x2)	3914/8	Tubo metallico a forma di V tra serbatoio e asse	Tubo metálico con forma de V entre tanque y eje	Metallrohr V-förmige zwischen Tank und Asse	Metal V-shaped tube between tank and axle	22,10-
29	3914/9	Ruota destra	Rueda derecha	Rechtes Rad	Right wheel	43,20-
30+27	3914/10	Ruota sinistra e fissaggio	Rueda izquierda y fijación	Linkes Rad und Fixierung	Left wheel and fastening	43,20-
31	3914/11	Asse	Eje	Achse	Axle	6,00-
34+19+35+21+33+28+12	3914/12	Ingranaggio, ventola, viti e spilla di fissaggio	Engranaje, ventilador, tornillos y broche de fijación	Getriebe, Rad, Schrauben, Fixierungsbrosche	Gear, fan, screws, fastening pin	30,80-
15+16(x3)+17(x3)+13	3914/13	Apertura in plastica sotto il serbatoio e viti	Apertura de plástico debajo del tanque y tornillos	Kunststoff Öffnung unter dem Tank und Schrauben	Plastic opening under the tank and screws	5,50-
11	3914/14	Serbatoio	Tanque	Tank	Tank	30,40-
46	3914/15	Rondelle per ruote	Arandelas para ruedas	Unterlegscheiben für Räder	Washers for wheel	1,10-
47	3914/16	Distanzatori per ruote	Distanciadores para ruedas	Abstandhalter für Räder	Spacer for wheels	3,30-
48	3914/17	Telo trasparente	Tela trasparente	Durchsichtige Plastikplane	Transparent foil	10,00-
12+33+27+47(x2)+10(x2)+36(x2)+44(x2)+41(x4)+35+21+14(x4)+20(x4)+24(x2)+46(x2)+25(x10)	3914/18	Kit viti	Kit tornillos	Kit Schrauben	Screws set	11,20-
49	S-3906/14	Perno	Perno	Stift	R pin	2,80-



- ① Ricambi
- Ⓔ Recambios
- Ⓓ Ersatzteile
- Ⓒ Spare parts

Art. 3915

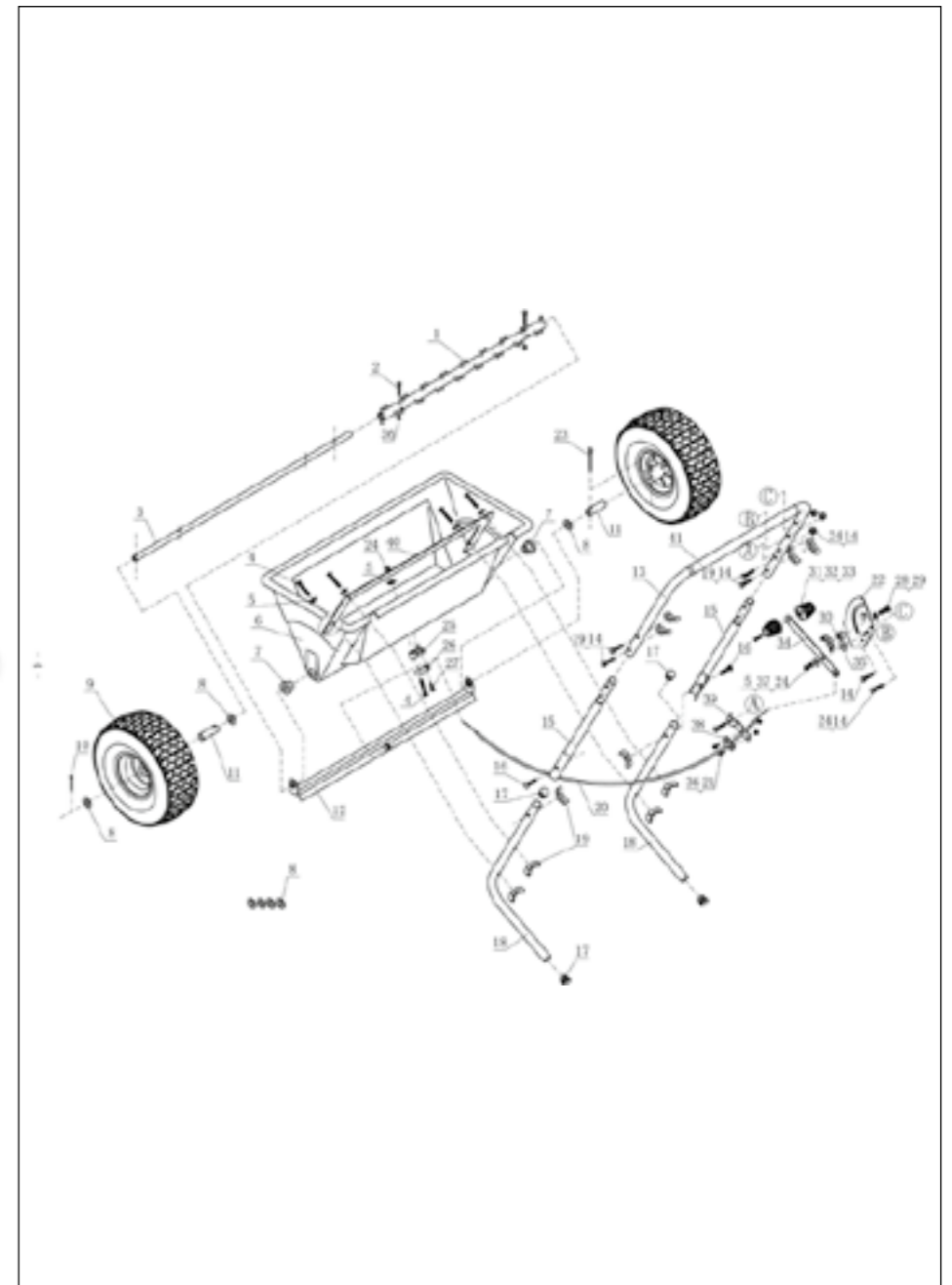

#	Art.	IT	ES	DE	EN	€
19+22+28+29+30+35+14(x2)+24(x3)+5+37+34+31+32+33	3915/1	Manopola di dosaggio e viti	Manopla de dosificación y tornillos	Regler für Dosierung und Schrauben	Dosage knob and screws	20,00-
38+39/21(x2)+36(x2)+24+14	3915/2	Fissaggio per filo in metallo e manopola di dosaggio	Fijación para hilo de metal y manopla de dosificación	Fixierung für Metalldraht zu Dosierhalteriem	Fastening for metal wire to dosage knob	3,90-
20	3915/3	Filo in metallo e tubo in plastica	Hilo de metal y tubo de plástico	Metalldraht und Kunststoffrohr	Metal wire and plastic tube	4,80-
4+5+24+25+26+27	3915/4	Fissaggio per filo in metallo a serbatoio	Fijación para hilo de metal a tanque	Fixierung für Metalldraht zu Tank	Fastening for metal wire to tank	4,10-
9+23+11+8	3915/5	Ruota destra, spilla di fissaggio e distanziatore	Rueda derecha, broche de fijación y distanciator	Rechtes Rad, Fixierungsbrosche und Abstandhalter	Right wheel, fastening pin and spacer	45,50-
9+10+8(x2)+11	3915/6	Ruota sinistra, spilla di fissaggio e distanziatore	Rueda izquierda, broche de fijación y distanciator	Linkes Rad, Fixierungsbrosche und Abstandhalter	Left wheel, fastening pin and spacer	45,50-
13+14(x4)+19(x4)+41	3915/7	Manico e viti	Mango y tornillos	Griff und Schrauben	Handle and screws	25,30-
15(x2)+16(x2)+19(x2)	3915/8	Tubo metallico tra manico e sostegno	Tubo metálico entre manico y sostén	Metallrohr zwischen Griff und Stütze	Metal tube between handle and support	12,60-
18(x2)+17(x4)+4(x4)+5(x4)+19(x4)	3915/9	Sostegno a forma di L	Sostén en forma de L	L-förmige Stütze	L-shaped support	23,60-
6+7(x2)+12+1+3+2(x2)+36(x2)	3915/10	Serbatoio, asse e dosatore in metallo	Tanque, eje y dosificador de metal	Tank, Achse und Metalldosierer	Tank, axle and metal doser	102,50-



AERARE
AIREAR
VERTIKUTIEREN
SCARIFY



INNESTO
INJERTAR
OKULIEREN
GRAFTING



INOX

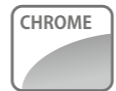

CHROME



TEFLON



LAMA ONDULATA
HOJA ONDULADA
WELLENSCHLIFF
WAVY BLADE



LEGGERO
LIGERO
EXTRA LEICHT
LIGHTWEIGHT



PESO
PESO
GEWICHT
WEIGHT



TAGLIO A BATTENTE
CORTE YUNQUE
AMBOSS SCHERE
ANVIL SHEARS



FORBICE BYPASS
TIJERA BYPASS
BYPASS SCHERE
BYPASS SHEARS



RASTRELLO PER FOGLIAME
RASTRILLO PARA HOJAS
LAUBRECHEN
WIRE RAKE



ACQUA-STOP
AGUA-STOP
WASSERSTOPP
WITH WATER STOPPER



UNIVERSAL



PRODOTTO ECOLOGICO
PRODUCTO ECOLÓGICO
UMWELTFREUNDLICHES PRODUKT
ECO-FRIENDLY PRODUCT



RICAMBI
RECAMBIOS
ERSATZTEILE
SPARE PARTS

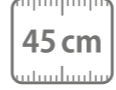

LUNGHEZZA
LONGITUD
LÄNGE
LENGTH



DIAMETRO TAGLIO
DIÁMETRO CORTE
SCHNITT-DURCHMESSER
CUTTING-DIAMETER



GIREVOLE 360°
GIRATORIO 360°
DREHBAR 360°
ROTATING 360°



GIREVOLE 180°
GIRATORIO 180°
DREHBAR 180°
ROTATING 180°



RAGGIO
RADIO
RADIUS
RADIUS



FIBRA DI VETRO
FIBRA DE VIDRIO
FIBERGLAS
FIBERGLASS



MANICO GIREVOLE
MANGO GIRATORIO
ROLLGRIFF
ROTATING HANDLE

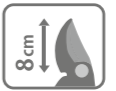

LUNGHEZZA LAMA
LONGITUD HOJA
KLINGENLÄNGE
BLADE LENGTH

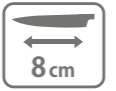

LUNGHEZZA LAMA
LONGITUD HOJA
KLINGENLÄNGE
BLADE LENGTH



DIAMETRO
DIÁMETRO
DURCHMESSER
DIAMETER



ALLUMINIO
ALUMINIO
ALUMINIUM
ALUMINIUM



LAMA CURVA
HOJA CURVADA
GEBogene KLINGE
CURVED BLADE



LUNGHEZZA LAMA
LONGITUD HOJA
KINGENLÄNGE
BLADE LENGTH



MISURA
TALLA
GRÖSSE
SIZE



LAMA CURVA
HOJA CURVADA
GEBogene KLINGE
CURVED BLADE



PROTEZIONE CONTRO IL FREDDO
PROTECCIÓN CONTRA EL FRÍO
FROSTSCHUTZ
WINTER PROTECTION



















TIPO DI GETTO
FORMAS DE CHORRO
SPRÜHFoRM
SPRAY PATTERN















	TIPO DI GETTO FORMAS DE CHORRO SPRÜHFORM SPRAY PATTERN
	AREA ANNAFFIATA MASSIMA MÁXIMA SUPERFICIE IRRIGABLE REICHWEITE RANGE
	AREA DI IRRIGAZIONE MASSIMA MÁXIMA ÁREA DE RIEGO MAXIMALE BEREGNUNGSFLÄCHE MAX. IRRIGATION AREA
	WATERTIMER PROGRAMADOR
	SENZA BATTERIA SIN BATERÍA OHNE BATTERIE WITHOUT BATTERY
	MISURA 1/2" MEDIDA 1/2" GRÖSSE 1/2" SIZE 1/2 INCH
	MISURA 5/8" MEDIDA 5/8" GRÖSSE 5/8" SIZE 5/8 INCH
	MISURA 3/4" MEDIDA 3/4" GRÖSSE 3/4" SIZE 3/4 INCH
	PER 3 MISURE DIFFERENTI TRES MEDIDAS DIFERENTES GRÖSSEN 3X FOR 3 DIFFERENT SIZES
	LARGHEZZA DELL' ATTACCO ANCHO DE LA CONEXIÓN ANSCHLUSSGRÖSSE SIZE OF CONNECTION
	DIAMETRO DIÁMETRO DURCHMESSER DIAMETER
	PRESSIONE PRESIÓN DRUCK PRESSURE
	RIENTRO AUTOMATICO DEL TUBO VUELTA AUTOMÁTICA DEL TUBO AUTOMATISCHER EINZUG RETRACTS THE HOSE AUTOMATICALLY
	TUBO PER IRRIGAZIONE TUBO PARA RIEGO BEWÄSSERUNG IRRIGATION TUBE
	ANTI TOSSICO ANTI TÓXICO NICHT TOXISCH NOT TOXIC
	RIDUZIONE DELLA PRESSIONE REDUCCIÓN DE PRESIÓN DRUCKREDUZIERUNG REDUCTION OF PRESSURE

	ELECTRO
	DURATA BATTERIA DURACIÓN BATERÍA AKKU LAUFZEIT BATTERY RUN-TIME
	LUNGHEZZA DELLA LANCIA LONGITUD LANZA BRAUSENLÄNGE LENGTH OF LANCE
	SERBATOIO DA CAPACIDAD TANQUE FÜLLVOLUMEN FILLING VOLUME
	PEZZI PIEZAS STÜCKZAHL PIECES
	INNESTO V INJERTO V VEREDELUNG V GRAFTING DEVICE V
	ANTI ANNODAMENTO ANTI ENREDAMIENTO ANTI VERKNOTUNG ANTI KNOT
	ANTI TORSIONE ANTI TORCEDURA ANTI VERDREHUNG ANTI TORSION
	5 STRATI 5 ESTRATOS 5 SCHICHTEN 5 LAYERS
	6 STRATI 6 ESTRATOS 6 SCHICHTEN 6 LAYERS
	ORIENTABILE A 180° ORIENTABLE A 180° DREHBAR 180° 180° ADJUSTABLE
	MANICO TELESCOPICO MANGO TELESCÓPICO AUSZIEHBARE GRIFF TELESCOPIC HANDLE
	ATTACCO COMBISYSTEM CONEXIÓN COMBISYSTEM KOMBISYSTEM-ANBINDUNG COMBISYSTEM CONNECTION
	FLUSSO D'ACQUA FLUJO DE AGUA WASSERFLUSS WATER FLOW
	GUARNIZIONI IN FPM JUNTAS EN FPM FPM-DICHTUNGEN FPM SEALS
	DESTRA E SINISTRA DERECHA E IZQUIERDA LINKS UND RECHTS LEFT AND RIGHT

ICONS

















	RUBBER GOMMA GOMA GUMMI RUBBER
	TUBOLARE TUBULAR SCHLAUCHFORMIG TUBULAR
	GRAMMATURA GRAMAJE GRAMMATUR GRAMMAGE
	NON INNAFFIARE NO REGAR NICHT BEGIEßEN DO NOT WATER
	MAGLIA MALLA MASCHENBREITE LINK
	OMBREGGIATURA SOMBRA BESCHATTUNG SHADING
	ANTI TAGLIO ANTI CORTE SCHNITTFEST ANTI CUT
	TOUCHSCREEN
	PELLE CUERO LEDER LEATHER
	IDROREPELENTE REPELENTE AL AGUA WASSERABWEISEND WATER REPELLENT
	ANTI PUNTURA ANTI PUNTERA STICHFEST ANTI-STING
	ASCIA DA TAGLIO HACHA DE CORTE FORSTBEIL CHOPPING AX
	ASCIA DA SPACCO HACHA DE HENDIDURA SPALTAXT SPLITTING AX
	PER ORTO PARA HUERTO FÜR GARTEN FOR VEGETABLE GARDEN
	PER BALCONE PARA BALCON FÜR BALKON FOR BALCONY
	QUANTITÀ VASI NÚMERO DE VASOS MENGE DER TÖPFE AMOUNT OF VASES
	FLUSSO D'ACQUA REGOLABILE LITRI/ORA FLUJO DE AGUA AJUSTABLE EN LITROS/HORA EINSTELLBARER WASSERDURCHFLUSS LITER/STUNDE ADJUSTABLE WATER FLOW LITRES/HOUR
	FLUSSO D'ACQUA LITRI/ORA FLUJO DE AGUA EN LITROS/HORA WASSEFLUSS LITER/STUNDE WATER FLOW LITRES/HOUR
	DUE MODALITÀ DI FUNZIONAMENTO DOS MODOS DE OPERACIÓN ZWEI BETRIEBSMODI TWO OPERATING MODES
	PER DESTROSI E MANCINI PARA DIESTROS Y ZURDOS FÜR LINKS- UND RECHTSHÄNDER FOR RIGHT & LEFT HANDED PEOPLE
	APERTURA REGOLABILE DELLA LAMA APERTURA DE LA HOJA AJUSTABLE INDIVIDUELL ANPASSBARE KLINGENÖFFNUNG CUSTOMIZABLE BLADE'S APERTURE
	TESTA DI TAGLIO SNELLA DELGADA CABEZA DE CORTE SCHLANKER SCHNEIDEKOPF SLIM CUTTING-HEAD
	DIAMETRO DI TAGLIO MAX. DIÁMETRO MÁXIMO DE CORTE MAXIMALER SCHNITTDURCHMESSER MAX. CUTTING DIAMETER
	MODALITÀ DI FUNZIONAMENTO MODO DE OPERACIÓN BETRIEBSMODUS OPERATING MODE
	LARGHEZZA SPRUZZO ANCHO DE PULVERIZACIÓN SPRÜHWEITE SPRAYING WIDTH
	LUNGHEZZA REGOLABILE LONGITUD REGULABLE REGULIERBARE BREITE ADJUSTABLE LENGTH
	GETTO A VENTAGLIO CHORRO A RANGO FLACHSTRAHL-DÜSE FAN-SHAPED JET SPRAY
	2 LIVELLI DI APERTURA REGOLABILE 2 NIVELES DE APERTURA REGULABLE 2 EINSTELLBARE KLINGENÖFFNUNGEN 2 LEVELS OF ADJUSTABLE APERTURE
	PER 3 BATTERIE PARA 3 BATERÍAS FÜR 3 BATTERIEN FOR 3 BATTERIES
	PROFONDITÀ PROFUNDIDAD TIEFE DEPTH
	INTERCAPEDINE PER SCARICO SEGATURA ESPACIO PARA DESCARGA SERRÍN AUSSPARUNGEN FÜR DAS AUSWERFEN VON HOLZSPÄNEN SPACE FOR SAWDUST'S DISCHARGE
	PER LAME PARA HOJAS FÜR KLINGE FOR BLADES



-  PER INGRANAGGI
PARA ENGRANAJES
FÜR GETRIEBE
FOR GEARS
-  2 LANCE INCLUDE
2 LANZAS INCLUIDAS
2 LANZEN INBEGRIFFEN
2 LANCES INCLUDED
-  PER TRATTAMENTI ANTI-ZANZARE
PARA TRATAMIENTOS CONTRA LOS MOSQUITOS
FÜR BEHANDLUNGEN GEGEN STECHMÜCKEN
FOR ANTI-MOSQUITOS TREATMENTS
-  SCHERMO LED BATTERIA E TAGLI
PANTALLA LED BATERÍA Y CORTES
LED-ANZEIGE LADEZUSTAND UND SCHNITTE
LED DISPLAY BATTERY AND CUTS
-  ANGOLO D'IRRIGAZIONE REGOLABILE
ÁNGULO DE RIEGO REGULABLE
REGULIERBARER SPRÜHWINKEL
ADJUSTABLE SPRAYING ANGLE
-  GETTO A SPIRALE
CHORRO EN ESPIRAL
TWIST-SPIRALSTRAHL
TWISTER JET
-  CHIAMATA DI SERVIZIO
-  CONSULTARE IL MANUALE D'USO
CONSULTAR EL MANUAL DEL USUARIO
BEACHTEN SIE DIE BEDIENUNGSANLEITUNG
READ THE USER MANUAL
-  INCLUDE DUE BATTERIE
DOS BATERÍAS INCLUIDAS
ZWEI BATTERIEN INBEGRIFFEN
TWO BATTERIES INCLUDED
-  LARGHEZZA SCANALATURA E PASO
ANCHO DE RANURA Y PASO
NUTBREITE UND KETTENTEILUNG
GROOVE WIDTH AND PITCH
-  MAGMA SYSTEM
-  ESTREMITÀ SUPERIORE ORIENTABILE
EXTREMO SUPERIOR ORIENTABLE
SCHWENKBARER SCHNEIDKOPF
ADJUSTABLE UPPER ENDING PART
-  QUANTITÀ DI TAGLI
CANTIDAD DE CORTES
MENGE DER SCHNITTE
AMOUNT OF CUTS
-  FAST CLICK IN
-  LUNGHEZZA SPRANGA
LONGITUD BARRA
LÄNGE FÜHRUNGSSCHIENE
BAR LENGTH
-  ANTIGRAFFIO
ANTIARAÑAZOS
KRATZFEST
ANTI-SCRATCH

-  ANTIRUMORE
ANTIRRUIDO
GEHÖRSCHUTZ
NOISE PROTECTION
-  TESTA ORIENTABILE FINO A 55° IN VERTICALE
CABEZAL AJUSTABLE VERTICALMENTE HASTA 55°
BIS ZU 55° NEIGBARER SCHNEIDKOPF
55° VERTICALLY ADJUSTABLE HEAD
-  VELOCITÀ DI TAGLIO
VELOCIDAD DE CORTE
SCHNITTGESCHWINDIGKEIT
CUTTING SPEED
-  LAME/CATENE
CUCHILLAS/CADENAS
KLINGEN/KETTEN
BLADES/CHAINS
-  OLIO LUBRIFICANTE
ACEITE LUBRICANTE
SCHMIERÖL
LUBRICATING OIL
-  BIO
-  ROTAZIONE CONICA VERSO L'INTERNO
ROTACIÓN CÓNICA HACIA EL INTERIOR
KONISCHE ROTATIONSRICHTUNG NACH INNEN
INWARD CONICAL ROTATION
-  AMPIEZZA DEL CAMPO DI LAVORO
AMPLITUD DEL CAMPO DE TRABAJO
BREITE DES ARBEITSFELDES
WORKING RANGE
-  RACCOGLIERE FINO A 120 KG/H DI OLIVE
RECOLECTAR HASTA 120 KG/H DE ACEITUNAS
ERNTE VON BIS ZU 120 KG OLIVEN PRO STUNDE
COLLECT UP TO 120 KG/H OF OLIVES
-  SISTEMA DI MISCELAZIONE INTERNO
SISTEMA DE MEZCLA INTERNA
INTERNEN AUTOMATISCHE MISCHUNG
INTERNAL MIXING SYSTEM
-  2 BATTERIE DELLA LINEA POWER 21 V
2 BATERÍAS DE LA LÍNEA POWER 21 V
2 BATTERIEN DER POWER LINE 21 V
2 POWER 21 V BATTERIES
-  BATTERIA NON INCLUSA
BATERÍA NO INCLUIDA
BATTERIE NICHT INBEGRIFFEN
BATTERY NOT INCLUDED
-  BATTERIA E CARICABATTERIE NON INCLUSI
BATERÍA Y CARGADOR NO INCLUIDOS
BATTERIE UND LADEGERÄT NICHT INBEGRIFFEN
BATTERY UND BATTERY CHARGER NOT INCLUDED
-  BATTERIA LI-ION
BATERÍA LI-ION
LI-IONEN-AKKU
LI-ION BATTERY
-  COMPATIBILE CON BATTERIE DELLA LINEA POWER 21 V
COMPATIBLE CON BATERÍAS DE LA LÍNEA POWER 21 V
KOMPATIBEL MIT POWER 21 V BATTERIEN
COMPATIBLE WITH BATTERIES OF THE POWER 21 V LINE

21 V / POWER LINE
stocker

ICONS

-  ERGOMIST
-  LUCE BIANCA
LUZ BLANCA
WEISSES LICHT
WHITE LIGHT
-  TRE REGOLAZIONI DI INTENSITÀ
TRES AJUSTES DE INTENSIDAD
DREI EINSTELLUNGEN
THREE BEAM INTENSITY SETTINGS
-  PORTATA MASSIMA DI 765 M³/H
CAUDAL MÁXIMO DE 765 M³/H
MAXIMALEN LEISTUNG VON 765 M³/H
MAXIMUM FLOW RATE OF 765 M³/H
-  DUE VELOCITÀ DI FUNZIONAMENTO
DOS VELOCIDADES DE FUNCIONAMIENTO
ZWEI BETRIEBSGESCHWINDIGKEITEN
TWO OPERATING SPEEDS
-  FILTRO HEPA
FILTRO HEPA
HEPA-FILTER
HEPA FILTER
-  ASPIRA POLVERI E LIQUIDI
ASPIRA POLVO Y LÍQUIDOS
SAUGT STAUB UND FLÜSSIGKEITEN AUF
VACUUMS UP DUST AND LIQUIDS
-  MODALITÀ SOFFIATORE
MODO SOPLADOR
GEBLÄSEMODUS
BLOWER MODE
-  FILTRO
FILTRO
FILTER
FILTER
-  DIAMETRO
DIÁMETRO
DURCHMESSER
DIAMETER
-  LUNGHEZZA TUBO
LONGITUD DEL TUBO
SCHLAUCHLÄNGE
HOSE LENGTH
-  ASPIRA L'ACQUA O COLLEGA ALLA RETE IDRICA FISSA.
ASPIRA AGUA O CONECTA AL SUMINISTRO DE AGUA FIJO.
ANSAUGEN DURCH SCHLAUCH ODER ANSCHLUSS AN WASSERHAHN.
VACUUM WATER OR CONNECT TO THE FIXED WATER SUPPLY.
-  ANTITAGLIO PER MOTOSEGA
ANTICORTE PARA MOTOSIERRA
SCHNITTFESTE FÜR MOTORSÄGE
ANTI-CUT FOR CHAINSAW
-  GETTO DIRETTO E A VENTAGLIO
CHORRO DIRECTO Y DE ABANICO
STECH- UND FÄCHERSTRAHL
DIRECT AND FAN SPRAY
-  PULIZIA
LIMPIEZA
REINIGUNG
CLEANING
-  SPAZZOLA ROTATIVA
CEPILLO ROTATIVO
ROTIERENDE REINIGUNGSBÜRSTE
ROTARY BRUSH

-  FILTRO ANTISPORCO
FILTRO ANTISUCIEDAD
SCHMUTZFILTER
ANTI-DIRT FILTER
-  FORMULAZIONE 3 IN 1
FORMULACIÓN 3 EN 1
3-IN-1-FORMULIERUNG
3-IN-1 FORMULATION
-  PER LAVAGGIO AUTOMOBILI
PARA LAVADO DE COCHES
FÜR DIE AUTOWÄSCHE
FOR AUTOMOTIVE WASHING

Annotazioni - Anotaciones - Anmerkungen - Notes _____

Art.	EAN	€	pag.
0022	8016604000225	20,90	31
0023	4033119005136	19,05	31
0200	8016604302008	8,20	287
0700	8016604007002	34,40	219
079	8016604183256		264
081	8016604181696		264
090	8016604000904	20,00	62
10001	4033119001473	17,85	268
10001/B	4033119001480	18,65	268
10002	4033119001954	4,35	268
10002/B	4033119001978	6,25	268
10006	4033119004092	1,85	268
10007	4033119002722	27,55	268
1001	4033119001015	16,50	268
1001/BL	4033119001183	17,30	268
1002	4033119001503	3,60	268
1003	4033119002012	3,30	268
1004/04	4033119002029	6,05	268
1004/07	4033119002319	6,05	268
1005	4033119002036	3,00	268
1006	4033119002043	2,00	268
1007	4033119002517	25,95	268
1009	4033119002197	2,00	268
10107	4033119005006	51,90	23
1011	4033119002333	22,35	268
10308	9002683010308	14,60	256
1036	8016604010361	15,70	249
1037	8016604010378	15,70	249
1038	8016604010385	15,70	249
1039	8016604010392	15,70	249
1040	8016604010408	15,70	249
1041	8016604010415	18,10	249
1042	8016604010422	18,10	249
1043	8016604010439	18,10	249
1044	8016604010446	18,10	249
1045	8016604010453	18,10	249
1046	8016604010460	18,10	249
10520	9002683010520	15,80	256
11001	4033119001145	25,30	270
11002	4033119001640	24,60	270
11003	4033119002234	1,40	270
11004/04	4033119002241	20,50	270
11004/07	4033119004108	20,50	270
11005	4033119002258	5,65	270
11006	4033119002265	4,00	270
11007	4033119002586	34,35	270
11008	4033119002272	1,20	270
11009	4033119002289	2,25	270
1104	8016604011047	50,20	20
1105	8016604011054	50,70	20
1107	8016604011078	51,00	20
1109	8016604011092	68,40	20
11100	9002683010315	5,60	256
11104	8016604111044	60,70	28
11107	4033119005013	60,70	28
11109	8016604111099	81,70	28
1117	4033119000858	50,20	29
1127	8016604011276	22,40	177
1127	8016604011276	22,40	253
1128	8016604011283	22,40	177
1128	8016604011283	22,40	253

Art.	EAN	€	pag.	Art.	EAN	€	pag.	Art.	EAN	€	pag.
1129	8016604011290	22,40	177	1247/4	8016604612473	13,50	318				
1129	8016604011290	22,40	253	1247/5	8016604512476	4,35	318				
1130	8016604011306	22,40	177	12500	9002683012500	120,00	256				
1130	8016604011306	22,40	253	12518	8016604125188	24,15	118				
1131	8016604011313	22,40	177	12521	8016604125218	34,50	118				
1131	8016604011313	22,40	253	1254	8016604012549	26,90	125				
1132	8016604011320	22,40	177	12621	8016604126215	31,75	118				
1132	8016604011320	22,40	253	1343	8016604013430	29,20	78				
1133	8016604011337	22,40	177	1345	8016604013454	8,70	85				
1133	8016604011337	22,40	253	1347	8016604013478	6,50	86				
1134	8016604011344	22,40	177	13521	8016604135217	30,50	120				
1134	8016604011344	22,40	253	13524	8016604135248	32,10	120				
1135	8016604011351	22,40	177	13527	8016604135279	33,85	120				
1135	8016604011351	22,40	253	13530	8016604135309	35,45	120				
1136	8016604011368	15,70	249	14	8016604000140		245				
1137	8016604011375	15,70	249	14001	4033119001404	21,55	271				
1138	8016604011382	15,70	249	14002	4033119001909	16,70	271				
1139	8016604011399	15,70	249	14004/04	4033119002494	5,65	271				
1140	8016604011405	15,70	249	14004/07	4033119002500	5,65	271				
1141	8016604011412	18,10	249	14005	4033119004009	5,05	271				
1142	8016604011429	18,10	249	14007	4033119002685	25,80	271				
1143	8016604011436	18,10	249	14008	4033119004016	3,05	271				
1144	8016604011443	18,10	249	14009	4033119004023	1,45	271				
1145	8016604011450	18,10	249	14104	4033119000865	41,80	29				
1146	8016604011467	18,10	249	14107	4033119000872	41,80	29				
11518	8016604115189	20,45	119	1419	8016604014192	22,10	119				
12001	4033119001152	23,85	271	1420	8016604014208	37,20	82				
12002	4033119001657	23,30	271	1420	8016604014208	37,20	120				
12004	4033119002296	21,55	271	14527	8016604145278	35,55	120				
12007	4033119002593	34,00	271	14533	8016604145339	36,70	120				
12104	8016604121043	58,20	28	14627	8016604146275	20,90	120				
12109	8016604121098	71,80	28	15001	4033119001411	21,40	271				
1227	8016604012273	22,40	177	15002	4033119001916	3,85	271				
1227	8016604012273	22,40	253	15007	4033119002692	29,70	271				
1228	8016604012280	22,40	177	15013	4033119004030	13,60	271				
1228	8016604012280	22,40	253	1505	8016604015052	23,10	121				
1229	8016604012297	22,40	177	1506	8016604015069	26,80	121				
1229	8016604012297	22,40	253	1507	8016604015076	24,80	121				
1230	8016604012303	22,40	177	15104	4033119000889	41,80	29				
1230	8016604012303	22,40	253	15107	4033119000896	41,80	29				
1231	8016604012310	22,40	177	15114	4033119005129	41,80	29				
1231	8016604012310	22,40	253	1512	8016604015120	24,80	121				
1232	8016604012327	22,40	177	1513	8016604015137	25,70	121				
1232	8016604012327	22,40	253	1513/1	8016604815133	1,50	280				
1233	8016604012334	22,40	177	1514	8016604015144	26,40	121				
1233	8016604012334	22,40	253	1515	8016604015151	29,00	121				
1234	8016604012341	22,40	177	1601	8016604016011	6,90	175				
1234	8016604012341	22,40	253	1601	8016604016011	6,90	247				
1235	8016604012358	22,40	177	1602	8016604016028	9,50	247				
1235	8016604012358	22,40	253	1603	8016604016035	13,40	247				
1239	8016604012396	184,50	71	1604	8016604016042	6,70	247				
1239/1	8016604912399	70,20	71	1605	8016604016059	8,10	247				
1239/2	8016604812392	10,70	318	1606	8016604016066	9,10	247				
1239/3	8016604712395	8,65	318	1607	8016604016073	6,80	247				
1239/4	8016604612398	21,55	318	1608	8016604016080	10,50	247				
1239/5	8016604512391	8,65	318	1609	8016604016097	7,70	247				
1239/6	8016604412394	4,25	318	1610	8016604016103	6,70	247				
1247	8016604012471	246,00	73	1611	8016604016110	6,70	247				
1247/1	8016604912474	65,90	73	1623	8016604016233	9,00	223				
1247/2	8016604812477	27,10	318	1660	8016604016608	39,60	223				
1247/3	8016604712470	6,75	318	1662	8016604016622	109,50	222				

Art.	EAN	€	pag.	Art.	EAN	€	pag.	Art.	EAN	€	pag.
1663	8016604016639	109,50	222	2004	8016604200564	6,90	160	20520	8016604205200	13,50	187
1664	8016604016646	109,50	222	2007/BL	4033119002524	26,05	268	2054	8016604020544	3,90	186
1665	8016604016653	109,50	222	2008	4033119002050	1,45	268	20540	8016604205408	13,50	187
1668	8016604016684	107,50	222	201	8016604002014	1,60	243	2055	8016604020551	47,35	185
1668/1	8016604916687	0,60	286	20110	8016604201103	2,30	193	2056	8016604020568	3,90	186
1669	8016604016691	107,50	222	20115	8016604201158	1,20	195	20560	8016604205606	13,50	187
1670	8016604016707	107,50	222	2012	8016604200571	7,40	160	2057	8016604020575	19,85	186
1671	8016604016714	107,50	222	20121	8016604201219	1,50	195	2058	8016604582752	8,45	192
1674	8016604016745	122,50	222	20122	8016604201226	2,30	194	2059	8016604020599	17,00	186
1675	8016604016752	122,50	222	20123	8016604201233	2,60	194	206	8016604002069	9,30	245
1676	8016604016769	122,50	222	20124	8016604201240	3,40	194	2060	8016604020605	4,20	194
1677	8016604016776	122,50	222	20125	8016604201257	3,00	194	2062	8016604206290	21,35	193
1821	8016604018213	19,20	177	20126	8016604201264	3,70	194	2063	8016604020636	11,90	195
1821	8016604018213	19,20	253	20127	8016604201271	3,70	194	2064/R	8016604201202	6,90	185
1822	8016604018220	19,20	177	20130	8016604201301	2,40	194	2064/V	8016604201202	6,90	185
1822	8016604018220	19,20	253	2016	8016604020162	10,60	161	2065/B	8016604200755	6,90	185
1823	8016604018237	19,20	177	2018	8016604200496	8,00	160	2065/T	8016604020650	6,85	185
1823	8016604018237	19,20	253	202	8016604002021	1,80	243	2065/V	8016604200755	6,90	185
1824	8016604018244	19,20	177	2020	8016604020209	32,10	163	2066	8016604020667	28,95	185
1824	8016604018244	19,20	253	2021	8016604020216	22,10	163	2067	8016604020674	6,40	186
1825	8016604018251	19,20	177	20210	8016604202100	1,80	193	2067	8016604020674	6,40	286
1825	8016604018251	19,20	253	20212	8016604202124	2,10	193	2068/BO	8016604020681	7,25	185
1826	8016604018268	19,20	177	20215	8016604202155	2,50	193	2068/V	8016604020681	7,25	185
1826	8016604018268	19,20	253	2022	8016604020223	62,50	98	2069	8016604020698	3,00	196
1827	8016604018275	19,20	177	20220	8016604202209	3,25	193	207	8016604002076	4,20	244
1827	8016604018275	19,20	253	20225	8016604202254	4,10	193	2070	8016604020704	4,40	196
1828	8016604018282	19,20	177	2023	8016604020230	60,40	98	2071	8016604020711	49,85	189
1828	8016604018282	19,20	253	20230	8016604202308	4,60	193	2073	8016604020735	2,20	194
1829	8016604018299	19,20	177	20235	8016604202353	5,20	193	2074	8016604586842	2,00	195
1829	8016604018299	19,20	253	2025	8016604020254	63,60	98	2075	8016604020759	46,65	189
1830	8016604018305	19,20	177	20250	8016604202506	5,15	192	2076	8016604207662	7,25	193
1830	8016604018305	19,20	253	2026	8016604020261	7,40	161	2077	8016604020773	50,30	189
1831	8016604018312	19,20	177	2027	8016604020278	8,70	160	2078	8016604207808	7,35	193
1831	8016604018312	19,20	253	2028	8016604020285	25,80	99	2079	8016604020797	4,70	195
1832	8016604018329	19,20	177	2029	8016604020292	17,40	163	208	8016604002083	5,50	244
1832	8016604018329	19,20	253	203	8016604002038	3,40	243	2080	8016604208034	7,35	193
1833	8016604018336	19,20	177	2030	8016604020308	26,80	163	2081	8016604020810	12,00	189
1833	8016604018336	19,20	253	20307	9002683020307	5,00	256	2088	8016604020889	53,60	189
1834	8016604018343	19,20	177	2031	8016604020315	16,80	162	2089	8016604020896	15,90	195
1834	8016604018343	19,20	253	2032	8016604020322	28,50	99	209	8016604002090	7,40	244
1835	8016604918353	35,80	252	2033	8016604020339	15,20	162	2090	8016604020902	63,00	99
1836	8016604918360	35,80	252	2034	8016604020346	15,80	162	2091	8016604020919	61,50	98
1837	8016604918377	35,80	252	2036	8016604200632	7,30	160	2092	8016604020926	74,10	95
1838	8016604918384	35,80	252	2037	8016604200601	7,30	160	2093	8016604020933	21,80	195
1839	8016604918391	35,80	252	2038	8016604201509	8,00	160	2094	8016604020940	74,10	95
1840	8016604918407	35,80	252	2039	8016604020391	39,40	98	210	8016604002106	3,60	245
1841	8016604918414	35,80	252	204	8016604002045	5,20	243	21020	8016604210204	4,00	231
1935	8016604919350	35,80	252	2040	8016604200533	8,80	160	21021	8016604210211	4,00	231
1936	8016604919367	35,80	252	2041	8016604020414	49,90	99	21022	8016604210228	4,00	231
1937	8016604919374	35,80	252	2042	8016604201554	7,30	160	21023	8016604210235	4,00	231
1938	8016604919381	35,80	252	2044	8016604200434	6,90	160	21024	8016604210242	4,00	231
1939	8016604919398	35,80	252	2046	8016604204692	11,20	193	21030	8016604210303	11,95	230
1940	8016604919404	35,80	252	2048	8016604197734	14,80	192	21031	8016604210310	11,95	230
1941	8016604919411	35,80	252	2049	8016604020490	2,60	186	21032	8016604210327	11,95	230
200	8016604002007	1,00	243	205	8016604002052	6,10	243	21033	8016604210334	11,95	230
2000	8016604200557	8,50	160	2050	8016604205064	12,70	193	21034	8016604210341	11,95	230
2001	4033119001039	17,20	268	20500	8016604205002	7,90	192	21038	8016604210389	3,20	209
2001/BL	4033119001190	18,25	268	2051	8016604020513	5,70	195	21039	8016604210396	4,00	209
20015	8016604200151	22,70	98	20510	8016604205101	10,80	195	2104	8016604021046	57,20	21
2002	8016604200519	7,10	160	20512	8016604205125	10,90	195	21043	8016604210433	8,40	218
20025	8016604200250	38,00	98	2052	8016604020520	3,90	186	21045	8016604210457	11,30	217

Art.	EAN	€	pag.	Art.	EAN	€	pag.	Art.	EAN	€	pag.
21047	8016604210471	14,10	217	22032	8016604220326	5,45	231	2215	8016604022159	29,50	162
21049	8016604210495	7,70	218	22033	8016604220333	5,45	231	2216	8016604022166	54,80	162
21050	8016604210501	2,55	237	22034	8016604220340	5,45	231	2217	8016604022173	23,20	162
21051	8016604210518	2,55	237	2204	8016604022043	6,90	161	2218	8016604022180	7,10	162
21052	8016604210525	2,55	237	2205	8016604022050	7,40	161	222	8016604002229	3,80	244
21053	8016604210532	2,35	236	22050	8016604220500	2,05	237	22202	9002683022202	14,80	256
21054	8016604210549	2,35	236	22051	8016604220517	2,05	237	2222	8016604022227	6,25	164
21055	8016604210556	2,35	236	22052	8016604220524	2,05	237	2222	8016604022227	6,25	285
21056	8016604210563	2,55	236	22053	8016604220531	2,35	230	2223	8016604022234	6,00	164
21057	8016604210570	2,55	236	22054	8016604220548	2,35	230	2223	8016604022234	6,00	285
21058	8016604210587	2,55	236	22055	8016604220555	2,35	230	2225	8016604022258	6,45	168
21060	8016604210600	2,55	237	22056	8016604220562	2,75	175	2225	8016604022258	6,45	285
21061	8016604210617	2,55	237	22056	8016604220562	2,75	237	2227	8016604022272	18,10	162
21062	8016604210624	2,55	237	22057	8016604220579	2,75	175	223	8016604002236	4,70	244
2107	8016604021077	58,20	21	22057	8016604220579	2,75	237	224	8016604002243	6,20	244
21074	8016604210747	6,90	235	22058	8016604220586	2,75	175	2247		15,20	166
21075	8016604210754	6,90	235	22058	8016604220586	2,75	237	2248		15,80	165
21076	8016604210761	6,90	235	2206	8016604022067	8,90	161	2249		10,75	168
211	8016604002113	4,40	245	22060	8016604220609	2,05	237	225	8016604002250	144,00	69
21111	8016604211119	18,40	229	22061	8016604220616	2,05	237	2250	8016604022500	21,85	169
21112	8016604211126	18,40	229	22062	8016604220623	2,05	237	2251	8016604022517	19,45	170
21113	8016604211133	18,40	229	22068	8016604220685	5,80	175	2252	8016604022524	14,50	170
21114	8016604211140	18,40	229	22068	8016604220685	5,80	237	2253	8016604022531	21,75	170
21121	8016604211218	4,40	231	22069	8016604220692	5,80	175	2256	8016604022562	20,00	170
21122	8016604211225	4,40	231	22069	8016604220692	5,80	237	2257	8016604022579	17,10	162
21123	8016604211232	4,40	231	2207	8016604022074	10,20	161	2258	8016604022586	29,20	167
21124											

Art.	EAN	€	pag.	Art.	EAN	€	pag.	Art.	EAN	€	pag.
2271	8016604022715	9,45	165	23070	8016604230707	10,50	234	2322	8016604023224	17,10	173
2272	8016604022722	10,65	165	23071	8016604230714	10,50	234	2322	8016604023224	17,10	242
2273	8016604022739	11,55	165	23072	8016604230721	10,50	234	2323	8016604023231	9,20	172
2274	8016604022746	9,25	166	23073	8016604230738	10,50	234	2324	8016604023248	9,20	172
2275	8016604022753	10,20	166	23074	8016604230745	10,50	234	2325	8016604023255	9,20	172
2276	8016604022760	11,80	166	23075	8016604230752	10,50	234	2326	8016604023262	17,10	173
2277	8016604022777	11,10	168	2308	8016604023088		172	2326	8016604023262	17,10	242
2278	8016604022784	5,70	168	23081	8016604230813	5,45	235	2329	8016604023293	17,10	173
2279	8016604022791	16,20	170	23082	8016604230820	5,45	235	2329	8016604023293	17,10	242
228/1	8016604902284	40,50	314	23084	8016604230844	5,45	235	233/1	8016604902338	49,20	334
2281	8016604022814	18,40	162	23085	8016604230851	5,45	235	233/1	8016604902338	49,20	335
2282	8016604022821	8,50	164	23086	8016604230868	5,45	235	233/2	8016604802331	11,70	334
2283	8016604022838	10,20	164	23087	8016604230875	5,45	235	233/2	8016604802331	11,70	335
2284	8016604022845	11,40	164	2309	8016604023095	6,40	172	23308	9002683023308	14,10	256
2285	8016604022852	12,75	164	23090	8016604230905	12,05	233	235/1	8016604902352	50,10	313
2286	8016604022869	13,25	168	23091	8016604230912	12,05	233	235/1	8016604902352	50,10	315
2287	8016604022876	21,05	169	23092	8016604230929	12,05	233	235/2	8016604802355	46,15	313
2288	8016604022883	8,75	166	23093	8016604230936	12,05	233	235/2	8016604802355	46,15	315
2289	8016604022890	9,35	166	231/1	8016604902314	54,10	334	236/1	8016604902369	34,20	313
229	8016604002298	160,50	69	231/1	8016604902314	54,10	335	236/1	8016604902369	34,20	315
2292	8016604022920	12,60	167	231/1	8016604902314	54,10	335	237	8016604002373	119,00	70
2293	8016604022937	13,10	167	231/2	8016604802317	39,70	335	237/1	8016604902376	21,30	317
2297	8016604022975		39	231/2	8016604802317	39,70	335	237/10	8016604802386	9,90	313
2297	8016604022975		41	231/3	8016604702310	12,70	335	237/10	8016604802386	9,90	315
2298	8016604022982		39	231/3	8016604702310	12,70	335	237/10	8016604802386	9,90	317
2298	8016604022982		40	231/4	8016604602313	65,90	334	237/11	8016604702389	2,80	313
2299	8016604022999		39	231/4	8016604602313	65,90	335	237/11	8016604702389	2,80	315
2299	8016604022999		40	231/5	8016604502316	11,30	334	237/11	8016604702389	2,80	316
230	8016604902307	96,40	70	231/5	8016604502316	11,30	335	237/11	8016604702389	2,80	317
230/1	8016604802300	6,60	316	231/6	8016604402319	13,90	335	237/12	8016604602382	34,90	313
230/2	8016604702303	18,50	316	231/6	8016604402319	13,90	335	237/12	8016604602382	34,90	315
2300	8016604023002		39	231/7	8016604302312	4,90	335	237/12	8016604602382	34,90	316
2300	8016604023002		41	231/7	8016604302312	4,90	335	237/12	8016604602382	34,90	317
2301	8016604023019	8,80	172	231/8	8016604202315	6,80	334	237/13	8016604502385	9,10	71
23011	8016604230110	18,25	228	231/8	8016604202315	6,80	335	237/14	8016604402388	13,00	282
23012	8016604230127	18,25	228	231/8	8016604202315	6,80	335	237/14	8016604402388	13,00	315
23013	8016604230134	18,25	228	231/9	8016604102318	11,70	335	237/14	8016604402388	13,00	316
23014	8016604230141	18,25	228	231/9	8016604102318	11,70	335	237/14	8016604402388	13,00	317
2302	8016604023026	8,80	172	2310	8016604023101	6,40	172	237/15	8016604302381	7,30	315
23020	8016604230202	2,75	233	23112	8016604231124	38,30	66	237/15	8016604302381	7,30	316
23021	8016604230219	2,75	233	23112	8016604231124	38,30	226	237/15	8016604302381	7,30	317
23022	8016604230226	2,75	233	23113	8016604231131	38,30	66	237/15	8016604302381	7,30	320
2303	8016604023033	10,70	172	23113	8016604231131	38,30	226	237/17	8016604102387	0,70	284
23032	8016604230325	7,25	230	23114	8016604231148	38,30	66	237/17	8016604102387	0,70	298
23033	8016604230332	7,25	230	23114	8016604231148	38,30	226	237/17	8016604102387	0,70	312
23034	8016604230349	7,25	230	23115	8016604231155	38,30	66	237/17	8016604102387	0,70	313
2304	8016604023040	8,80	172	23115	8016604231155	38,30	226	237/17	8016604102387	0,70	316
23041	8016604230417	10,80	234	2313	8016604023132	3,80	174	237/17	8016604102387	0,70	320
23042	8016604230424	10,80	234	2314	8016604023149	3,80	174	237/18	8016604802393	5,90	284
23043	8016604230431	10,80	234	2315	8016604023156	3,80	174	237/2	8016604802379	4,70	313
23044	8016604230448	10,80	234	2316	8016604023163	37,70	173	237/2	8016604802379	4,70	315
23045	8016604230455	10,80	234	2316	8016604023163	37,70	242	237/2	8016604802379	4,70	316
2305	8016604023057	8,80	172	2318	8016604023187	8,80	172	237/2	8016604802379	4,70	317
23050	8016604230509	7,05	232	232/1	8016604902321	34,70	335	237/2	8016604802379	4,70	320
23051	8016604230516	7,05	232	232/1	8016604902321	34,70	335	237/3	8016604702372	40,10	316
23052	8016604230523	7,05	232	232/2	8016604802324	13,70	335	237/3	8016604702372	40,10	317
23053	8016604230530	7,05	232	232/2	8016604802324	13,70	335	237/4	8016604602375	50,50	316
23054	8016604230547	7,05	232	232/3	8016604702327	9,80	335	237/4	8016604602375	50,50	317
23055	8016604230554	7,05	232	232/3	8016604702327	9,80	335	237/5	8016604502378	2,20	313
2306	8016604023064	10,70	172	2320	8016604023200	10,70	172	237/5	8016604502378	2,20	315
2307	8016604023071	8,20	174	2321	8016604023217	8,80	172	237/5	8016604502378	2,20	316

Art.	EAN	€	pag.	Art.	EAN	€	pag.	Art.	EAN	€	pag.
237/5	8016604502378	2,20	317	242/11	8016604202421	8,00	338	243/21	8016604602436	1,50	333
237/6	8016604402371	8,00	313	242/14	8016604102424	17,10	338	243/21	8016604602436	1,50	336
237/6	8016604402371	8,00	315	242/15	8016604802430	2,60	321	243/21	8016604602436	1,50	337
237/6	8016604402371	8,00	316	242/15	8016604802430	2,60	338	243/22	8016604502439	4,60	331
237/6	8016604402371	8,00	317	242/2	8016604802423	25,00	321	243/22	8016604502439	4,60	332
237/7	8016604302374	3,70	313	242/2	8016604802423	25,00	338	243/22	8016604502439	4,60	333
237/7	8016604302374	3,70	315	242/29	8016604102431	14,10	282	243/22	8016604502439	4,60	336
237/7	8016604302374	3,70	316	242/29	8016604102431	14,10	321	243/22	8016604502439	4,60	337
237/7	8016604302374	3,70	317	242/29	8016604102431	14,10	331	244/1	8016604902444	5,60	334
237/8	8016604202377	6,30	313	242/29	8016604102431	14,10	332	247	8016604002472	203,00	73
237/8	8016604202377	6,30	315	242/29	8016604102431	14,10	333	247/14	8016604902475	18,70	321
237/8	8016604202377	6,30	316	242/29	8016604102431	14,10	338	2470	8016604024702	14,45	165
237/8	8016604202377	6,30	317	242/3	8016604702426	2,10	321	2471	8016604024719	15,35	165
237/9	8016604102370	6,00	313	242/3	8016604702426	2,10	338	2472	8016604024726	16,65	165
237/9	8016604102370	6,00	315	242/30	8016604802485	6,60	282	2473	8016604024733	17,55	165
237/9	8016604102370	6,00	317	242/30	8016604802485	6,60	321	2474	8016604024740	14,95	166
238	8016604002380	127,50	70	242/30	8016604802485	6,60	331	2475	8016604024757	15,95	166
238/1	8016604902383	26,80	317	242/30	8016604802485	6,60	332	2476	8016604024764	17,35	166
239	8016604002397	131,00	70	242/30	8016604802485	6,60	333	2477	8016604024771	16,15	168
239/1	8016604902390	32,20	313	242/30	8016604802485	6,60	338	2478	8016604024788	11,40	168
239/1	8016604902390	32,20	315	242/31	8016604702488	5,50	321	2479	8016604024795	22,50	170
239/1	8016604902390	32,20	317	242/31	8016604702488	5,50	331	248	8016604002489	64,70	124
24	8016604900242		248	242/31	8016604702488	5,50	332	248/1	8016604902482	36,00	332
24011	8016604240119	19,00	228	242/31	8016604702488	5,50	333	248/1	8016604902482	36,00	337
24012	8016604240126	19,00	228	242/31	8016604702488	5,50	338	248/24	8016604402432	9,00	332
24013	8016604240133	19,00	228	242/32	8016604802478	15,90	282	248/24	8016604402432	9,00	333
24014	80										

Art.	EAN	€	pag.	Art.	EAN	€	pag.	Art.	EAN	€	pag.
25040	8016604250408	9,30	141	26034	8016604260346	27,40	151	27208	8016604272080	28,70	147
25040	8016604250408	9,30	147	26067	8016604260674	28,40	154	27210	8016604272103	19,20	146
25045	8016604250453	3,00	142	26084	8016604260841	4,60	154	27213	8016604272134	20,80	146
25045/S	8016604250460	3,00	142	26085	8016604260858	21,85	157	27214	8016604272141	22,30	146
25048	8016604250484	3,10	142	261	8016604002618	40,80	125	27215	8016604272158	23,60	146
25048/S	8016604250491	3,10	142	261/1	8016604902628	4,60	281	27216	8016604272165	24,20	146
25050	8016604250507	2,20	142	261/2	8016604802621	15,90	281	27217	8016604272172	27,50	147
25050/S	8016604250514	2,20	142	261/3	8016604702624	13,10	283	27219	8016604272196	16,40	146
25055	8016604250552	3,10	142	26170	8016604261701	28,10	157	273	4002538640105	11,50	128
25055/S	8016604250545	3,10	142	262/1	8016604602627	8,90	284	274	4002538640136	14,30	128
25056	8016604250569	3,20	142	262/2	8016604502620	7,00	284	275	8016604002755	9,90	128
25056/S	8016604250576	3,20	142	262/3	8016604402623	3,00	284	275/1	8016604902758	4,90	284
25060	8016604250606	36,50	154	26201	8016604262012	17,50	147	278	8016604002786	6,20	128
25062	8016604250620	47,50	154	26202	8016604262029	22,20	147	278/1	8016604902789	4,50	284
25065	8016604250651	3,20	142	26203	8016604262036	31,70	147	28001	8016604280016	70,60	132
25065/S	8016604250668	3,20	142	26209	8016604262098	34,00	147	28002	8016604280023	28,20	135
25070	8016604250705	1,30	140	2621	8016604026218	30,15	72	28003	8016604280030	13,90	137
25070/S	8016604250712	1,30	140	2621/1	8016604926211	24,00	319	28004	8016604280047	9,70	137
25073	8016604250736	2,30	140	2621/2	8016604826214	4,40	319	28004	8016604280047	9,70	157
25073/S	8016604250743	2,30	140	2621/3	8016604726217	2,60	319	28005	8016604280054	1,80	135
25075	8016604250750	2,60	140	26213	8016604262135	23,10	146	28006	8016604280061	2,00	135
25075/S	8016604250767	2,60	140	26214	8016604262142	24,80	147	28007	8016604280078	2,90	135
25080	8016604250804	1,70	140	263	8016604002632	7,30	128	28008	8016604280085	2,60	135
25085	8016604250859	1,30	140	263/1	8016604902635	3,20	284	28009	8016604280092	7,00	135
25090	8016604250903	2,30	140	265	8016604002656	7,70	128	28010	8016604280108	7,50	136
25092	8016604250927	9,30	143	265/1	8016604902659	3,20	284	28011	8016604280115	4,40	136
25094	8016604250941	10,40	140	270	4002538640037	7,40	128	28012	8016604280122	4,00	136
25096	8016604250965	18,80	143	27034	8016604270345	8,20	146	28013	8016604280139	2,20	136
25097	8016604250972	6,60	143	27040	8016604270406	15,00	141	28014	8016604280146	2,10	132
25098	8016604250989	15,90	143	27040	8016604270406	15,00	147	28015	8016604280153	2,40	132
25099	8016604250996	3,30	141	27045	8016604270451	4,90	141	28016	8016604280160	2,70	133
251/46	8016604202612	4,50	321	27045/S	8016604270468	4,90	141	28017	8016604280177	1,90	133
251/46	8016604202612	4,50	338	27046	8016604270437	6,60	141	28018	8016604280184	3,10	133
251/64	8016604302619	10,70	321	27048	8016604270482	5,20	140	28019	8016604280191	3,40	133
251/64	8016604302619	10,70	338	27048/S	8016604270499	5,20	140	28020	8016604280207	3,90	133
25100	8016604251009	3,00	143	27050	8016604270505	4,90	141	28021	8016604280214	3,40	133
25105	8016604251054	4,90	143	27050/S	8016604270512	4,90	141	28022	8016604280221	3,80	134
252/30	8016604502521	7,30	338	27069	8016604270697	92,70	156	28023	8016604280238	5,90	136
252/35	8016604202575	66,60	321	27070	8016604270703	31,45	156	28024	8016604280245	2,20	134
252/35	8016604202575	66,60	338	27071	8016604270710	59,30	156	28025	8016604280252	2,20	136
252/40	8016604402531	2,90	321	27072	8016604270727	58,50	156	28026	8016604280269	1,70	134
252/40	8016604402531	2,90	338	27073	8016604270734	109,50	156	28027	8016604280276	8,50	137
25211	8016604252112	8,90	146	27074	8016604270741	23,80	156	28028	8016604280283	16,70	137
25212	8016604252129	9,90	146	27075	8016604270758	39,65	156	28029	8016604280290	2,90	137
2535	8016604025358	35,80	252	27076	8016604270765	74,70	156	281	8016604002816	7,00	128
2536	8016604025365	35,80	252	27077	8016604270772	37,70	156	2821	8016604028212	19,20	177
2537	8016604025372	35,80	252	27078	8016604270789	71,00	156	2822	8016604028229	19,20	177
2538	8016604025389	35,80	252	27079	8016604270796	70,40	156	2822	8016604028229	19,20	253
2539	8016604025396	35,80	252	27080	8016604270802	131,50	156	2823	8016604028236	19,20	177
254	8016604002540	30,90	125	27081	8016604270819	29,65	156	2823	8016604028236	19,20	253
2540	8016604025402	35,80	252	27082	8016604270826	49,65	156	2824	8016604028243	19,20	177
2541	8016604025419	35,80	252	27083	8016604270833	93,70	156	2824	8016604028243	19,20	253
255	8016604002557	37,20	125	27084	8016604270840	13,55	156	2825	8016604028250	19,20	177
256	8016604002564	35,10	125	27085	8016604270857	22,55	156	2825	8016604028250	19,20	253
257/30	8016604302589	6,40	321	27086	8016604270864	15,25	156	2826	8016604028267	19,20	177
260/11	8016604202605	8,60	282	27087	8016604270871	25,30	156	2826	8016604028267	19,20	253
260/12	8016604102608	14,40	282	27088	8016604270888	59,10	156	2827	8016604028274	19,20	177
26010	8016604260100	32,20	151	271	4002538640051	7,90	128	2827	8016604028274	19,20	253
26015	8016604260155	65,40	152	272	4002538640082	10,10	128	2828	8016604028281	19,20	177
26021	8016604260216	9,00	150	27207	8016604272073	26,00	147				
26031	8016604260315	53,60	151								

Art.	EAN	€	pag.	Art.	EAN	€	pag.	Art.	EAN	€	pag.	Art.	EAN	€	pag.
2828	8016604028281	19,20	253	301/16	8016604303029	5,50	325	306	8016604003066	18,90	126				
2829	8016604028298	19,20	177	301/17	8016604203022	2,95	323	306/1	8016604902987	1,60	284				
2829	8016604028298	19,20	253	301/17	8016604203022	2,95	325	306/2	8016604802980	8,30	284				
283	8016604002830	11,30	128	301/18	8016604103025	3,90	323	307	8016604003073	84,00	41				
283/1	8016604902833	4,90	284	301/18	8016604103025	3,90	325	307	8016604003073	84,00	126				
2830	8016604028304	19,20	177	301/19	8016604903038	7,45	323	307/1	8016604703256	12,65	284				
2830	8016604028304	19,20	253	301/19	8016604903038	7,45	325	307/2	8016604603259	2,25	284				
2831	8016604028311	19,20	177	301/2	8016604803017	6,05	323	308	8016604003080	43,40	129				
2831	8016604028311	19,20	253	301/2	8016604803017	6,05	325	308/1	8016604903083	9,50	340				
2832	8016604028328	19,20	177	301/20	8016604803031	45,40	323	308/2	8016604803086	8,30	340				
2832	8016604028328	19,20	253	301/21	8016604703034	7,10	323	308/3	8016604703089	11,90	340				
2833	8016604028335	19,20	177	301/21	8016604703034	7,10	325	308/4	8016604603082	8,10	340				
2833	8016604028335	19,20	253	301/22	8016604603037	40,75	323	308/5	8016604503085	17,90	340				
2834	8016604028342	19,20	177	301/22	8016604603037	40,75	325	308/6	8016604403088	3,80	340				
2834	8016604028342	19,20	253	301/23	8016604503030	2,70	323	308/7	8016604303081	5,50	340				
2835	8016604028359	19,20	177	301/23	8016604503030	2,70	325	309	8016604003097	145,00	59				
2835	8016604028359	19,20	253	301/24	8016604403033	10,40	323	309/1	8016604903090	5,00	308				
285	8016604002854	14,00	128	301/25	8016604303036	2,70	323	309/1	8016604903090	5,00	309				
285/1	8016604902857	4,90	284	301/25	8016604303036	2,70	325	309/10	8016604503061	40,75	309				
288	8016604002885	9,50	128	301/26	8016604903045	10,30	323	309/11	8016604403064	1,75	308				
2899	8016604028991	5,20	127	301/27	8016604903250	9,75	323	309/11	8016604403064	1,75	309				
2900	8016604029004	3,10	126	301/27	8016604903250	9,75	325	309/12	8016604303067	13,50	309				
2901	8016604029011	2,10	127	301/3	8016604703010	32,05	323	309/13	8016604203060	2,40	308				
2902	8016604029028	1,80	127	301/4	8016604603013	63,10	323	309/13	8016604203060	2,40	309				
2903	8016604029035	5,20	127	301/5	8016604503016	64,50	323	309/14	8016604103063	3,35	309				
2904	8016604029042	1,50	127	301/6	8										

Art.	EAN	€	pag.	Art.	EAN	€	pag.	Art.	EAN	€	pag.
310/6	8016604403101	1,80	297	312/7	8016604203091	588,00	295	315/6	8016604403163	4,75	304
310/6	8016604403101	1,80	305	312/7	8016604203091	588,00	296	315/7	8016604303166	96,30	304
310/6	8016604403101	1,80	306	312/7	8016604203091	588,00	297	315/8	8016604203169	31,50	304
310/7	8016604903137	64,90	305	312/7	8016604203091	588,00	298	315/9	8016604103162	157,50	304
310/7	8016604903137	64,90	306	312/7	8016604203091	588,00	299	316/1	8016604303197	16,50	294
310/8	8016604203107	23,45	305	312/7	8016604203091	588,00	300	316/10	8016604303203	46,00	292
310/8	8016604203107	23,45	306	312/7	8016604203091	588,00	301	316/10	8016604303203	46,00	293
310/9	8016604103100	126,00	306	312/7	8016604203091	588,00	302	316/10	8016604303203	46,00	294
31001	4033119310018	28,55	271	312/7	8016604203091	588,00	303	316/11	8016604303210	2,10	292
31002	4033119310025	33,95	271	312/8	8016604103094	108,20	40	316/11	8016604303210	2,10	293
31006	9002683031006	324,00	257	312/8	8016604103094	108,20	41	316/11	8016604303210	2,10	294
31008	4033119310087	11,25	271	312/8	8016604103094	108,20	41	316/11	8016604303210	2,10	295
31040	4033119310407	72,90	30	312/8	8016604103094	108,20	54	316/12	8016604103209	6,65	294
31050	4033119310506	77,50	30	312/8	8016604103094	108,20	288	316/13	8016604903212	2,90	294
31060	4033119310605	81,70	30	312/8	8016604103094	108,20	290	316/14	8016604803215	1,35	294
311	8016604003110	366,00	56	312/8	8016604103094	108,20	291	316/15	8016604703218	92,00	294
311/1	8016604803130	9,35	305	312/8	8016604103094	108,20	292	316/16	8016604603211	2,25	294
311/10	8016604303128	12,25	305	312/8	8016604103094	108,20	293	316/17	8016604503214	5,00	294
311/11	8016604203121	1,80	305	312/8	8016604103094	108,20	294	316/18	8016604403217	22,00	294
311/12	8016604103124	14,40	305	312/8	8016604103094	108,20	295	316/19	8016604803222	8,75	294
311/13	8016604703133	33,35	305	312/8	8016604103094	108,20	296	316/2	8016604203190	10,00	294
311/2	8016604203114	21,65	305	312/8	8016604103094	108,20	297	316/3	8016604103193	14,80	294
311/3	8016604103117	15,30	305	312/8	8016604103094	108,20	298	316/4	8016604903205	4,00	293
311/4	8016604903120	12,45	305	312/8	8016604103094	108,20	299	316/4	8016604903205	4,00	294
311/5	8016604803123	5,40	305	312/8	8016604103094	108,20	300	316/5	8016604803208	3,15	294
311/6	8016604703126	169,50	305	312/8	8016604103094	108,20	301	316/6	8016604703201	1,65	294
311/7	8016604603129	90,10	305	312/8	8016604103094	108,20	302	316/7	8016604603204	1,25	292
311/8	8016604503122	5,75	305	312/8	8016604103094	108,20	303	316/7	8016604603204	1,25	293
311/9	8016604403125	1,20	305	312/9	8016604203084	145,50	288	316/7	8016604603204	1,25	294
312/1	8016604703096	14,25	288	313	8016604003134	628,00	58	316/7	8016604603204	1,25	295
312/1	8016604703096	14,25	296	313/1	8016604103131	9,25	307	316/8	8016604503207	2,10	292
312/1	8016604703096	14,25	297	313/10	8016604603143	1,20	307	316/8	8016604503207	2,10	293
312/10	8016604103087	92,00	288	313/11	8016604503146	4,05	307	316/8	8016604503207	2,10	294
312/11	8016604903076	5,75	288	313/12	8016604403149	1,30	307	316/8	8016604503207	2,10	295
312/11	8016604903076	5,75	290	313/13	8016604303142	4,20	307	316/9	8016604403200	9,15	292
312/11	8016604903076	5,75	291	313/14	8016604203145	28,00	307	316/9	8016604403200	9,15	293
312/11	8016604903076	5,75	301	313/15	8016604103148	48,55	307	316/9	8016604403200	9,15	294
312/11	8016604903076	5,75	302	313/16	8016604903151	1,80	307	316/9	8016604403200	9,15	295
312/12	8016604803079	16,05	288	313/17	8016604803154	28,00	307	317/1	8016604303173	19,15	293
312/13	8016604703072	19,65	288	313/18	8016604703157	59,50	307	317/1	8016604303173	19,15	294
312/14	8016604603075	5,75	288	313/19	8016604603150	3,30	307	317/1	8016604303173	19,15	310
312/15	8016604503078	22,55	288	313/2	8016604203138	30,50	307	317/2	8016604203176	13,05	293
312/17	8016604103216	9,00	272	313/3	8016604303135	22,75	307	317/2	8016604203176	13,05	294
312/2	8016604603099	29,55	288	313/4	8016604403132	12,40	307	317/2	8016604203176	13,05	310
312/2	8016604603099	29,55	296	313/5	8016604503139	5,40	307	317/3	8016604103179	1,55	293
312/2	8016604603099	29,55	297	313/6	8016604603136	261,00	307	317/3	8016604103179	1,55	294
312/3	8016604503092	17,85	288	313/7	8016604703140	15,05	307	317/4	8016604903182	2,50	293
312/3	8016604503092	17,85	296	313/8	8016604803147	35,00	307	317/4	8016604903182	2,50	294
312/3	8016604503092	17,85	297	313/9	8016604903144	350,00	307	317/4	8016604903182	2,50	310
312/4	8016604403095	19,85	288	314	8016604003141	207,00	57	318/1	8016604803185	22,60	292
312/5	8016604303098	5,40	288	315	8016604003158	464,00	56	318/10	8016604803192	128,00	292
312/7	8016604203091	588,00	40	315/1	8016604903168	13,90	304	318/11	8016604703195	3,00	292
312/7	8016604203091	588,00	40	315/10	8016604903175	66,50	304	318/12	8016604603198	12,75	292
312/7	8016604203091	588,00	41	315/11	8016604803178	20,65	304	318/13	8016604503191	5,00	292
312/7	8016604203091	588,00	54	315/12	8016604703171	21,00	304	318/14	8016604403194	25,65	292
312/7	8016604203091	588,00	288	315/13	8016604603174	5,60	304	318/15	8016604703225	8,75	292
312/7	8016604203091	588,00	290	315/14	8016604503177	31,50	304	318/2	8016604703188	16,65	292
312/7	8016604203091	588,00	291	315/2	8016604803161	31,15	304	318/3	8016604603181	20,55	292
312/7	8016604203091	588,00	292	315/3	8016604703164	19,10	304	318/4	8016604503184	4,00	292
312/7	8016604203091	588,00	293	315/4	8016604603167	21,00	304	318/5	8016604403187	8,35	292
312/7	8016604203091	588,00	294	315/5	8016604503160	5,25	304	318/6	8016604303180	2,70	292

Art.	EAN	€	pag.	Art.	EAN	€	pag.	Art.	EAN	€	pag.	Art.	EAN	€	pag.
318/7	8016604203183	6,70	292	325	8016604003257	944,00	54	3436	8016604034367	16,20	250				
318/8	8016604103186	2,10	292	325	8016604003257	944,00	288	3437	8016604034374	16,20	250				
318/8	8016604103186	2,10	293	325	8016604003257	944,00	290	3438	8016604034381	16,20	250				
318/8	8016604103186	2,10	295	325	8016604003257	944,00	291	3439	8016604034398	16,20	250				
318/9	8016604903199	13,50	292	325	8016604003257	944,00	292	344	8016604472053	15,70	83				
32	8016604000324		261	325	8016604003257	944,00	293	3440	8016604034404	16,20	250				
320	8016604003202	142,00	61	325	8016604003257	944,00	294	3441	8016604034411	19,80	250				
320/1	8016604603228	12,35	311	325	8016604003257	944,00	295	3442	8016604034428	19,80	250				
320/10	8016604503238	1,65	310	325	8016604003257	944,00	296	3443	8016604034435	19,80	250				
320/10	8016604503238	1,65	311	325	8016604003257	944,00	297	3444	8016604034442	19,80	250				
320/11	8016604403231	1,05	310	325	8016604003257	944,00	298	3445	8016604034459	19,80	250				
320/11	8016604403231	1,05	311	325	8016604003257	944,00	299	3446	8016604034466	19,80	250				
320/12	8016604303234	26,25	311	325	8016604003257	944,00	300	345	8016604407222	8,80	85				
320/14	8016604103230	1,40	311	325	8016604003257	944,00	301	34520	8016604345203	10,00	83				
320/15	8016604903243	3,25	310	325	8016604003257	944,00	302	34525	8016604345258	10,00	83				
320/15	8016604903243	3,25	311	325	8016604003257	944,00	303	346	8016604003462	9,20	84				
320/16	8016604803246	4,85	310	326	8016604003264	126,00	40	34620	8016604346200	10,50	83				
320/16	8016604803246	4,85	311	326	8016604003264	126,00	54	34625	8016604346255	10,50	83				
320/17	8016604703249	2,30	311	32706	9002683032706	4,00	258	347	8016604003479	6,50	86				
320/18	8016604603242	1,55	311	328	8016604003288	406,00	40	348	8016604003486	9,20	85				
320/2	8016604503221	8,45	311	328	8016604003288	406,00	41	349	8016604003493	12,00	84				
320/3	8016604403224	7,00	311	328	8016604003288	406,00	54	35	8016604000355		262				
320/4	8016604303227	1,25	311	328	8016604003288	406,00	288	350	8016604003509	28,50	78				
320/5	8016604503245	3,45	310	328	8016604003288	406,00	290	3501	8016604035012	18,90	259				
320/5	8016604503245	3,45	311	328	8016604003288	406,00	291	3502	801660						

Art.	EAN	€	pag.	Art.	EAN	€	pag.	Art.	EAN	€	pag.
3732	8016604037320	14,40	176	3916	8016604039164	57,90	239	410/14	8016604804120	2,30	298
3732	8016604037320	14,40	251	392	8016604003929	11,00	83	41005	9002683041005	20,40	258
3734	8016604037344	14,40	176	393	8016604003936	11,00	83	414/8	8016604204142	4,15	298
3734	8016604037344	14,40	251	40	8016604000409		263	416	8016604004162	11,80	88
374	8016604003745	8,70	84	401	8016604004018	62,70	72	417	8016604004179	15,50	88
376	8016604003769	47,40	80	401/1	8016604904011	15,00	320	418	8016604004186	12,00	88
377	8016604003776	44,95	80	401/10	8016604204012	6,50	320	42	8016604000423		263
378	8016604003783	47,40	80	401/11	8016604604119	4,80	320	420/3	8016604504204	2,85	319
379	8016604003790	44,95	80	401/12	8016604504112	11,40	320	42002	9002683042002	10,30	259
38	8016604000386		262	401/13	8016604404115	5,40	320	421	8016604004216	25,40	89
380	8016604003806	42,65	81	401/3	8016604704017	9,10	320	421	8016604004216	25,40	197
381	8016604003813	45,30	81	401/4	8016604604010	7,70	320	422	8016604004223	15,80	89
382	8016604003820	18,00	79	401/5	8016604504013	9,30	320	422	8016604004223	15,80	197
3826	8016604038266	14,40	176	401/6	8016604104015	9,50	320	423	8016604004230	35,80	71
3826	8016604038266	14,40	251	401/7	8016604704116	2,60	320	423	8016604004230	35,80	314
3828	8016604038280	14,40	176	401/8	8016604404016	3,10	320	423/1	8016604904233	2,90	312
3828	8016604038280	14,40	251	401/9	8016604304019	13,70	320	423/1	8016604904233	2,90	314
383	8016604003837	40,65	81	402	8016604004025	66,70	72	423/2	8016604804236	6,20	312
3830	8016604038303	14,40	176	402/1	8016604904028	19,70	320	423/2	8016604804236	6,20	314
3830	8016604038303	14,40	251	403	8016604004032	228,00	68	424	8016604004247	36,85	71
3832	8016604038327	14,40	176	403/1	8016604904035	37,00	312	424	8016604004247	36,85	312
3832	8016604038327	14,40	251	403/10	8016604604027	0,70	312	424	8016604004247	36,85	314
3834	8016604038341	14,40	176	403/2	8016604804038	68,30	312	425	8016604004254	37,50	71
3834	8016604038341	14,40	251	403/3	8016604704031	32,30	312	425	8016604004254	37,50	314
384	8016604003844	17,50	79	403/4	8016604604034	20,10	312	426	8016604004261	14,25	64
386	8016604003868	19,60	79	403/5	8016604504037	37,00	312	426	8016604004261	14,25	88
39	8016604000393		265	403/6	8016604404030	16,50	312	427	8016604004278	12,85	64
3902	8016604039010	22,60	239	403/7	8016604304033	14,60	312	428	8016604004285	16,40	89
3906	8016604039065	158,50	238	403/8	8016604204036	3,10	312	428	8016604004285	16,40	197
3907	8016604039072	171,50	238	403/9	8016604104039	16,40	312	429	8016604004292	15,40	64
3909	8016604039096	106,50	99	404	8016604004049	768,00	40	429	8016604004292	15,40	88
3914	8016604039140	122,00	238	404	8016604004049	768,00	49	43	8016604000430		236
3914/1		31,10	344	404/1	8016604304040	26,35	298	430	8016604004308	40,90	64
3914/10		43,20	344	404/10	8016604704055	15,25	298	4300		1,40	258
3914/11		6,00	344	404/10	8016604704055	15,25	313	43009	9002683043009	13,00	259
3914/12		30,80	344	404/11	8016604604058	19,00	298	4301		1,40	258
3914/13		5,50	344	404/11	8016604604058	19,00	313	4305		0,60	259
3914/14		30,40	344	404/12	8016604504051	7,65	298	431	8016604004315	54,80	65
3914/15		1,10	344	404/13	8016604404054	14,30	298	431	8016604004315	54,80	89
3914/16		3,30	344	404/14	8016604304057	12,40	281	433	8016604004339	554,40	41
3914/17		10,00	344	404/14	8016604304057	12,40	298	433	8016604004339	554,40	51
3914/18		11,20	344	404/14	8016604304057	12,40	313	433/1	8016604604331	8,60	299
3914/2		3,80	344	404/15	8016604204050	16,25	298	433/1	8016604604331	8,60	300
3914/3		4,80	344	404/16	8016604104053	4,75	298	433/2	8016604504334	12,25	51
3914/4		1,50	344	404/2	8016604104046	37,65	298	433/2	8016604504334	12,25	300
3914/5		6,10	344	404/3	8016604504044	48,45	298	433/3	8016604404337	23,35	300
3914/6		11,80	344	404/4	8016604404047	19,00	298	433/4	8016604304330	9,70	300
3914/7		25,60	344	404/5	8016604704048	19,55	298	433/5	8016604204333	5,20	300
3914/8		22,10	344	404/6	8016604604041	3,05	298	433/6	8016604104336	71,30	300
3914/9		43,20	344	404/7	8016604804045	10,70	298	433/7	8016604904318	5,15	300
3915	8016604039157	156,50	238	404/8	8016604904042	8,15	298	433/8	8016604804311	2,85	300
3915/1		20,00	345	404/9	8016604204043	8,50	298	433/9	8016604704314	3,40	300
3915/10	8016604939150	102,50	345	405	8016604004056	796,00	40	434	8016604004346	528,00	41
3915/2		3,90	345	405	8016604004056	796,00	48	434	8016604004346	528,00	41
3915/3		4,80	345	405/1	8016604904059	28,55	298	434	8016604004346	528,00	50
3915/4		4,10	345	405/2	8016604804052	39,10	298	434/1	8016604904349	23,30	51
3915/5		45,50	345	406	8016604004063	852,00	40	434/1	8016604904349	23,30	299
3915/6		45,50	345	406	8016604004063	852,00	48	434/10	8016604604317	20,65	299
3915/7		25,30	345	406/1	8016604904066	31,70	298	434/11	8016604504310	16,75	299
3915/8		12,60	345	406/2	8016604804069	41,05	298	434/12	8016604404313	115,00	299
3915/9		23,60	345	41	8016604000416		263	434/13	8016604304316	2,65	299

Art.	EAN	€	pag.	Art.	EAN	€	pag.	Art.	EAN	€	pag.
434/2	8016604804342	11,70	299	4524	8016604045240	282,00	202	4612	8016604046124	1,95	208
434/3	8016604704345	35,80	299	4525	8016604045257	217,00	203	4620	8016604046209	96,30	196
434/4	8016604604348	10,60	299	4526	8016604045264	24,40	216	4638	8016604046384	6,60	217
434/5	8016604504341	3,80	299	4528	8016604045288	20,30	216	4640	8016604046407	18,60	196
434/6	8016604404344	4,80	299	4535	8016604295720	13,90	217	4650	8016604046506	3,00	208
434/7	8016604304347	5,45	299	4536	8016604693762	8,50	217	4652	8016604046520	6,60	208
434/8	8016604204340	10,55	299	4538	8016604045387	19,10	216	4653	8016604046537	9,40	208
434/9	8016604104343	2,90	299	4539	8016604045394	9,80	216	4654	8016604046544	12,10	208
435	8016604004353	22,50	41	4541	8016604045417	412,00	202	4655	8016604046551	12,90	205
435	8016604004353	22,50	50	4542	8016604200465	0,60	243	4659	8016604046599	381,00	206
44	8016604000447		114	4543	8016604200618	1,00	243	4663	8016604046636	22,30	206
4409	8016604044090	20,30	246	4544	8016604200441	1,20	243	4664	8016604046643	34,60	206
4410	8016604044106	5,90	246	4545	8016604200380	2,00	243	4670	8016604046704	23,00	197
44107	8016604441073	4,50	217	4546	8016604045462	198,50	202	4675	8016604046759	2,40	197
44108	8016604441080	5,80	217	4548	8016604045486	262,00	202	4679	8016604046797	277,00	208
4411	8016604044113	14,00	246	4549	8016604200373	2,80	243	4680	8016604046803	352,00	208
4415	8016604044151	45,40	175	45500	8016604455001	4,70	243	4681		111,50	207
4415	8016604044151	45,40	246	45501	8016604455018	5,20	243	4684	8016604046841	20,40	205
4416	8016604044168	28,00	246	45502	8016604455025	7,00	243	4685	8016604046858	20,40	205
4417	8016604044175	39,20	246	45504	8016604455049	1,80	244	4689	8016604046896	10,20	205
4418	8016604044182	39,20	246	45505	8016604455056	1,60	244	4690	8016604046902	5,40	205
4419	8016604044199	30,80	246	45506	8016604455063	5,10	244	4691	8016604046919	6,60	205
4468	8016604044687	4,10	201	4551	8016604200359	3,80	243	4692	8016604046926	11,20	205
4470	8016604044700	7,20	201	4553	8016604045530	24,30	205	4693	8016604046933	13,60	205
4500	8016604112232	7,00	200	4555	8016604045554	354,00	206	4694	8016604046940	14,90	205
4501	8016604440014	8,70	200	4558	8016604045585	214,00	202	4695	8016604046957	2,20	196
4502	8016604832055	4,80	200	4560	8016604045608	142,00	206	4696	8016604046964	4,40	196
4503	8016604045035	5,50	200	4561	8016604045615	284,00	206	4697	8016604046971	3,50	196
4504	8016604045042	99,10	202	4562	8016604045622	43,30	202	4698	8016604046988	3,50	196

Art.	EAN	€	pag.	Art.	EAN	€	pag.	Art.	EAN	€	pag.
4794	8016604047947	1,70	243	5107	4033119000650	39,55	22	566	8016604005664	49,80	108
4795	8016604047954	1,80	243	5109	8016604051098	52,90	22	567	8016604005671	56,60	108
4796	8016604047961	2,20	243	511	8016604005121	38,95	112	568	8016604005688	47,60	110
48	8016604000485		263	511/1	8016604905117	6,20	330	569	8016604005695	55,10	110
4860	8016604948602	6,70	207	511/1	8016604905117	6,20	330	570	8016604005701	62,10	110
4861	8016604048616	9,30	207	511/1	8016604905117	6,20	330	571	8016604005718	79,40	112
4862	8016604948626	8,30	207	511/2	8016604805110	10,40	330	572	8016604005725	85,60	112
4863	8016604048630	12,50	207	511/3	8016604705113	13,05	330	573	8016604005732	91,50	112
4864	8016604048647	30,10	207	511/3	8016604705113	13,05	330	574	8016604005749	84,70	113
4865	8016604048654	75,30	207	511/3	8016604705113	13,05	330	575	8016604005756	90,80	113
4866	8016604048661	53,70	207	5127	8016604051272	45,00	22	576	8016604005763	96,80	113
4867	8016604048678	132,00	207	514	8016604005145	30,20	114	577	8016604005770	83,80	111
4902	4012007341075	152,00	241	515	8016604005152	37,30	114	578	8016604005787	90,10	111
4905	4012007168054	211,00	241	518	8016604005183	44,20	113	579	8016604005794	96,00	111
491	8016604004919	13,70	88	518/1	8016604905186	30,30	330	580	8016604005800	184,00	42
491	8016604004919	13,70	197	518/2	8016604805189	10,40	330	580/1	8016604905803	58,20	289
4910	8016604049101	7,50	239	518/2	8016604805189	10,40	330	580/10	8016604905810	8,20	289
4913	8016604049132	6,90	173	518/3	8016604705182	12,30	330	580/11	8016604805813	6,75	289
4913	8016604049132	6,90	242	518/3	8016604705182	12,30	330	580/11	8016604805813	6,75	297
4914	8016604049149	12,00	173	52	8016604000522		236	580/11	8016604805813	6,75	297
4914	8016604049149	12,00	242	523	8016604005237	43,50	111	580/12	8016604705816	5,80	289
4915	8016604049156	6,90	173	523/1	8016604905230	29,55	330	580/12	8016604705816	5,80	296
4915	8016604049156	6,90	242	524	8016604005244	35,00	115	580/12	8016604705816	5,80	297
4916	8016604049163	12,00	173	527	8016604005275	67,30	115	580/13	8016604605819	5,80	289
4916	8016604049163	12,00	242	530	8016604005305	54,70	109	580/14	8016604205811	11,15	289
4919	8016604049194	5,40	173	533	8016604005336	47,00	109	580/14	8016604205811	11,15	295
4919	8016604049194	5,40	242	534	8016604005343	43,60	109	580/14	8016604205811	11,15	296
492	8016604004926	12,10	88	535	8016604005350	37,00	109	580/14	8016604205811	11,15	297
492	8016604004926	12,10	197	536	8016604005367	44,90	109	580/2	8016604805806	27,30	289
4920	8016604049200	5,40	173	559	8016604005596	38,00	110	580/3	8016604705809	20,95	289
4920	8016604049200	5,40	242	559/1	8016604905599	7,20	329	580/4	8016604605802	1,65	289
4924	8016604049248	12,00	173	559/1	8016604905599	7,20	329	580/4	8016604605802	1,65	296
4924	8016604049248	12,00	242	559/2	8016604805592	3,00	289	580/5	8016604505805	24,60	289
4925	8016604049255	5,40	173	559/2	8016604805592	3,00	295	580/5	8016604505805	24,60	296
4925	8016604049255	5,40	242	559/2	8016604805592	3,00	296	580/5	8016604505805	24,60	297
4926	8016604049262	6,90	173	559/2	8016604805592	3,00	308	580/6	8016604405808	8,20	289
4926	8016604049262	6,90	242	559/2	8016604805592	3,00	329	580/6	8016604405808	8,20	295
4927	8016604049279	6,00	173	559/2	8016604805592	3,00	329	580/6	8016604405808	8,20	296
4927	8016604049279	6,00	242	559/2	8016604805592	3,00	329	580/6	8016604405808	8,20	297
4928	8016604049286	6,00	173	559/3	8016604705595	5,60	329	580/7	8016604305801	4,00	289
4928	8016604049286	6,00	242	559/4	8016604605598	3,00	329	580/8	8016604205804	33,10	289
5001	4033119001381	14,95	268	559/4	8016604605598	3,00	329	580/9	8016604105807	10,40	289
5001/BL	4033119001220	15,70	268	559/4	8016604605598	3,00	329	581	8016604005817	215,00	42
5002	4033119001558	3,85	269	559/5	8016604505591	1,20	329	581/1	8016604505812	77,40	289
5003	4033119002128	3,05	269	559/5	8016604505591	1,20	329	581/1	8016604505812	77,40	296
5004	4033119002203	5,05	269	560	8016604005602	43,80	110	581/2	8016604405815	31,90	289
5005	4033119002135	2,35	269	561	8016604005619	52,70	110	581/2	8016604405815	31,90	296
5007	4033119002548	24,25	269	565	8016604005657	42,90	108	581/3	8016604305818	24,25	289
5009	4033119002210	1,90	269	565/1	8016604905650	8,90	329	581/3	8016604305818	24,25	296
502	8016604005022	47,50	104	565/2	8016604805653	3,00	289	584	8016604005848	219,00	40
50205	9002683050205	76,20	257	565/2	8016604805653	3,00	295	584	8016604005848	219,00	42
5021	4033119001282	17,20	269	565/2	8016604805653	3,00	296	584/1	8016604905841	22,50	289
5022	4033119001763	4,00	269	565/2	8016604805653	3,00	308	584/2	8016604805844	38,65	289
5027	4033119002647	26,00	269	565/2	8016604805653	3,00	329	584/3	8016604705847	10,50	289
503	8016604005039	54,70	104	565/2	8016604805653	3,00	329	584/4	8016604605840	6,85	289
504	8016604005046	57,10	104	565/3	8016604705656	9,50	289	585	8016604005855	244,00	42
505	8016604005053	61,60	104	565/3	8016604705656	9,50	295	586	8016604005862	50,00	40
508	4964590040029	88,50	104	565/3	8016604705656	9,50	296	586	8016604005862	50,00	65
509	8016604005091	101,50	104	565/3	8016604705656	9,50	308	600	8016604006005	50,20	105
510	8016604005114	89,30	104	565/3	8016604705656	9,50	329	6001	4033119001046	17,20	269
5104	8016604051043	39,15	22	565/3	8016604705656	9,50	329	6001/BL	4033119001237	18,30	269

Art.	EAN	€	pag.	Art.	EAN	€	pag.	Art.	EAN	€	pag.	Art.	EAN	€	pag.
6002	4033119001510	3,75	269	610	8016604906107	293,00	58	615/7	8016604306150	5,00	295				
6003	4033119002067	3,00	269	610/1	8016604806100	18,05	308	615/8	8016604206153	14,00	295				
6004/04	4033119002173	7,30	269	610/10	8016604706110	23,25	308	615/9	8016604106156	134,00	295				
6004/07	4033119002326	7,30	269	610/11	8016604606113	12,00	308	616	8016604006166	332,00	40				
6007	4033119002555	23,60	269	610/12	8016604506116	5,00	308	616	8016604006166	332,00	45				
6008	4033119002104	1,45	269	610/13	8016604406119	8,75	308	617	8016604006173	392,00	40				
6009	4033119002227	4,60	269	610/2	8016604706103	2,70	308	617	8016604006173	392,00	45				
6010	4033119002562	10,45	269	610/3	8016604606106	24,10	308	618	8016604006180	540,00	40				
6012	4033119002074	1,95	269	610/4	8016604506109	2,70	308	618	8016604006180	540,00	44				
6013	4033119004078	45,80	269	610/5	8016604406102	53,00	308	619	8016604006197	468,00	40				
6015	4033119002081	1,50	269	610/6	8016604306105	25,60	308	619	8016604006197	468,00	44				
6016	4033119002166	6,25	269	610/8	8016604106101	30,75	308	619/1	8016604906190	14,50	293				
6018	4033119002098	1,85	269	610/9	8016604806117	9,60	308	619/2	8016604806193	3,20	293				
603	8016604006036	93,40	105	6104	8016604061042	63,30	24	619/3	8016604706196	14,95	293				
604	8016604006043	100,50	105	6107	8016604061073	63,30	24	619/4	8016604606199	101,50	293				
605	8016604906053	40,00	105	6109	8016604061097	80,90	24	619/5	8016604506192	7,50	293				
605	8016604906053	40,00	239	611	8016604906114	323,00	58	619/6	8016604406195	5,15	293				
606	8016604906060	128,00	102	611/1	8016604306112	19,70	308	619/7	8016604306198	6,65	293				
606/1	8016604806063	12,45	327	611/2	8016604206115	29,50	295	621	8016604006210	548,00	40				
606/1	8016604806063	12,45	328	611/2	8016604206115	29,50	308	621	8016604006210	548,00	42				
606/10	8016604806070	2,30	327	611/3	8016604106118	60,90	308	622	8016604006227	337,00	47				
606/11	8016604706073	12,80	327	612/1	8016604806124	27,50	296	623	8016604006234	342,00	47				
606/12	8016604606076	5,95	327	612/1	8016604806124	27,50	297	624	8016604006241	1120,00	40				
606/12	8016604606076	5,95	328	612/10	8016604506130	12,50	296	624	8016604006241	1120,00	43				
606/13	8016604506079	23,40	327	612/10	8016604506130	12,50	297	624/1	8016604906244	4,15	291				
606/13	8016604506079	23,40	328	612/11	8016604306136	91,70	296	624/11	8016604806230	7,60	291				
606/14	8016604406072	3,90	327	612/11	80166043061										

Art.	EAN	€	pag.	Art.	EAN	€	pag.	Art.	EAN	€	pag.	Art.	EAN	€	pag.	Art.	EAN	€	pag.	Art.	EAN	€	pag.
627/2	8016604806278	1,45	303	72	8016604000720		265	8104	8016604081040	66,80	26	9646	8016604096464	21,50	241	F-12621	8016604126246	3,25	280	M-377	8016604903779	15,55	274
627/3	8016604706271	5,85	303	72080	8016604720802	95,40	94	8107	8016604081071	66,80	26	9650	8016604096501	13,50	209	F-13521	8016604135231	8,80	281	M-509	8016604605093	5,60	278
627/4	8016604606274	9,65	303	72081	8016604720819	95,40	94	8109	4033119000728	89,30	26	9651	8016604096518	10,60	209	F-13527	8016604135293	8,60	281	M-510	8016604605109	16,30	278
627/5	8016604506277	1,15	303	72100	8016604721007	97,80	94	82	8016604900822		223	9652	8016604096525	13,80	209	F-1419	8016604714191	1,80	281	M-517	8016604905179	34,50	279
627/6	8016604406270	2,65	303	72101	8016604721014	97,80	94	82	8016604900822		264	9809	4033119005082	45,50	31	F-14527	8016604145292	10,00	281	M-519	8016604905193	5,80	279
627/7	8016604306273	1,45	303	7230	8016604200854	37,80	95	85	8016604000850		39	9912	4033119003217		31	F-14527	8016604145292	10,00	330	M542	8016604205422	36,20	278
627/8	8016604206276	68,30	303	7232	8016604072321	37,10	95	86	8016604000867		61	9975	4033119003538		31	F-502	8016604905025	14,40	278	M-7242	8016604672422	2,80	276
627/9	8016604106279	4,65	303	7236	8016604072369	64,70	94	87	8016604000874		59	A-342	8016604503429	8,10	273	F-503	8016604905032	15,00	278	P0700	8016604907005	20,30	287
628	8016604006289	66,00	41	7237	8016604072376	70,80	94	88	8016604000881		40	A-350	8016604603501	8,10	273	F-504	8016604905049	15,00	278	P-2090	8016604620904	4,20	277
628	8016604006289	66,00	53	7238	8016604072383	74,30	94	89	8016604000898		39	A-509	8016604805097	31,70	277	F-505	8016604905056	15,00	278	P2157	8016604621574	0,80	286
628	8016604006289	66,00	303	7242	8016604072420	67,10	87	9001	4033119001060	20,80	270	A-510	8016604905100	24,60	277	F-506	8016604705069	10,50	278	P-254	8016604802546	15,80	281
629	8016604006296	500,00	40	7242	8016604072420	67,10	95	9001/BL	4033119001244	21,80	270	B-11518	8016604115202	2,75	280	F-507	8016604905070	10,80	278	P-255	8016604902550	15,80	281
629	8016604006296	500,00	43	7244	8016604072444	19,10	87	9002	4033119001534	29,20	270	B-12621	8016604126239	6,55	280	F-508	8016604905087	17,30	278	P260	8016604802607	41,50	281
629/1	8016604906299	4,00	290	7246	8016604072468	14,10	87	9007	4033119002579	24,85	270	B-20020	8016604200212	4,00	277	F-509	8016604705090	19,20	278	P260	8016604802607	41,50	337
629/10	8016604906282	41,95	290	7248	8016604072482	58,20	94	9008	4033119002111	3,30	270	B-2022	8016604920226	6,20	277	F-510	8016604705106	19,20	278	P-342	8016604703423	0,20	274
629/11	8016604806285	104,00	290	7250	8016604072505	61,60	94	9050	801660490509	6,40	87	B-2023	8016604920233	9,40	276	F-601	8016604606014	14,40	278	P-343	8016604703430	0,20	274
629/12	8016604706288	5,35	290	7252	8016604072529	62,10	94	9080	801660490806	13,70	87	B-2092	8016604920929	26,40	275	F-603	8016604506031	16,30	278	P-350	8016604703508	0,20	274
629/13	8016604606281	10,65	290	73	8016604000737		265	9081	801660490813	7,70	184	B-2094	8016604920943	10,50	276	F-604	8016604906046	22,20	278	P-352	8016604703522	0,20	274
629/2	8016604806292	6,50	290	74	8016604000744		265	9082	801660490820	7,80	63	B-252	8016604902529	58,80	338	F-751	8016604907517	7,50	286	P-362	8016604903625	5,50	274
629/3	8016604706295	40,65	290	740	8016604007408	26,10	188	9083	801660490837	8,25	63	B-257	8016604902567	104,00	321	G-253	8016604902536	12,60	282	P-364	8016604703645	5,80	274
629/4	8016604606298	191,50	290	741	8016604007415	24,75	188	9084	801660490844	2,35	272	B-341	8016604803413	4,50	274	G-255	8016604802553	13,00	283	P-368	8016604703683	0,20	274
629/5	8016604506291	38,60	290	742	8016604007422	24,60	188	9085	801660490851	9,40	63	B-342	8016604603426	1,90	273	G-260	8016604702600	21,70	282	P-376	8016604403767	1,65	274
629/6	8016604406294	11,55	290	743	8016604007439	26,20	187	9086	801660490868	14,30	62	B-343	8016604803437	8,10	273	G-260	8016604702600	21,70	336	P-378	8016604703782	1,65	274
629/7	8016604306297	15,15	290	744	8016604007446	27,45	187	9087	801660490875	25,95	62	B-350	8016604803505	0,40	274	G-260	8016604702600	21,70	337	P-7252	8016604572524	4,20	276
629/8	8016604506284	17,50	290	745	8016604007453	30,55	187	9104	801660491049	71,00	27	B-352	8016604803529	8,10	273	G-2906	8016604929069	4,50	281	R0700		22,30	287
629/9	8016604106293	32,50	290	746	8016604007460	15,20	187	9107	801660491070	71,00	27	B-362	8016604803628	9,10	274	G-291	8016604502910	1,40	283	R-11518	8016604115196	17,95	280
64	8016604000645		81	747	8016604007477	17,70	187	9109	801660491094	86,10	27	B-363	8016604803635	4,90	274	G-7252	8016604672521	12,30	276	R-12518	8016604125195	20,85	280
69001	4033119220010	43,20	272	748	8016604007484	28,70	188	92	8016604000928		41	B-376	8016604603761	6,60	274	H-363	8016604903632	11,00	274	R-12521	8016604125225	23,25	280
69002	4033119220027	16,40	272	749	8016604007491	21,00	188	93	8016604000935		41	B-601	8016604806018	1,40	278	L-2090	8016604420900	22,80	276	R-12621	8016604126222	20,05	280
69013	4033119220133	35,80	272	75	8016604000751		263	933	8016604009334	8,80	86	B-603	8016604606038	25,40	277	L2157	8016604821578	5,80	286	R-13521	8016604135224	23,25	280
69050	4033119220508	108,50	30	750	8016604007507	23,70	188	934	8016604009341	9,80	86	B-72080	8016604720833	22,20	276	L-322	8016604903229	11,70	273	R-13524	8016604135255	26,55	280
69065	4033119220652	112,50	30	751	8016604007514	14,40	187	9610/1	8016604996108	80,00	287	B-7230	8016604872303	10,50	276	L-323	8016604903236	12,80	273	R-13527	8016604135286	28,25	280
69080	4033119220805	116,50	30	752	8016604007521	24,00	180	9610/2	8016604896101	1,00	287	B-7236	8016604972379	7,70	276	L-341	8016604903410	14,80	273	R-13530	8016604135316	30,10	280
69100	4033119221000	120,50	30	752/1	8016604907524	6,00	285	9610/3	8016604796104	1,40	287	B-7242	8016604872426	6,10	276	L-342	8016604903427	13,90	273	R-1419	8016604814198	15,40	280
69150	4033119205020	108,50	29	752/2	8016604807527	0,80	285	9610/4	8016604696107	0,25	287	B-7252	8016604772528	8,70	276	L-343	8016604903434	13,90	273	R-14527	8016604145285	25,35	280
7	8016604000072		264	753	8016604007538	30,10	180	9610/5	8016604596100	3,15	287	C-2092	8016604720925	12,10	276	L-344	8016604903441	13,00	273	R-14533	8016604145346	27,45	280
70001	4033119200012	40,10	272	754	8016604007545	46,55	181	9610/6	8016604496103	0,90	287	C-252	8016604102530	49,50	321	L-345	8016604803451	0,40	273	R-14533	8016604145346	27,45	330
70002	4033119200029	14,20	272	754/1	8016604907548	9,20	285	9610/7	8016604396106	3,85	287	C-252	8016604102530	49,50	338	L-350	8016604903502	13,00	273	R-1505	8016604915055	18,30	280
70004	4033119200043	13,50	272	755	8016604007552	27,75	182	9610/9	8016604196102	304,00	287	C-291	8016604602917	10,60	284	L-352	8016604903526	14,50	273	R-1506	8016604915062	23,10	280
70005	4033119200050	17,55	272	755/1	8016604907555	12,50	286	9618	8016604906181	16,50	209	C-335	8016604903557	11,00	274	L-362	8016604603624	11,90	273	R-1512	8016604915123	16,30	280
70008	4033119200081	6,95	272	756	8016604007569	33,20	182	9622	8016604906228	11,20	212	C-341	8016604703416	11,00	274	L-363	8016604703638	12,80	273	R-1513	8016604915130	20,20	280
7001	4033119001350	17,45	270	757	8016604007576	28,75	183	9623	8016604906235	5,10	212	C-364	8016604803642	5,90	273	L-364	8016604903649	12,80	273	R-1514	8016604915147	18,60	280
7001/BL	4033119001343	18,40	270	757/1	8016604907579	13,30	286	9624	8016604906242	13,00	212	C-367	8016604703676	11,00	274	L-367	8016604803673	14,60	273	R-1515	8016604915154	20,20	280
70011/100	4033119200234	63,10	272	758	8016604007583	34,20	183	9625	8016604906259	11,50	213	C-513	8016604905131	10,00	279	L-371	8016604903717	14,80	273	R-15533	8016604155345	22,55	280
70012	4033119200128	7,00	272	759	8016604007590	24,70	188	9627	8016604906273	11,80	209	C-72080	8016604720840	18,90	275	L-376	8016604803765	31,30	273	R-20010	8016604200113	24,20	276
70013	4033119200135																						

Art.	EAN	€	pag.	Art.	EAN	€	pag.	Art.	EAN	€	pag.
R-26201	8016604262210	11,40	285	R-71	8016604900716	2,20	286	S-3906/7		1,30	341
R-26202	8016604262227	12,10	285	R-72	8016604900723	1,50	286	S-3906/7		1,30	342
R-26203	8016604262234	2,50	285	R-72080	8016604720864	29,60	275	S-3906/8		1,30	341
R-292		0,70	281	R-72081	8016604720871	37,35	275	S-3906/8		1,30	342
R-332	8016604903328	0,70	274	R-7236	8016604972362	19,10	276	S-3906/9		0,90	341
R-334	8016604903342	0,70	275	R-7242	8016604972423	18,60	276	S-3906/9		0,90	342
R-339	8016604903397	0,60	275	R-7244	8016604872440	10,80	273	S-3906/9		0,90	343
R-340	8016604903403	1,30	275	R-7252	8016604972522	19,20	276	S-3907/12		18,80	342
R-342	8016604803420	2,20	275	R-73	8016604900730	1,70	286	S-3907/13		73,30	342
R-345	8016604903458	0,60	275	R-74	8016604900747	0,90	286	S-3907/14		50,90	342
R-34520	8016604345210	0,60	275	R-75	8016604900754	0,10	286	S-3907/16		10,40	342
R-347	8016604903472	0,60	275	R-76	8016604900761	2,60	286	S-3907/19		61,70	342
R-348	8016604903489	0,70	275	R-77	8016604900778	2,00	286	S-3907/2		2,30	342
R-349	8016604903496	0,80	275	R-78	8016604900785	1,00	286	S-3907/30	8016604939075	4,10	342
R-35522	8016604355233	0,60	275	R-79	8016604900792	1,20	286	S-3907/31	8016604839078	2,10	342
R-35625	8016604356261	0,60	275	R-80	8016604900808	1,40	286	S-3908/1	8016604139116	23,70	343
R-371	8016604803710	1,40	275	R-81	8016604900815	8,60	286	S-3908/10	8016604039126	18,00	343
R-372	8016604903724	1,00	275	R-82		16,30	286	S-3908/11	8016604139123	22,80	343
R-376	8016604703768	2,75	275	S2157	8016604721571	4,80	286	S-3908/12	8016604239120	0,90	343
R-380	8016604993800	2,40	275	S-291	8016604702914	6,30	283	S-3908/13	8016604339127	1,30	343
R-382	8016604903823	1,70	275	S-376	8016604503764	5,80	274	S-3908/14	8016604439124	2,10	343
R-392	8016604903922	0,30	274	S-378	8016604803789	5,80	274	S-3908/15	8016604539121	2,10	341
R-393	8016604903939	0,40	274	S-3906/1		2,80	341	S-3908/15	8016604539121	2,10	343
R-510	8016604505102	2,60	278	S-3906/1		2,80	342	S-3908/16	8016604639128	2,80	343
R-512	8016604905124	6,20	279	S-3906/10		2,10	341	S-3908/17	8016604739125	2,80	343
R-514	8016604905148	21,50	279	S-3906/10		2,10	342	S-3908/18	8016604839122	1,10	343
R-515	8016604095153	12,60	279	S-3906/11		2,10	341	S-3908/19	8016604939129	1,10	343
R-516	8016604805165	29,10	279	S-3906/11		2,10	342	S-3908/2	8016604239113	92,40	343
R-517	8016604095177	12,60	279	S-3906/12	8016604739064	3,60	341	S-3908/20	8016604039133	3,90	343
R-530	8016604905308	9,70	279	S-3906/12	8016604739064	3,60	342	S-3908/21	8016604139130	0,60	343
R-531	8016604905315	5,10	279	S-3906/13		2,30	341	S-3908/22	8016604239137	2,10	343
R-532	8016604905322	9,00	279	S-3906/13		2,30	342	S-3908/23	8016604339134	2,10	343
R-534	8016604905346	11,80	279	S-3906/14		2,80	341	S-3908/24	8016604439131	5,80	343
R-535	8016604905353	7,80	279	S-3906/14		2,80	342	S-3908/25	8016604539138	9,10	343
R-537	8016604905377	1,50	279	S-3906/14		2,80	344	S-3908/26	8016604639135	10,40	343
R-538	8016604905384	11,70	279	S-3906/15		29,00	341	S-3908/27	8016604739132	2,70	343
R-542	8016604905421	7,00	278	S-3906/16		18,00	341	S-3908/3	8016604339110	116,00	343
R-542/1	8016604805424	7,50	279	S-3906/17		18,80	341	S-3908/30	8016604939082	3,30	343
R-542/2	8016604705427	2,70	279	S-3906/18		32,70	341	S-3908/31	8016604839139	11,40	343
R-542/3	8016604605420	9,10	279	S-3906/19		2,70	341	S-3908/4	8016604439117	22,80	343
R-542/4	8016604505423	6,70	279	S-3906/2		2,30	341	S-3908/5	8016604539114	25,80	343
R-542/5	8016604405426	7,00	279	S-3906/20		15,00	341	S-3908/6	8016604639111	10,40	343
R-542/6	8016604305429	8,20	279	S-3906/21	8016604639067	25,20	341	S-3908/7	8016604739118	10,40	343
R-55	8016604900556	1,80	286	S-3906/21	8016604639067	25,20	342	S-3908/8	8016604839115	65,30	343
R-56	8016604900563	0,70	286	S-3906/22		77,20	341	S-3908/9	8016604939112	19,50	343
R-57	8016604900570	1,80	286	S-3906/22		77,20	342	S-506	8016604605062	5,40	278
R-58	8016604900587	2,20	286	S-3906/22C	8016604839061	7,50	341	S531	8016604805318	24,20	278
R-59	8016604900594	13,10	286	S-3906/23		52,50	341	S532	8016604805325	29,00	278
R-60	8016604900600	7,00	286	S-3906/23S		3,80	341	S537	8016604805370	19,40	278
R-601	8016604906015	31,10	278	S-3906/24		69,60	341	S538	8016604805387	33,90	278
R-603	8016604406034	13,70	278	S-3906/24		69,60	342	S542	8016604105425	36,20	278
R-61	8016604900617	2,00	286	S-3906/25	8016604539060	19,90	341	T-255	8016604702556	8,00	283
R-62	8016604900624	2,90	286	S-3906/26		34,70	341	V-255	8016604502576	4,00	281
R-63	8016604900631	1,30	286	S-3906/27		10,40	341	V-258	8016604802584	4,70	281
R-64	8016604900648	11,00	286	S-3906/28		16,50	341	V-291	8016604802911	3,90	283
R-65	8016604900655	0,60	286	S-3906/3		2,10	341	V-603	8016604306037	2,00	278
R-66	8016604900662	1,50	286	S-3906/4		2,10	341				
R-67	8016604900679	18,90	286	S-3906/4		2,10	342				
R-68	8016604900686	3,60	286	S-3906/5		1,50	341				
R-69	8016604900693	3,60	286	S-3906/5		1,50	342				
R-70	8016604900709	1,30	286	S-3906/6		1,50	341				